

Bruker BioSpin

# BLAH1000 E

Amplifier 700-900MHz INR OTR  
Operating & Service Manual

Version 001

think forward

NMR Spectroscopy

The information in this manual may be altered without notice.

BRUKER BIOSPIN accepts no responsibility for actions taken as a result of use of this manual. BRUKER BIOSPIN accepts no liability for any mistakes contained in the manual, leading to coincidental damage, whether during installation or operation of the instrument. Unauthorised reproduction of manual contents, without written permission from the publishers, or translation into an other language, either the entire manual or a part of it, is forbidden.

This manual describes the units as they are at the date of printing. On request, the manufacturer shall supply circuit diagrams, lists of components, descriptions, calibrating instructions and any other information for use by qualified personnel of the user, in charge of repairing the parts of the unit which have been stated by the manufacturer to be "repairable". Such supply shall in no event constitute permission to modify or repair the units or approval of the same.

All rights reserved for the units, circuits, processes and appellations mentioned herein.

This unit is not designed for any type of use which is not specifically described in this manual. Such use may be hazardous.

This manual was written by

[Bernard Geissert](#)

This manual was edited and desktop published by

[Dominique Wurtz](#)

© November 4, 2009: Bruker BioSpin

Wissembourg, France

P/N: Z31867

DWG-Nr: Z4D10858

For further technical assistance on the BLAH1000 E unit, please do not hesitate to contact your nearest BRUKER dealer or contact us directly at:

BRUKER BioSpin  
34 rue de l'Industrie  
F-67166 Wissembourg Cedex  
France

Phone: + 33 388 066 000  
Fax: + 33 388 736 820  
Email: [support-rmn@bruker.fr](mailto:support-rmn@bruker.fr)  
Internet: [www.bruker.com](http://www.bruker.com)

# Contents

	<b>Contents .....</b>	<b>3</b>
<b>1</b>	<b>General Information .....</b>	<b>5</b>
1.1	Introduction .....	5
<b>2</b>	<b>Safety .....</b>	<b>7</b>
2.1	Identification Labels .....	7
	Identifying Plate .....	7
	Manufacturer's Name Plate .....	8
	Safety Labels and Symbols .....	8
	Warning Signs .....	8
	Risk of Danger .....	8
	Operating Instruction .....	8
<b>3</b>	<b>Installation .....</b>	<b>9</b>
3.1	Initial Inspection .....	9
	Mechanical Check .....	9
	Claim for Damage .....	9
	Reshipment and Repackaging Requirements .....	9
	Environment Requirements .....	10
3.2	Installation Requirements .....	10
	Bench Operation .....	10
3.3	Power Requirements .....	10
3.4	System Check .....	10
3.5	Initial Turn on Procedure .....	11
<b>4</b>	<b>Operation .....</b>	<b>13</b>
4.1	Front Panel Description .....	13
	Indicators .....	13
	Coaxial Connectors .....	14
	Ethernet 10/100 Interface Connector .....	14
	Device Front View .....	15
4.2	Rear Panel Description .....	16
	Power Supply Connector .....	16
	Device Rear View .....	17
4.3	External Power Supply .....	18
	Front Panel & Indicators Description .....	18
	Device Rear View .....	18
	Rear Panel Description .....	19
	Device Rear View .....	19

<b>5</b>	<b><i>Technical Description</i></b> .....	<b>21</b>
5.1	System Overview .....	21
5.2	Theory of Operation .....	26
	RF Path .....	26
	Embedded Input Router .....	26
	RF Driver .....	26
	RF Relays H1000/H100 Selection .....	27
	RF Splitter .....	27
	RF Power Amplifier .....	27
	RF Combiner .....	27
	RF Coupler .....	28
	Output Router .....	28
	Isolators .....	28
	BLA Control Board .....	28
	BLA Extension Board .....	30
	Status Led Board .....	30
	BIS Board .....	30
	Supply Status Board .....	31
<b>6</b>	<b><i>Servicing the BLA</i></b> .....	<b>33</b>
6.1	Accessing the BLA Amplifier .....	33
6.2	Sub Toolbar Information .....	34
	Device Information (default) .....	34
	Amplifier Status .....	35
6.3	Sub Toolbar Advanced Operations .....	36
	Device Information (advanced) .....	36
	Amplifier Limitations .....	37
	Change Limits .....	38
	Routing Information and Setting .....	39
6.4	Sub Toolbar Maintenance .....	40
	Device Information (maintenance) .....	40
	Self-Test & Software Reset .....	41
	Firmware Update .....	43
	BIS Content .....	44
<b>7</b>	<b><i>Specifications</i></b> .....	<b>45</b>
7.1	Common Characteristics .....	45
7.2	General Specifications .....	46
	Channel High Resolution 100W Output .....	46
	Channel Solid 1000W Output .....	47
<b>8</b>	<b><i>Service Information and Maintenance</i></b> .....	<b>49</b>
8.1	Preventive Maintenance of the RF Module on BLA-Type Amplifiers ..	49
	Operation .....	49
	<b><i>Figures</i></b> .....	<b>51</b>
	<b><i>Tables</i></b> .....	<b>53</b>

# General Information

# 1

## Introduction

## 1.1

The BLAH1000 E Amplifier 700-900MHz INR OUTF is a broadband linear pulse power amplifier specifically designed for Nuclear Magnetic Resonance (NMR) and Magnetic Resonance Imaging (MRI) applications for 16,4 to 21,1 Teslas Systems. It is commercialized under the BRUKER BIOSPIN part number W1345531.

It is operated in AB linear class and provides 1000W and more peak RF power over the frequency range 650-900MHz on the 1000W channel for the Solid applications and 100W and more peak RF power on the 100W channel for the High Resolution applications. Also, it is provided with a mechanical RF relay to ensure HPLNA compatibility output routing, see more in "**Output Routing Block Diagram**" on page 22.

The amplifier is equipped with **N-Channel RF LDMOSFETs** transistors of the latest generation. The unit can provide full power for any combination of pulse width and duty cycle up to 100ms and 25% in High Resolution mode and 5% in Solid mode.

Its built-in protection circuitry will allow lower power pulses for longer pulse widths and duty-cycles, maintaining a 50W average power for the Solid application and a 25W average power for the High Resolution application on MAIN OUT or AUX OUT outputs.

The electronic protection circuitry has been designed to protect against:

- Excessive power output level (overdrive)
- Excessive pulse repetition rate (over duty-cycle protection)
- Excessive pulse duration (over pulse-width)
- More than 50% reflected RF power (mismatch when  $VSWR \geq 6$ )
- Thermal protection (overheat)

The amplifier is powered by an external switched power supply assembly that provides the +32VDC for the power amplifiers, in addition to all low level voltages for the system.

The supply is self protected for overcurrent and overvoltage.

The amplifier is housed in a 19", 3U, 520mm deep rack cabinet and is powered by an external switched power supply assembly housed in a 19", 2U, 480mm deep rack cabinet.

**General Information**



---

The BLAH1000 E Amplifier 700-900MHz is in accordance with the standard 61010-1 and with the UL 61010-1 / CSA C22.2 No.61010-1-04 Safety Requirements for Electrical Equipments.

---

## Identification Labels

2.1

Labels are provided to alert operating and service personnel to conditions that may cause personal injury or damage to the equipment from misuse or abuse. Please read the labels and understand their meaning.

### Identifying Plate

2.1.1

The BLAH1000 E Amplifier 700-900MHz can be identified by an identifying plate at the front panel of the unit that contains the following information :

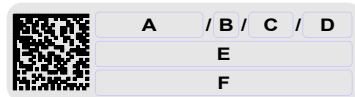

Figure 2.1. Identifying Plate

- **(A) Part Number**  
This field indicates the part number of the product.
- **(B) Variant**  
This field indicates the variant number that identifies the production category of the product. The default variant is 00.
- **(C) ECL**  
This field indicates the revision number that identifies the product configuration. The initial revision is 0.00.
- **(D) Serial Number**  
This field indicates the serial number of the product.
- **(E) Type**  
This field contains the designation of the product.
- **(F) Information**  
This field contains additional information about the product.

### Manufacturer's Name Plate

2.1.2

The BLAH1000 E Amplifier 700-900MHz can be identified by a manufacturer's name plate at the back panel of the unit that contains the country of origin of manufacture.

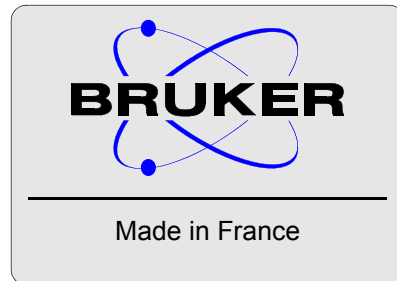

Figure 2.2. Manufacturer's Name Plate

### Safety Labels and Symbols

2.1.3

### Warning Signs

2.1.4

#### Risk of Danger



#### **DANGER! Risk of electrical shocks**

Throughout this manual, this symbol indicates the possibility of severe personal injury, loss of life or equipment damage if the instructions are not followed.

On the equipment, the symbol also implies a danger and alerts the user.

#### **Operating Instruction**

Operating personal should not remove RF output cable without turn off the power supply because the RF output can cause serious burns before the "Mismatch" protection is active.

Please disconnect the mains supply before opening to prevent potential hazard such as :

- Electrical shock from power supply
- Contact burns from the RF module and heatsink
- Finger scratch due to the fan assembly on the RF module.



# Installation

# 3

The installation of the device must be done only by an authorized and qualified technician, in total accordance with the running standards.

BRUKER BIOSPIN assumes no liability for the customer's failure to comply with these requirements and is therefore not responsible or liable for any injury or damage that occurs as a consequence of non-approved installation.

## **Initial Inspection** **3.1**

---

### **Mechanical Check** **3.1.1**

---

If damage of the shipping cardboard is evident, request the carrier's agent to be present when the instrument is unpacked. Check the equipment for damage and inspect the cabinet and panel surfaces for dents and scratches.

### **Claim for Damage** **3.1.2**

---

If the unit is mechanically damaged or fails to meet specifications upon receipt, notify BRUKER or our representative immediately. Retain the shipping cardboard and packing material for the carriers inspection as well as for subsequent use in returning the unit if necessary.

### **Reshipment and Repackaging Requirements** **3.1.3**

---

Whenever possible, the original cardboard and packing material should be used for reshipment. If the original packing material is not available, wrap the instrument in heavy paper or plastic. Use a strong shipping container. If cardboard is used, it should be at least 200 lbs. test material.

Use shock absorbing material around all sides of the instrument to provide a firm cushion and to prevent movement from inside the container wall on each side. Protect the front panel by means of cardboard spacers inserted between the front panel and the shipping cardboard. Make sure that the instrument cannot move in the container during shipping. Seal the cardboard box with a good grade of shipping tape and mark the container :

**"FRAGILE ELECTRONIC INSTRUMENT"**

## Installation

### **Environment Requirements**

**3.1.4**

This amplifier is built for inside use only on a maximum elevation of 2000m above sea level (6600 feet).

No specific cooling or ventilation is required.

Be sure that the amplifier has enough area around it so that the free air flow into and out of the amplifier is not obstructed.

It should, however, be in an environment which conforms to the 5°C - 45°C (41°F - 113°F) thermal specifications, a 80% maximum relative humidity of air and a contamination level of two (means a normal non-conductive contamination, temporary conductivity due to condensation is possible).

### **Installation Requirements**

**3.2**

No special precautions are necessary. Mount the equipment in an area which is relatively free of vibration, and has sufficient room for cable connections.

The amplifier has a class II installation category.

### **Bench Operation**

**3.2.1**

The unit can be placed onto a secure flat surface.

### **Power Requirements**

**3.3**

The BLAH1000 E Amplifier 700-900MHz is designed to be powered by an additional external switched power supply (P/N:W1304007).

The connection to this power supply is realized via an 500mm cable fitted with a 15 pins DIN 41612-ERNI female connector and coming out from the rear panel of the amplifier.

It provides all the voltages necessary to the BLAH1000 E Amplifier 700-900MHz to work. See **"External Power Supply" on page 18.**

### **System Check**

**3.4**

Before applying power for the first time the following items should be checked:

- The AC input voltage 208-230 VAC  $\pm$  10% range must be compatible with the power supply.
- An external blanking (gating) pulse must be supplied to the amplifier in order for the unit to function. Ensure that this pulse has a proper level and logic polarity.
- The BLAH1000 E Amplifier 700-900MHz has a nominal input level of +4dBm. Ensure that the system drivers are operating at these levels.
- Output RF loads are connected.

The following list describes how to turn on the BLAH1000 E Amplifier 700-900MHz and what should be seen as this occurs.

Before starting this procedure, make sure that you have properly followed the instructions in section **"System Check" on page 10**.

1. Connect together the amplifier and the external power supply, connect it to the AC line and turn the line switch to ON.
2. Observe the indicators on the front panel of the amplifier:
  - The +32V ON LED's will illuminate,
  - The +15V, -15V and +3,3V ON LED's will illuminate.
3. System is now fully operational.



# Operation

# 4

## Front Panel Description

4.1

The BLAH1000 E Amplifier 700-900MHz front panel is provided with 13 indicators for status monitoring, 7 RF connectors, 1 interface connector.

## Indicators

4.1.1

Normal operation is indicated when following LED's are ON.

Table 4.1. Indicators Assignment

+32V	Indicates that the +32V supply is applied.
+15V	Indicates that the +15V supply is applied.
-15V	Indicates that the -15V supply is applied.
+3,3V	Indicates that the +3,3V supply is applied.
Overdrive	Indicates when the peak power limit has been reached.
Duty Cycle (D.C.)	Indicates when the duty cycle limit has been reached.
Pulse Width (P.W.)	Indicates when the pulse width limit has been reached.
Mismatch	Indicates when the max. reflected power limit has been reached.
RF POW. FLT	Indicates when one of the above limits has been reached.
Overheat	Indicates that the thermistor located on the RF module heatsink has sensed excessive heatsink temperature. The amplifier is blanked until an acceptable temperature is reached. The function is self-resetting and no maintenance is needed. Indicates also that a fan on the assembly stops turning. The amplifier is blanked until fans are changed.
RF PULSE	Indicates when RF Power is present on one of the RF Output connectors.
MAIN OUT	ON indicates that the MAIN OUT 1000W/100W is active. OFF indicates that the AUX OUT 1000W/100W is active.
1000W ON	ON indicates that the 1000W channel is active. OFF indicates that the 100W channel is active.

Table 4.2. Coaxial Connectors Assignment

<b>IN1, IN2, IN3</b>	RF input of the embedded router, SMA type connector (female). Defaults entry is IN1 and allows to the BLAH1000 E to deliver full power at nominal +4dBm drive.
<b>MAIN OUT 1000W/100W</b>	RF output if MAIN OUT LED is on, N type connector (female). Default setting that allows High Resolution or Solid application based on the SEL H1000/H100 selection.
<b>AUX OUT 1000W/100W</b>	RF output if MAIN OUT LED is off, N type connector (female). Available by setting the output router that allows High Resolution or Solid application based on the SEL H1000/H100 selection.
<b>BLNK</b>	Blanking input, BNC type connector (female). TTL logic, 5V = blanking ON, 0V = blanking OFF. When BLANKING signal is at TTL level high (+5V), no gating is applied to the amplifier stages, and no RF Power is possible. When BLANKING signal is at TTL level low (0V), the amplifier stages are gated and RF Power is possible.
<b>SEL H1000/H100</b>	Select input, BNC type connector (female). When the SEL H1000/H100 signal is at TTL level low (0V), the 1000W channel for Solid application is selected. When the SEL H1000/H100 signal is at TTL level high (+5V), the 100W channel for High Resolution application is selected.

The RJ45 connector for the Ethernet 10/100 Mbps link is mounted directly on the BLA Control Board.

Table 4.3. RJ45 Pin Assignment

<b>Pin 1</b>	Transmit + (Tx+)
<b>Pin 2</b>	Transmit - (Tx-)
<b>Pin 3</b>	Receive + (Rx+)
<b>Pin 4</b>	N/A
<b>Pin 5</b>	N/A
<b>Pin 6</b>	Receive - (Rx-)
<b>Pin 7</b>	N/A
<b>Pin 8</b>	N/A

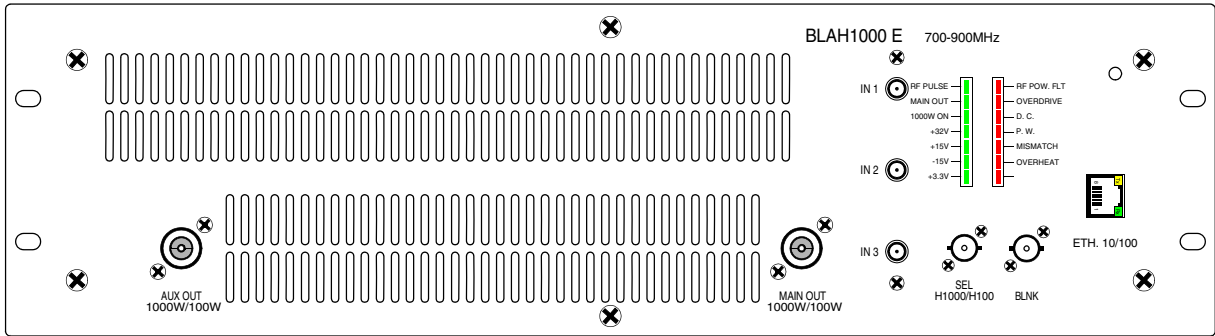

Figure 4.1. BLAH1000 E Amplifier 700-900MHz Front Panel Design

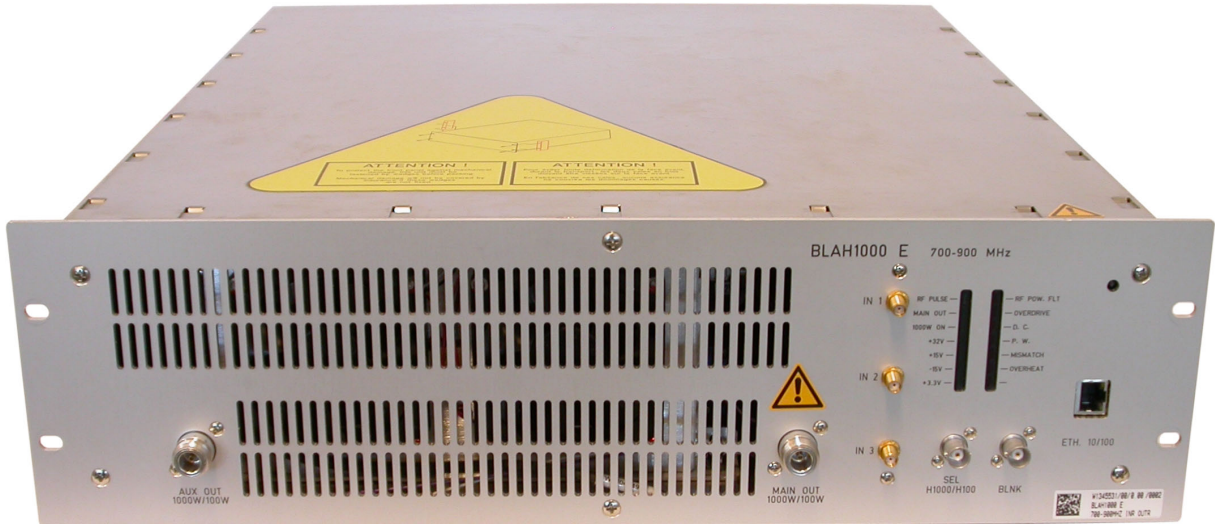

Figure 4.2. BLAH1000 E Amplifier 700-900MHz Front Panel View

**Rear Panel Description**

**4.2**

The rear panel of the BLAH1000 E Amplifier 700-900MHz has a 500mm cable fitted with a 15 pin DIN 41612-ERNI female connector, coming out of the rear panel of the amplifier.

**Power Supply Connector**

**4.2.1**

Table 4.4. DIN 41612-ERNI Pin Assignment

<b>Pin z4</b>	+3,3V	<b>Pin d6</b>	not connected
<b>Pin z8</b>	+15V	<b>Pin d10</b>	DGND
<b>Pin z12</b>	-15V	<b>Pin d14</b>	PGND
<b>Pin z16</b>	+32V	<b>Pin d18</b>	PGND
<b>Pin z20</b>	+32V	<b>Pin d22</b>	PGND
<b>Pin z24</b>	+32V	<b>Pin d26</b>	PGND
<b>Pin z28</b>	+32V	<b>Pin d30</b>	PGND
<b>Pin z32</b>	+32V		



*DGND = Digital Ground for ±15V and +3,3V*  
*PGND = Power Ground for 5 x +32V*

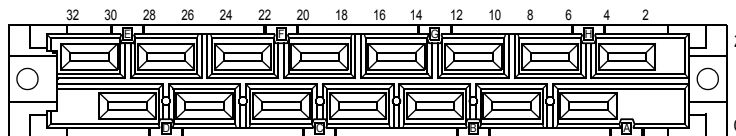

Figure 4.3. DIN 41612-ERNI Connector Design



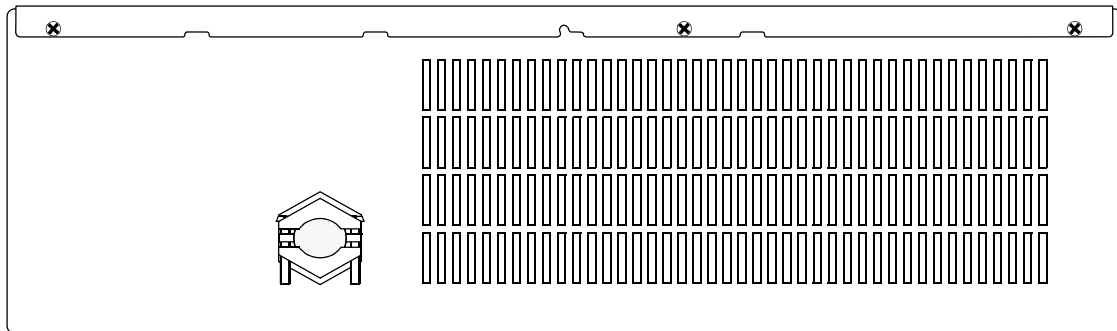

Figure 4.4. BLAH1000 E Amplifier 700-900MHz Rear Panel Design

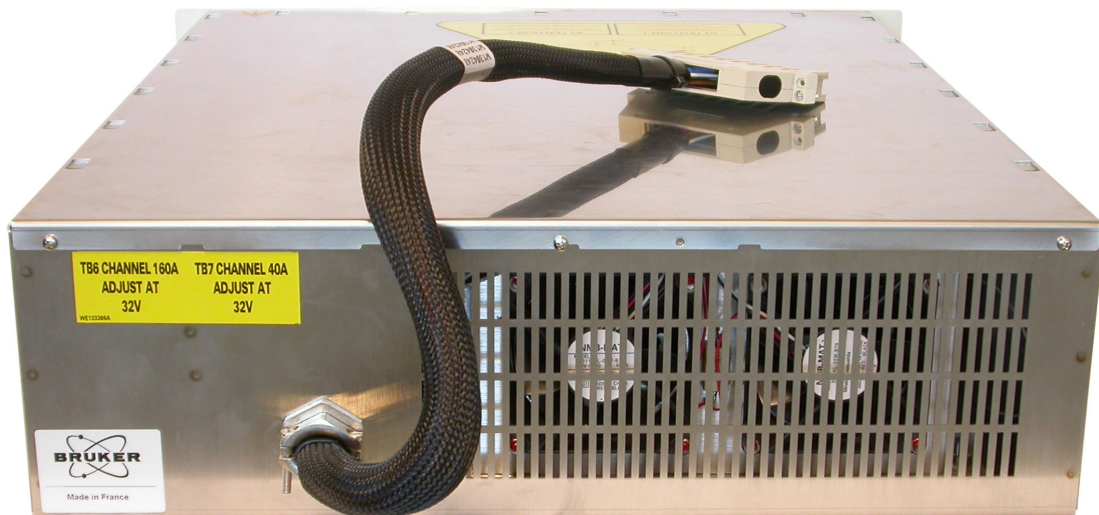

Figure 4.5. BLAH1000 E Amplifier 700-900MHz Rear Panel View

**External Power Supply**

**4.3**

The external power supply has the Bruker Part Number P/N:W1304007.

This part number has been established for identification of use by internal jumper settings.

It provides a first output voltage channel of +32Vdc, 50A maximum with a current peak of 175A maximum for 100ms pulse width and 5% duty cycle and also a second output voltage channel of +32Vdc, 18A maximum with a current peak of 45A maximum for 100ms pulse width and 10% duty cycle.

This unit provides also auxiliaries supplies of +15Vdc; 2A, -15Vdc; 0.5A and +3.3Vdc; 4A.

**Front Panel & Indicators Description**

**4.3.1**

The external Power Supply front panel is provided with 5 indicators for status monitoring.

Normal operation is indicated when following LED's are ON.

*Table 4.5. Power Supply Indicators Assignment*

<b>+28/30/32V A ON 175A</b>	Indicates that the +32V first voltage output channel supply is active. Internal setting.
<b>+28/30/32V B ON 45A</b>	Indicates that the +32V second voltage output channel supply is active. Internal setting.
<b>+12/+15V ON</b>	Indicates that the +15V supply is active. Internal setting.
<b>-15V ON</b>	Indicates that the -15V supply is active.
<b>+3,3V/+5V ON</b>	Indicates that the +3,3V supply is active. Internal setting.

**Device Rear View**

**4.3.2**

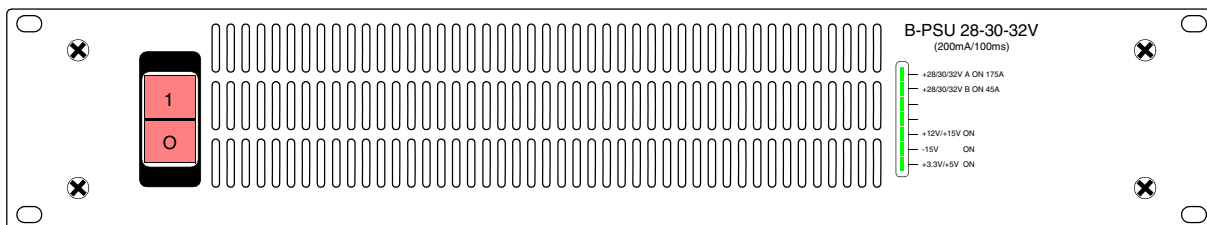

*Figure 4.6. Power Supply Front Panel Design*

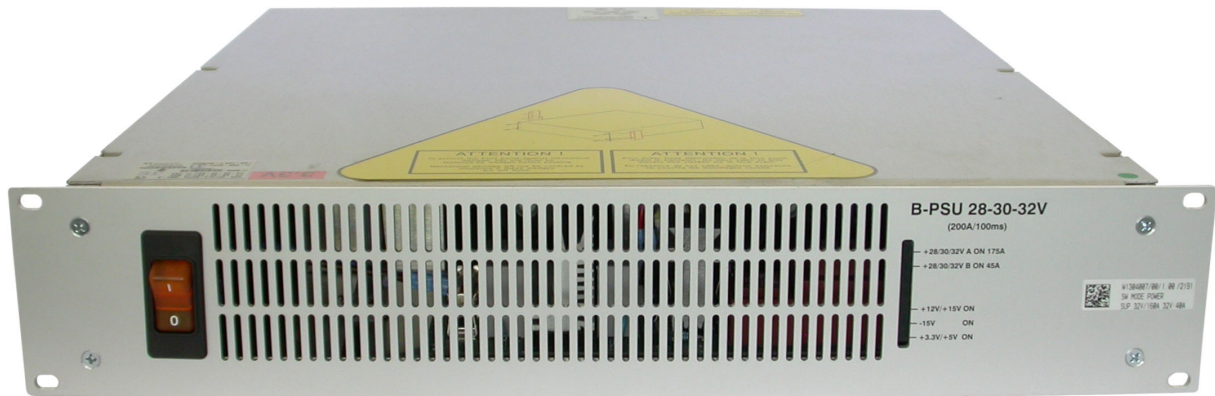

Figure 4.7. Power Supply Front Panel View

### Rear Panel Description

4.3.3

The rear panel of the external power supply is provided with a 15 pin DIN 41612-ERNI male connector.

### Device Rear View

4.3.4

Figure 4.8. Power Supply Rear Panel Design



Figure 4.9. Power Supply Rear Panel View



# Technical Description

# 5

## System Overview

## 5.1

The BLAH1000 E Amplifier 700-900MHz requires the additional Bruker Biospin Power Supply to provides :

- A RF Output of 1000W and more over the full frequency range 650-900MHz when it is selected for Solid application with SEL H1000/H100 command controlled at TTL level low. This high power channel can be put out on the MAIN OUT or the AUX OUT in function of the Topspin selection.
- A RF Output of 100W and more over the full frequency range 650-900MHz when it is selected for High Resolution application with SEL H1000/H100 command controlled at TTL level high. This low power channel can be put out on the MAIN OUT or the AUX OUT in function of the Topspin selection.

The RF section of the system consists of an embedded router fixed on the front panel and a linear module BLMH1000-E I/OR mounted around a single self-contained Push and Pull fan assembly heatsink, a bi-directional High Dynamic coupler and a mechanical output router mounted on the bottom of the amplifier housing.

The embedded router has three RF inputs and one RF output feeded to the driver amplifier located on the BLMH1000-E I/OR module.

A linear class A / AB driver using switches and bias voltage gatings, delivers the RF input power to the two power amplifiers through a 2 ways in-phase splitter, located on the left wall, when the Solid application is selected. When the High Resolution application is selected, this driver is capable to deliver 100W and more power output. It is located on the bottom of the heatsink assembly.

The two class AB power amplifiers are located on the top of the heatsink assembly and are combined by mean of a 2 ways in-phase combiner located on the right wall.

The selection of the 1000W channel or the 100W channel is made with a pair of RF power relays controlled by the SEL H1000/H100 input signal.

The output of the combiner and the driver are connected via a mechanical relay to a bi-directional high dynamic coupler.

Then the RF power passes through the output router made with a RF power relay. The selection of the MAIN OUT 1000W/100W or the AUX OUT 1000W/100W is done with a software command from Topspin.

The entire system is controlled by a Digital Signal Processing control board, processing information from the amplifier and blanking signal, providing protection from excessive peak power, duty cycle and pulse width for average power, maximum reflected power and heatsink over-temperature.

The DSP control board reads the identification information of the amplifier (BIS).

# Technical Description

Monitoring of fan status, supply status and LED's status is also performed by the control board.

Circuits such as Supply Status board, BLAC6 Extension Board 1 Channel and Status LED's board, complete the amplifier assembly.

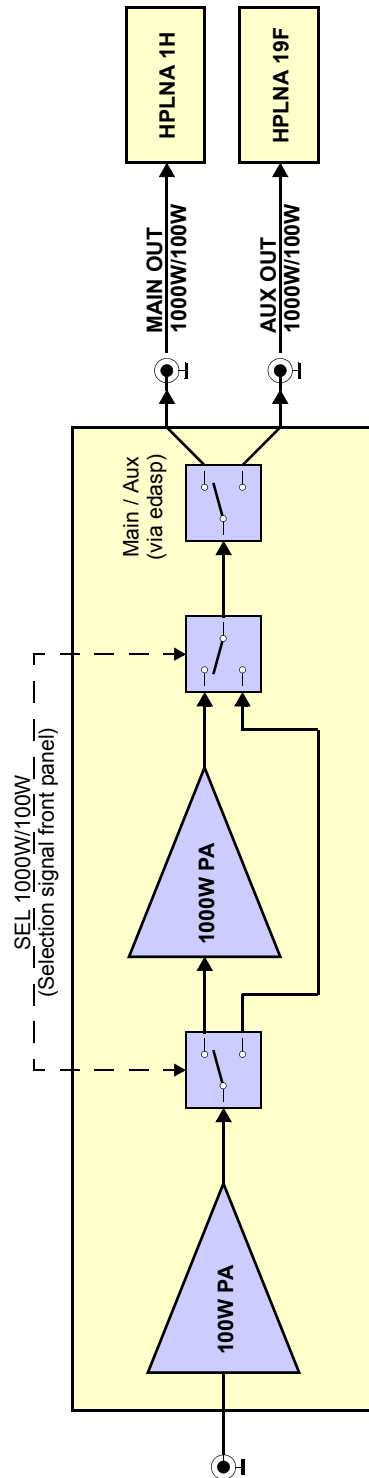

Figure 5.1. Output Routing Block Diagram

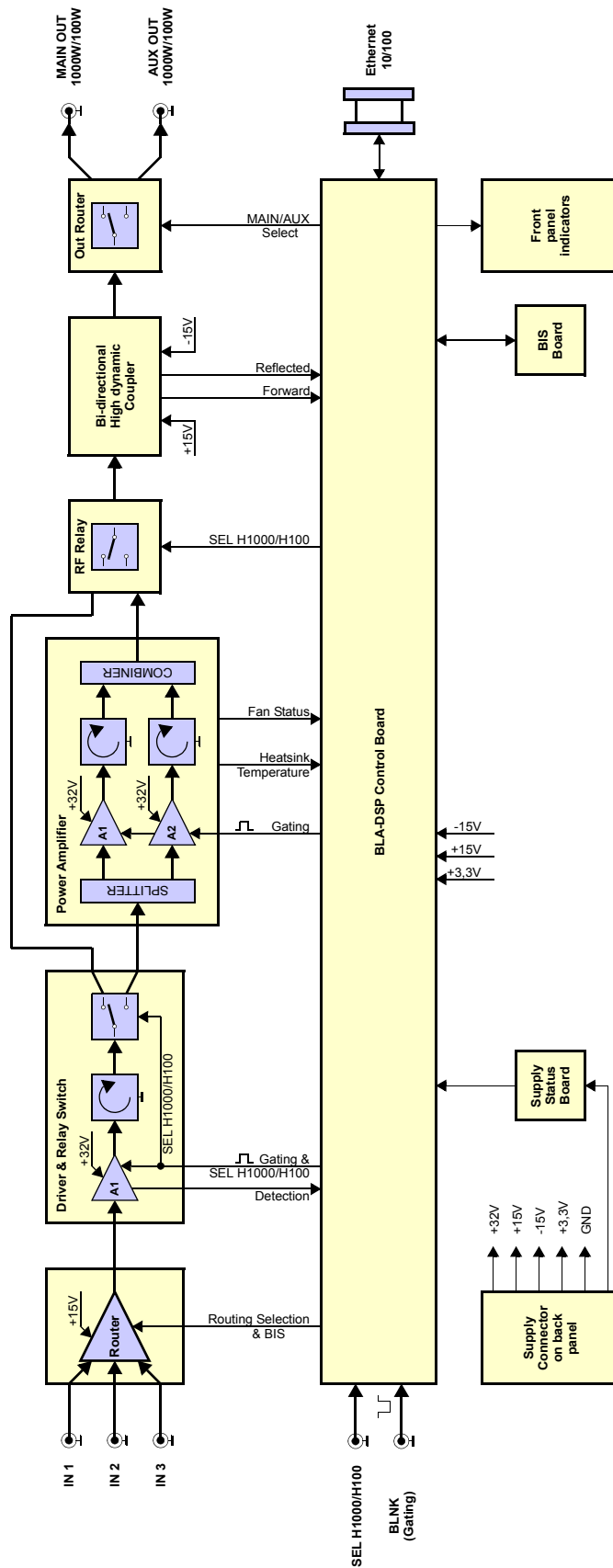

Figure 5.2. BLA-H1000 E Amplifier 700-900MHz System Block Diagram

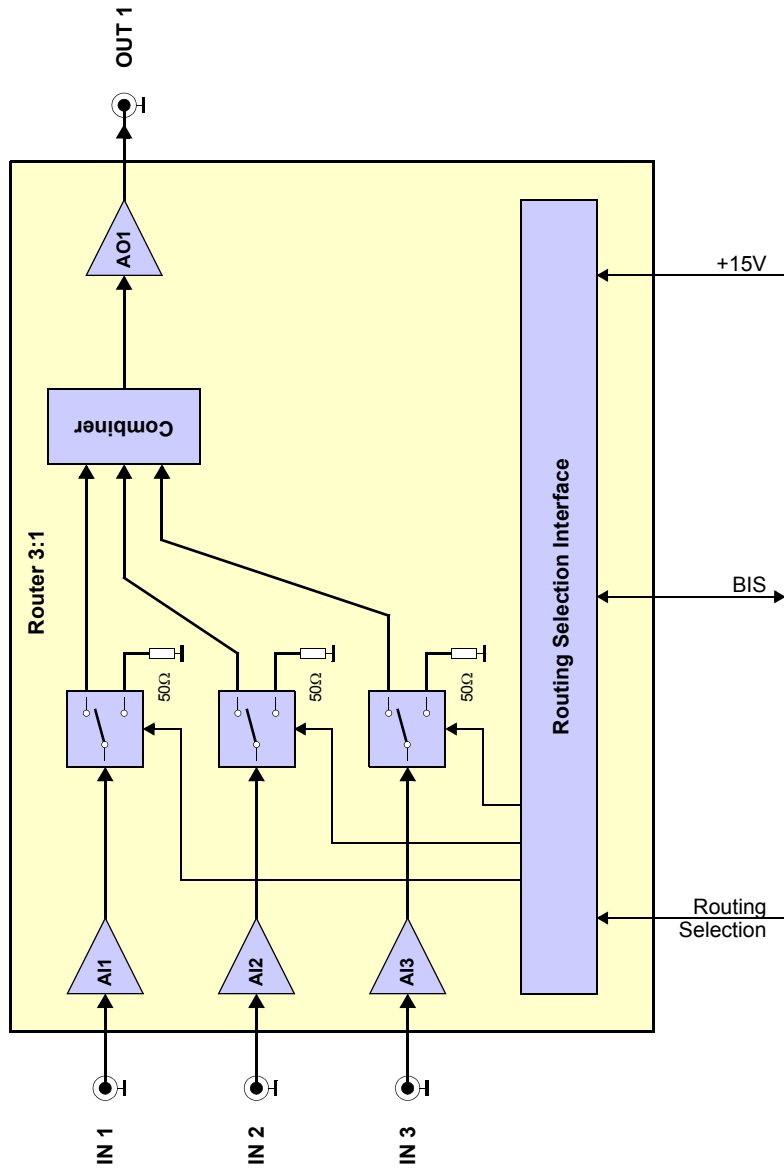

Figure 5.3. Embedded Router Block Diagram



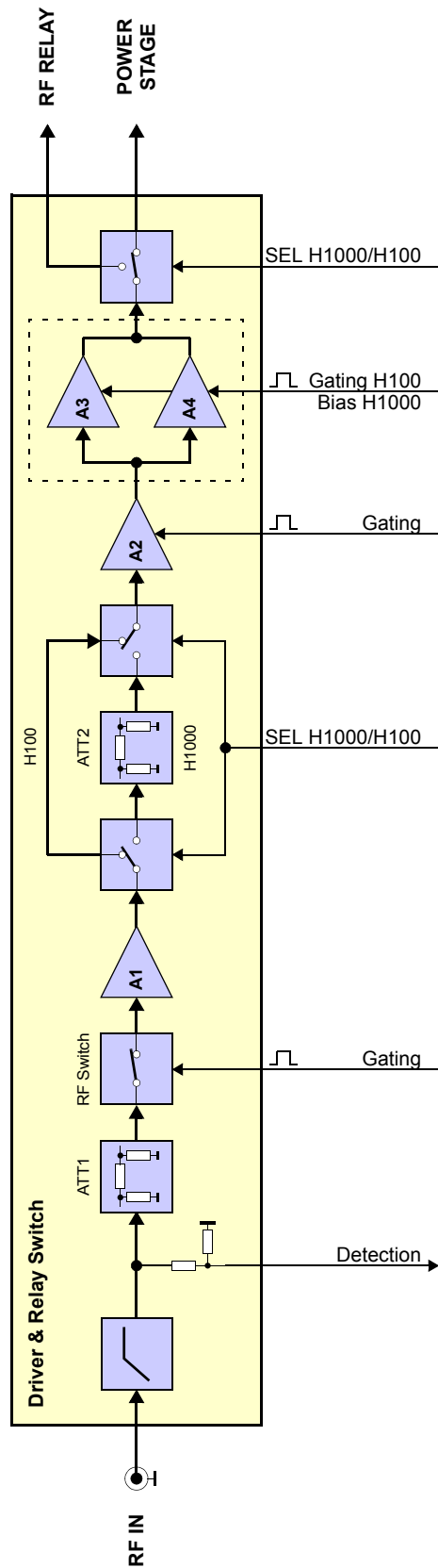

Figure 5.4. Driver & Relay Switch Block Diagram

The BLAH1000 E Amplifier 700-900MHz (P/N: W1345531) consists of a 3 input embedded router, a class A / AB driver amplifier, a class AB power amplifier, a bi-directional high dynamic coupler and a mechanical 2 output embedded router.

A nominal input power level of +4dBm produces a rated linear output power of :

- 100W peak for 25% duty cycle at 100ms pulse width maximum on the High Resolution channel 100W when selected. In this case, the 100W driver is directly switched to the high dynamic coupler and the output router via a pair of mechanical relays.
- 1000W peak for 5% duty cycle at 100ms pulse width maximum on the Solid channel 1000W when selected. In this case, the 100W driver is switched to the input of the 1000W power stage via a mechanical relay and a 2 ways power splitter.

The unit is also capable of longer pulses for lower average power, up to 50W CW power on the 1000W channel for Solid application and 25W CW power on the 100W channel for High Resolution application.

#### **Embedded Input Router**

The embedded router consists of a class A RF amplifier IC's and RF switches, manufactured on a Gallium Arsenide process.

It is built on a four independent cells architecture with three RF input cells and one output cell. The RF input cells ensure function of amplification and routing, the output cell ensures the functions of combining, RF amplitude thermo-stability and amplification.

The three RF inputs could be routed alone or combined each other to the RF output by selecting the wished RF path through the BLA controller board. Each entire RF path has a nominal 15dB of gain and operates at +15VDC.

Also, the router is equipped with an EEPROM for BIS information.

#### **RF Driver**

In the first section of the driver, the RF input signal is fed through a 5 poles high pass filter and the RF detection path. Then, via a thermal PAD attenuator and a GaAs RF switch, the RF signal is conveyed to a hybrid amplifier.

In this section, the GaAs RF switch requires a control board conditioned gating signal to control the operation of the switching element.

A commutable H1000/H100 attenuator follows the hybrid amplifier.

This attenuator is built of two GaAs RF switches, commutated by a control board conditioned signal SEL H1000/H100 and a thermo-compensated attenuator for compensation of the output power drift with temperature of the amplifier when the 1000W channel for Solid application is selected.

This commutable attenuator is needed to minimize gain of about 6dB when the amplifier is operating in Solid application and provides full gain in High Resolution application. It is divided in variable resistive attenuator to adjust output power and the Thermal PAD.

The second section of the driver includes a class AB LDMOSFET transistor followed by two cascaded class AB LDMOSFET transistors.

The polarization of these transistors require a control board conditioned gating signal to control the bias voltage on the gate of the FETs and depends of the selection H1000/H100 to prevent the increasing of anti-droop behaviour. If the 1000W channel is selected, the gating signal is unblanked else if the 100W channel is selected, it is blanked.



---

**Note :** The polarization of the Class AB LDMOSFET transistor used as driver is always blanked.

---

The circuitry around the transistors consists of complementary input and output transformers and baluns and operates the device in Push-Pull.

The RF driver has a nominal 32 to 34dB gain and operates at +32VDC.

With the embedded router gain, the entire path has a nominal 48dB gain in 100W mode for High Resolution operation and 42dB gain to drive the 1000W power amplifier stage for Solid operation.

### ***RF Relays H1000/H100 Selection***

The selection or not of the 1000W power amplifier is made by a pair of RF mechanical relays, one placed before the power amplifier and the other after.

In case of 100W operation, the pair of relays straps the power amplifier to deliver the 100W RF power directly to the bi-directional high dynamic coupler when the SEL H1000/H100 signal is controlled at TTL level high or not connected.

In case of 1000W operation, the pair of relays passes the RF power from the driver to the power amplifier when the SEL H1000/H100 signal is controlled at TTL level low, and feeds the power to the same bi-directional high dynamic coupler.

### ***RF Splitter***

The RF Splitter acts as a 2 ways in-phase splitter between the output of the RF driver and the inputs of the two power amplifiers.

### ***RF Power Amplifier***

Each power amplifier includes four class AB LDMOSFET transistors mounted on a single flange. They are coupled with -6dB four ways splitter/combiner to built a nominal 16dB gain and operates at +32VDC. The power amplifier requires a control board conditioned gating signal to control the bias voltage on the gate of the FETs.

The PA is followed by an isolator and an in-phase combiner.

### ***RF Combiner***

The RF Combiner acts as a 2 ways in-phase combiner between the outputs of the power amplifier and the mechanical relay and feeds the power to the input of the bi-directional high dynamic coupler.

### **RF Coupler**

The bi-directional high dynamic coupler provides an approximate coupling of 1V peak DC signal for full 1000W or 100W depending of the SEL H1000/H100 signal, and also a peak DC signal for the reflected power.

Both signals, forward and reflected, are analyzed by the BLA control board for monitoring and protection setting on the MAIN and AUX outputs.

### **Output Router**

The output router is made with a mechanical RF relay and is located between the high dynamic coupler and the both RF outputs. This relay achieve the RF power to once or other, MAIN OUT 1000W/100W or AUX OUT 1000W/100W in function of the software selection from Topspin. See "**Output Routing Block Diagram**" on page 22.

### **Isolators**

The RF isolator is a three-port passive device where one port is permanently connected to a load. It is made of magnets and ferrite material used to control the direction of signal flow in a circuit and protects the output power transistor from excessive signal reflection.

There is an isolator connected at the end of each RF board.

## **BLA Control Board**

## **5.2.2**

The BLA Control Board has 3 main functions:

1. Conditions the input blanking (BLNK) signal and delivers it to the above mentioned RF Paths.
2. Allows Ethernet communication with the workstation.
3. Monitor the output characteristics of the amplifier thanks to the DC peak detection of the bi-directional coupler.  
Electronic circuitry processes the detection information and protect the amplifier from overstress like :
  - Forward and reflected peak power

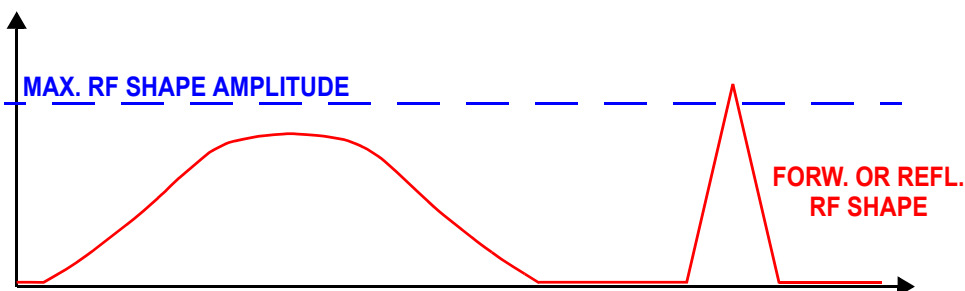

Figure 5.5. Peak Power Limitation

The peak power limitation is the maximum RF forward shape amplitude allowed at the amplifier output.

Limitation range : from 1% to 200% of nominal power.

The peak power limitation is checked for each sample (10 million samples per second), and the maximum peak value is latched then cleared by a read operation (for monitoring purpose).

- Forward pulse width

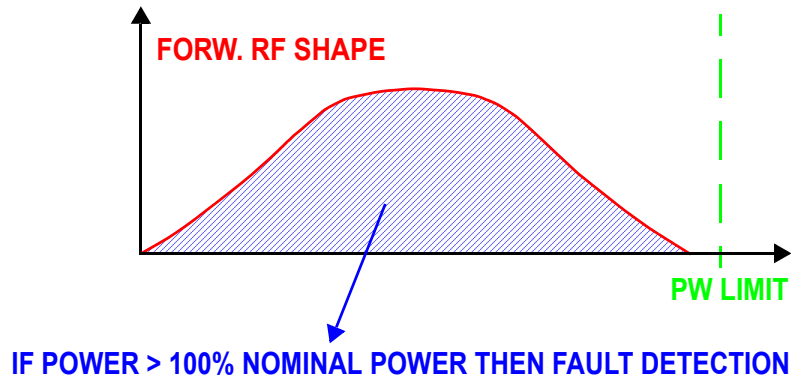

Figure 5.6. Forward Pulse Width Limitation

The pulse width is the lapse of time during which the nominal power can be applied.

Limitation range : from 0.1ms to 512ms.

The pulse width value is updated every 100 $\mu$ s.

- Forward pulse duty cycle

The duty cycle value is the ratio between measured input power during pulse width limitation value divided by duty cycle limitation value and the nominal power during the same time.

For example, if the pulse width limitation is set to 3ms and duty cycle is limited to 10%, then duty cycle value equals the measured input power during 30ms (3ms / 0.1) divided by the nominal power during 30ms.

Limitation range : from 1% to 100%.

The duty cycle value is updated every 100 $\mu$ s.

- Excess of reflected power (Mismatch)

The mismatch value is the ratio between the reflected power value and the forward power value.

Limitation range : from 1% to 100%.

The mismatch value is updated every 100 $\mu$ s.

- Other protections

The control board also detects the following faults :

- Power supply fault
- Fan failure
- Heat sink temperature to protect against thermal overstress
- Fault detection timings

Table 5.1. Fault Detection Timings

Fault	Detection delay (max)
Peak power	500 ns
Duty cycle	100 $\mu$ s
Pulse Width	100 $\mu$ s
Mismatch	100 $\mu$ s
Power Supply, Fan	200 ns
Heat sink temperature	500 ms

Peak, pulse width, duty cycle, mismatch and also mean power values can be read out at any time from the main DSP for monitoring purpose.

- Fault protection reset.

If one of these overstresses appears the board automatically resets the fault flags after 2 seconds, the gating signal is disabled and the status led board on the front panel displays the fault.

This means, for example, that when a pulse width fault occurs, the amplifier channel is disabled after the detection delay. The side effect is that the fault condition disappears since the channel's output power is null.

After 2 seconds, the channel is switched on and the cycle begins again (unless the channel RF input signal is re-adjusted to meet the power limitations).

### **BLA Extension Board**

**5.2.3**

This board gives the information to the control board of RF detection.

### **Status Led Board**

**5.2.4**

The status led board, on the front panel of the amplifier, displays overstress functions, supplies status, and so on, as described in **"Indicators" on page 13** and **"BLA Control Board" on page 28**.

### **BIS Board**

**5.2.5**

The universal BIS board is located on the amplifier case and contains identifications of the amplifier.

### ***Supply Status Board***

**5.2.6**

This board serves for monitoring the external power supplies and to signalize a default to the control board. In this case, the gating signal is disabled while the default is visualized on the front panel LED's display.



---

Technical help : [please contact your local representative.](#)

---





# *Servicing the BLA*

# 6

The BLAH1000 E Amplifier 700-900MHz provides diagnosis and servicing web pages relies on HTTP, allowing service access with any web browser.

## *Accessing the BLA Amplifier*

## **6.1**

The BLAH1000 E Amplifier 700-900MHz is accessible via the BLA control board with its IP address.

The IP address is given during "**cf**" by using TOPSPIN 2.5x or better software on the workstation.

In case of problems :

- Check the RJ45 cabling between amplifier, Ethernet switch and workstation.
- Check the Ethernet switch power.
- Check if the green LED on the amplifier RJ45 connector lights up.
- Check the front panel of the amplifier, LED's indicators +32V, +15V, -15V and +3.3V ON must have lit.

To access the BLAH1000 E Amplifier 700-900MHz, type "**ha**" in TOPSPIN 2.5x or better and choose the BLA that should be accessed or start your favourite web browser and type the given IP address as URL.

You should get the following start screen.

**think forward**

**Device Information**

Name: BLAH1000 E 700-900MHZ INR OTR  
 Part number: W1345531  
 Serial number: 0002  
 Ecl: 0  
 Manufacturing location: BFR  
 Manufacturing date: 7/8/09  
 BIS type: BLA

**Software Versions**

Boot version: 20051018  
 Kernel version: Windows CE 5.0  
 Application version: BLAC6\_20090311

**Channel Information**

Ch.	Type	Nom. power	Min freq.	Max freq.	Limits			Forw. peak	Output num.	Input num.
					Duty cycle	Pulse width	Mismatch			
1	H	1000 W	650 MHz	900 MHz	5 %	100 ms	500 W (50 %)	2000 W (200 %)	Via router	Via router

**High Resolution Option Information**

Ch.	Nom. power	Duty cycle	Pulse width	Limits		Output num.
				Mismatch	Forw. peak	
1	100 W	25 %	100 ms	50 W (50 %)	200 W (200 %)	Via router

© 2005-2008 Bruker Biospin SA. All rights reserved.

Figure 6.1. Device Information

This page gives you general information about the amplifier (default page).

In the main toolbar, we can see that a BLA is displayed.

The left panel is the navigation menu. It can be used to navigate through the service pages or choose another tab in the sub toolbar.

Leads you to a page giving information about the current status of the amplifier.

**Bruker Linear Amplifiers**

BLA

Information | Advanced Operations | Maintenance

**Amplifier status**

Name: BLAH1000 E 700-900MHZ INR OUTR  
 Part number: W1345531  
 Serial number: 0002  
 Ecl: 0

	Channel 1 (HR)
Type:	H
Nominal power:	100 W
Forward peak power:	0.00 %
Forward average power:	0.00 %
Reflected power:	0 %
Overdrive:	OK
Pulse width:	OK
Duty cycle:	OK
Mismatch:	OK
General gating fault:	OK
Supply:	OK
Thermal:	OK
Blanking signal state:	inactive
Input power:	none
Output power:	none
High resolution state:	active
Switchbox position:	0xFF

This page is automatically refreshed every 10 seconds

think forward

© 2005-2008 Bruker Biospin SA. All rights reserved.

Figure 6.2. Amplifier Status (High Resolution)

**Bruker Linear Amplifiers**

BLA

Information | Advanced Operations | Maintenance

**Amplifier status**

Name: BLAH1000 E 700-900MHZ INR OUTR  
 Part number: W1345531  
 Serial number: 0002  
 Ecl: 0

	Channel 1
Type:	H
Nominal power:	1000 W
Forward peak power:	0.00 %
Forward average power:	0.00 %
Reflected power:	0 %
Overdrive:	OK
Pulse width:	OK
Duty cycle:	OK
Mismatch:	OK
General gating fault:	OK
Supply:	OK
Thermal:	OK
Blanking signal state:	inactive
Input power:	none
Output power:	none
High resolution state:	inactive
Switchbox position:	0xFF

This page is automatically refreshed every 10 seconds

think forward

© 2005-2008 Bruker Biospin SA. All rights reserved.

Figure 6.3. Amplifier Status (Solid)

You should get the following start screen.

**think forward**

**Device Information**

Name: BLAH1000 E 700-900MHZ INR OTR  
 Part number: W1345531  
 Serial number: 0002  
 Ecl: 0  
 Manufacturing location: BFR  
 Manufacturing date: 7/8/09  
 BIS type: BLA

**Software Versions**

Boot version: 20051018  
 Kernel version: Windows CE 5.0  
 Application version: BLAC6\_20090311

**Channel Information**

Ch.	Type	Nom. power	Min freq.	Max freq.	Limits			Forw. peak	Output num.	Input num.
					Duty cycle	Pulse width	Mismatch			
1	H	1000 W	650 MHz	900 MHz	5 %	100 ms	500 W (50 %)	2000 W (200 %)	Via router	Via router

**High Resolution Option Information**

Ch.	Nom. power	Duty cycle	Pulse width	Limits		Output num.
				Mismatch	Forw. peak	
1	100 W	25 %	100 ms	50 W (50 %)	200 W (200 %)	Via router

© 2005-2008 Bruker Biospin SA. All rights reserved.

Figure 6.4. Device Information

This page gives you general information about the amplifier.

The left panel is the navigation menu. It can be used to navigate through the service pages or choose another tab in the sub toolbar.

Leads you to a page giving several default and current limits of the amplifier.

If you want, for any reasons, to change the current limits of the amplifier, press **Change limits**.

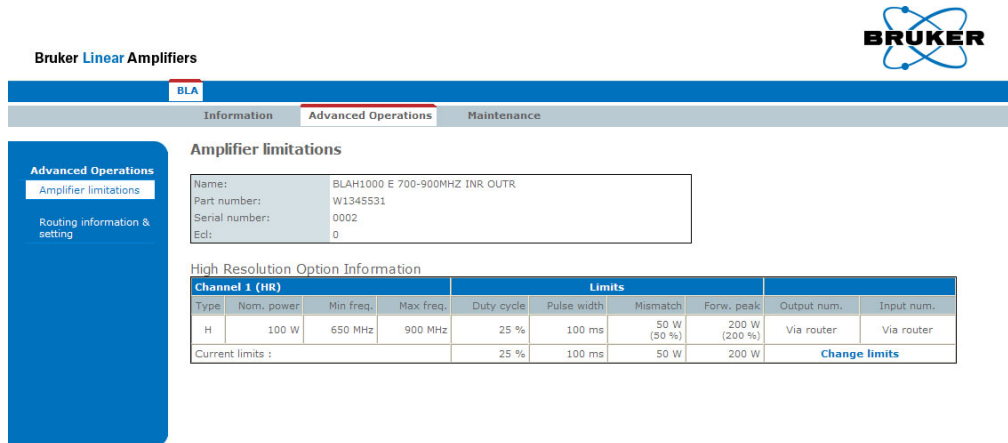

**Bruker Linear Amplifiers**

BLA

Information **Advanced Operations** Maintenance

**Amplifier limitations**

Name: BLAH1000 E 700-900MHZ INR OUTR  
 Part number: W1345531  
 Serial number: 0002  
 Ed: 0

High Resolution Option Information

Channel 1 (HR)				Limits				Output num.	Input num.
Type	Nom. power	Min freq.	Max freq.	Duty cycle	Pulse width	Mismatch	Forw. peak		
H	100 W	650 MHz	900 MHz	25 %	100 ms	50 W (50 %)	200 W (200 %)	Via router	Via router
Current limits :				25 %	100 ms	50 W	200 W	<a href="#">Change limits</a>	

think forward

© 2005-2008 Bruker Biospin SA. All rights reserved.

Figure 6.5. Amplifier Limitations (High Resolution)

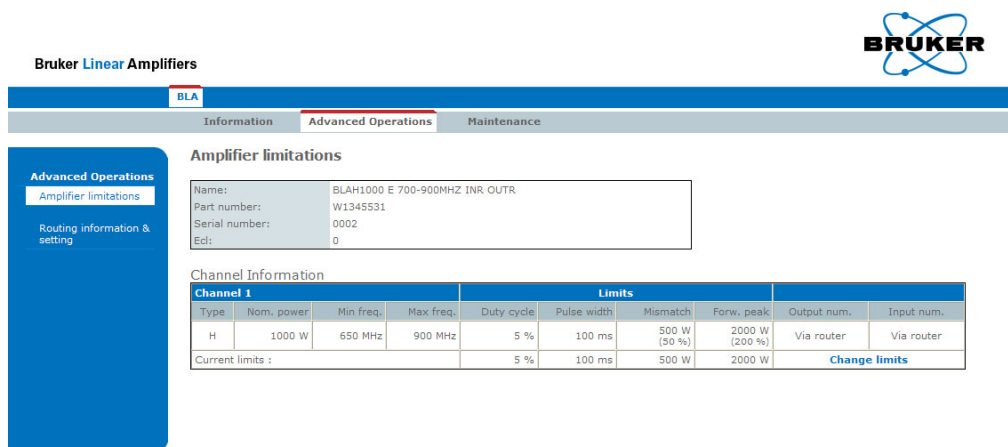

**Bruker Linear Amplifiers**

BLA

Information **Advanced Operations** Maintenance

**Amplifier limitations**

Name: BLAH1000 E 700-900MHZ INR OUTR  
 Part number: W1345531  
 Serial number: 0002  
 Ed: 0

Channel Information

Channel 1				Limits				Output num.	Input num.
Type	Nom. power	Min freq.	Max freq.	Duty cycle	Pulse width	Mismatch	Forw. peak		
H	1000 W	650 MHz	900 MHz	5 %	100 ms	500 W (50 %)	2000 W (200 %)	Via router	Via router
Current limits :				5 %	100 ms	500 W	2000 W	<a href="#">Change limits</a>	

think forward

© 2005-2008 Bruker Biospin SA. All rights reserved.

Figure 6.6. Amplifier Limitations (Solid)

Read the warnings, change limit parameters and press **Apply** if you are sure of that.



**Bruker Linear Amplifiers**

BLA

Information **Advanced Operations** Maintenance

**Advanced Operations**  
Amplifier limitations  
Routing information & setting

**Channel limitations**

Name: BLAH1000 E 700-900MHZ INR OUTR  
Part number: W1345531  
Serial number: 0002  
Ecl: 0

**High Resolution Option Limitations**

Changing these settings will overwrite the limitations defined with the spectrometer software. Please use this page for test purposes only.

Type :	H			
Nominal power :	100 W			
	Default	Current	New	Maximum
Duty cycle limit :	25 %	25 %	<input type="text" value="25"/> %	25 %
Pulse width limit :	100 ms	100 ms	<input type="text" value="100"/> ms	100 ms
Mismatch limit :	50 W (50 %)	50 W	<input type="text" value="50"/> W	100 W
Forward peak limit :	200 W (200 %)	200 W	<input type="text" value="200"/> W	200 W
	<input type="button" value="Apply"/>			
Output number :	Via router			
Input number :	Via router			

think forward

© 2005-2008 Bruker Biospin SA. All rights reserved.

Figure 6.7. Change Limits (High Resolution)



**Bruker Linear Amplifiers**

BLA

Information **Advanced Operations** Maintenance

**Advanced Operations**  
Amplifier limitations  
Routing information & setting

**Channel limitations**

Name: BLAH1000 E 700-900MHZ INR OUTR  
Part number: W1345531  
Serial number: 0002  
Ecl: 0

**Channel 1 limitations**

Changing these settings will overwrite the limitations defined with the spectrometer software. Please use this page for test purposes only.

Type :	H			
Nominal power :	1000 W			
Min. frequency :	650 MHz			
Max. frequency :	900 MHz			
	Default	Current	New	Maximum
Duty cycle limit :	5 %	5 %	<input type="text" value="5"/> %	5 %
Pulse width limit :	100 ms	100 ms	<input type="text" value="100"/> ms	100 ms
Mismatch limit :	500 W (50 %)	500 W	<input type="text" value="500"/> W	1000 W
Forward peak limit :	2000 W (200 %)	2000 W	<input type="text" value="2000"/> W	2000 W
	<input type="button" value="Apply"/>			
Output number :	Via router			
Input number :	Via router			

think forward

© 2005-2008 Bruker Biospin SA. All rights reserved.

Figure 6.8. Change Limits (Solid)

Leads you to a page giving information about the current routed RF path at the amplifier inputs.

Default RF paths are INPUT 1 to CHANNEL 1 and OUTPUT 1 to CHANNEL 1.

**Bruker Linear Amplifiers**

BLA

Information | **Advanced Operations** | Maintenance

**Routing Information & Setting**

Name: BLAH1000 E 700-900MHZ INR\_OUTR  
 Part number: W1345531  
 Serial number: 0002  
 Ed: 0

Changing these settings will overwrite the routes defined with the spectrometer software. Please use this page for test purposes only.

Input routing

Input number	Current channel	Possible channels	New route
1	1	1	Channel 1 <input type="button" value="set new route"/>
2	-	1	no route <input type="button" value="set new route"/>
3	-	1	no route <input type="button" value="set new route"/>

Output routing

Output number	Current channel	Possible channels	New route
1	1	1	Channel 1 <input type="button" value="set new route"/>
2	-	1	Channel 1 <input type="button" value="set new route"/>

think forward

© 2005-2008 Bruker Biospin SA. All rights reserved.

Figure 6.9. Routing Information and Setting

Read the warnings, it is allowed to change routing configuration of the input router and the output router (ex: new route INPUT 2 to CHANNEL 1 or new route OUTPUT 2 to CHANNEL 1), press **set new route** if you are sure of that.

You should get the following start screen.

The screenshot shows the Bruker Linear Amplifiers web interface. At the top right is the Bruker logo. Below it is a navigation bar with tabs for 'Information', 'Advanced Operations', and 'Maintenance'. The 'Maintenance' tab is selected. On the left is a blue sidebar with a 'Maintenance' menu containing 'Self test & Software reset', 'Firmware update', and 'BIS content'. The main content area is titled 'Device Information' and contains three sections: 'Device Information' (with fields for Name, Part number, Serial number, Ecl, Manufacturing location, Manufacturing date, and BIS type), 'Software Versions' (with fields for Boot version, Kernel version, and Application version), and 'Channel Information' (a table with columns for Ch., Type, Nom. power, Min freq., Max freq., Duty cycle, Pulse width, Mismatch, Forw. peak, Output num., and Input num.). Below the Channel Information table is a 'High Resolution Option Information' table with columns for Ch., Nom. power, Duty cycle, Pulse width, Mismatch, Forw. peak, and Output num. The text 'think forward' is visible on the left side of the screenshot.

**Device Information**

Name: BLAH1000 E 700-900MHZ INR OTR  
 Part number: W1345531  
 Serial number: 0002  
 Ecl: 0  
 Manufacturing location: BFR  
 Manufacturing date: 7/8/09  
 BIS type: BLA

**Software Versions**

Boot version: 20051018  
 Kernel version: Windows CE 5.0  
 Application version: BLAC6\_20090311

**Channel Information**

Ch.	Type	Nom. power	Min freq.	Max freq.	Limits					
					Duty cycle	Pulse width	Mismatch	Forw. peak	Output num.	Input num.
1	H	1000 W	650 MHz	900 MHz	5 %	100 ms	500 W (50 %)	2000 W (200 %)	Via router	Via router

**High Resolution Option Information**

Ch.	Nom. power	Duty cycle	Pulse width	Limits		
				Mismatch	Forw. peak	Output num.
1	100 W	25 %	100 ms	50 W (50 %)	200 W (200 %)	Via router

© 2005-2008 Bruker Biospin SA. All rights reserved.

Figure 6.10. Device Information

This page gives you general information about the amplifier.

The left panel is the navigation menu. It can be used to navigate through the service pages or choose another tab in the sub toolbar.



Leads you to a page allowing you to do a self-test on the BLA control board (Hardware test) and to do a software reset.

Both operations can be done if the amplifier doesn't work correctly.

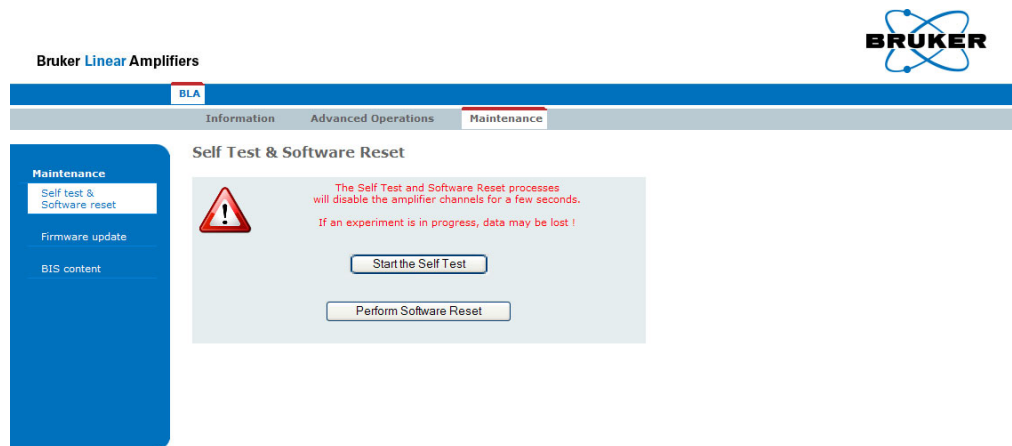

think forward

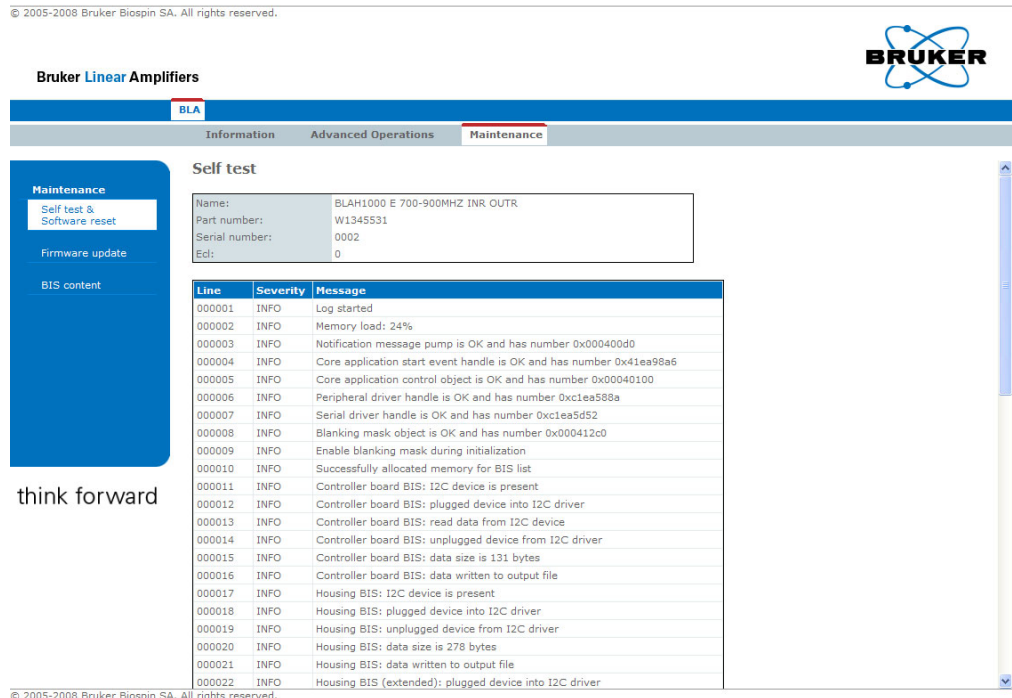

think forward

Figure 6.11. Perform Self Test and Report

Read the warnings, press **Start the Self Test**.

You should have only gray lines in the report.

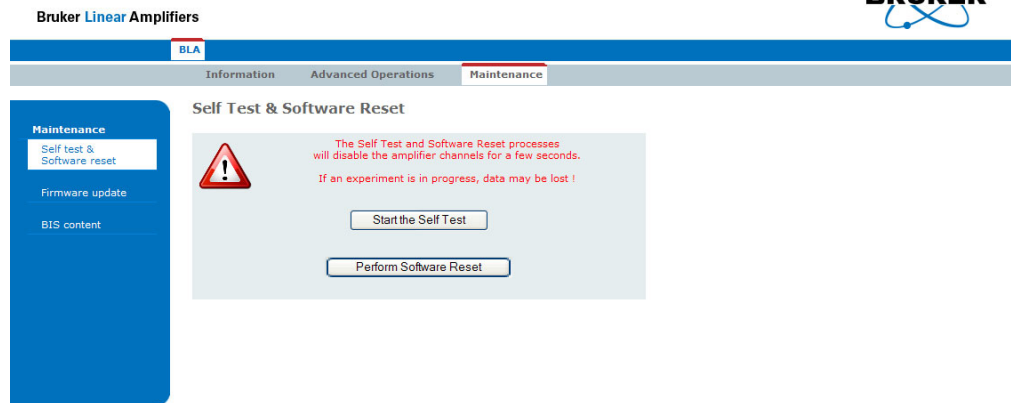

think forward

© 2005-2008 Bruker Biospin SA. All rights reserved.

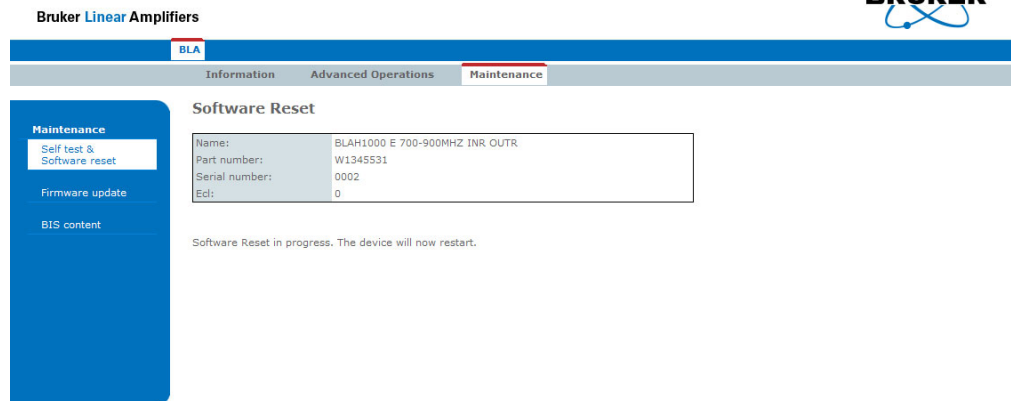

think forward

© 2005-2008 Bruker Biospin SA. All rights reserved.

Figure 6.12. Perform Software Reset and Report

Read the warnings, press **Perform Software Reset**.

You should have the following screen.

Leads you to a page allowing you to download new firmware.

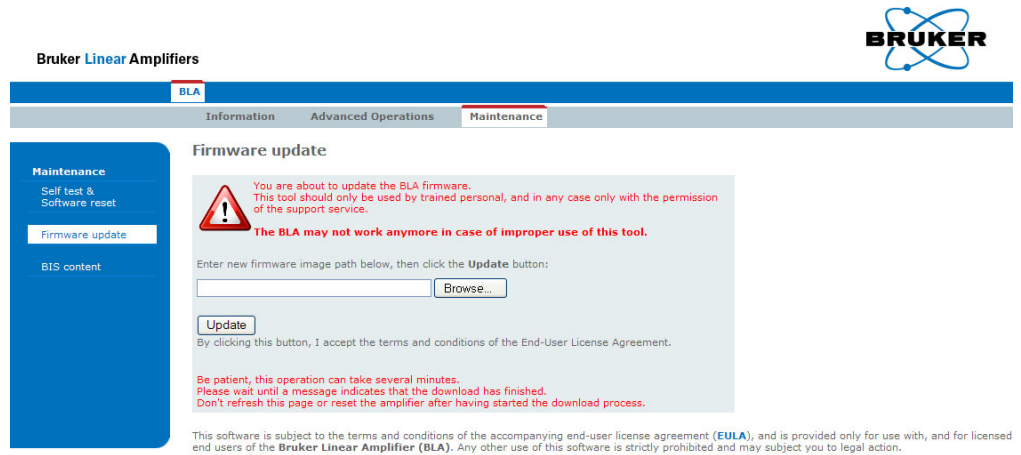

think forward

© 2005-2008 Bruker Biospin SA. All rights reserved.

Figure 6.13. Firmware Update

Read the warnings, press the **Browse** button for selecting the new firmware file to download and press **Update**. Download the new firmware will take a few minutes.



**NOTE :** This button caption depends on your operating system language settings.

Leads you to a page giving information about the current BIS programmed on the amplifier.



**Bruker Linear Amplifiers**

BLA

Information    Advanced Operations    Maintenance

**Maintenance**

- Self test & Software reset
- Firmware update
- BIS content**

**BIS Content**

BIS Id:	1
BIS description:	BLA Controller
BIS type:	BLAC
BIS content:	<pre> \$Bis,1,20090309,2048,BLAC,1# \$Prd,W1522050,00777,03,\$BDE,20090309# \$Nam,BLA CONTROL BOARD 6 2V H-USB# \$CtrlVers,1,0,6,0# \$EndBis,A5,2C#                     </pre>
BIS Id:	2
BIS description:	BLA Housing
BIS type:	BLA
BIS content:	<pre> \$Bis,1,20090708,2048,BLA,4# \$Prd,W134531,0002,0,\$BFR,20090708# \$Nam,BLAH1000 E 700-900MHZ INR OUTR# \$Amp,1,1,1,H,,1000,F8,5,100,650,900,0,0,50,200,200,# \$HROpt,1,0,1,,100,25,100,650,900,0,50,200,200# \$RtOutChar,1,0,650,900,0# \$RtOutPath,1,0,1,1,1# \$RtOutPath,1,0,2,1,0# \$EndBis,55, ae#                     </pre>
BIS Id:	3
BIS description:	Mini-Router
BIS type:	BLAROUTER
BIS content:	<pre> \$Bis,1,20090708,2048,BLAROUTER,1# \$Prd,W1345212,0857,0,\$BFR,20090708# \$Nam,BLMMR31 RF AMPLIFIER MODULE# \$RtInChar,1,0,10,1000,15# \$RtInPath,1,0,1,1,1# \$RtInPath,1,0,2,1,1# \$RtInPath,1,0,3,1,1# \$EndBis,15, 2a#                     </pre>

think forward

© 2005-2008 Bruker Biospin SA. All rights reserved.

Figure 6.14. BIS Content

# Specifications

# 7

## Common Characteristics

## 7.1

Table 7.1. Amplifier Common Characteristics

<b>Constant Internal Protection</b>	Supplies, fans faults and over temperature. Forward Power : peak & CW power, pulse width and duty cycle. Reflected Power : peak & CW power, self resetting protection shuts the amplifier off if the load VSWR is excessive.
<b>Front Panel Indicators</b>	Amplifier Status Led Board.
<b>Front Panel Interfaces</b>	1 x I/O 8 pins RJ45 connector.
<b>Front Panel Controls</b>	1 x SEL H1000/H100 control signal.
<b>Front Panel Connectors</b>	3 x RF input, 2 x RF output, 1 x blanking input (gating).
<b>Rear Panel Connectors</b>	15 pins DIN 41612-H ERNI female connector. (power supply connection).
<b>Cooling System</b>	Forced-air cooling (from front to rear).
<b>Size</b>	19" rack cabinet x 3U height x 520mm depth.
<b>Weight</b>	23kg
<b>Power Requirements</b>	Additional 208-230 VAC $\pm$ 10% single phase 50-60Hz switched power supply, Bruker Biospin part number W1304007. A front panel circuit breaker turns the AC Line ON/OFF. A status led board, on the front panel, indicates the power supplies condition. Size : 19" rack cabinet x 2U height x 480mm depth. Weight : 14kg.

## Specifications

### General Specifications

7.2

#### Channel High Resolution 100W Output

7.2.1

Table 7.2. Channel High Resolution 100W Output Specifications

<b>Frequency Range</b>	650 to 900MHz
<b>Linear Gain</b>	48dB $\pm$ 0.5dB typical
<b>Gain Flatness</b>	$\pm$ 1dB max.
<b>Minimum Pulsed Output Power</b> (@ nominal Input +4dBm)	100W min. full range
<b>CW Output Power</b> (Internal Limitation)	25W max.
<b>Linear Output Power</b>	85W typical @ 1dB compression
<b>Linearity</b>	$\pm$ 1dB to 85W typical
<b>Amplifier Biasing</b>	Class AB operation
<b>Blanking Delay Time</b>	1 $\mu$ s min.
<b>RF Rise Time</b>	< 100ns
<b>RF Fall Time</b>	< 50ns
<b>DC Ringing</b>	$\pm$ 100mV typical (due to blanking signal)
<b>Input Noise Figure</b>	8dB typical
<b>Output Noise Power</b> (Unblanked)	-117dBm @ 1Hz
<b>Output Noise Power</b> (Blanked)	Thermal Noise
<b>Input/Output Impedance</b>	50 $\Omega$
<b>Input V.S.W.R. Route OFF</b>	1.5 : 1 max.
<b>Input V.S.W.R. Route ON</b>	1.5 : 1 max.
<b>Output Harmonics</b> (2fc ; 3fc)	-50dBc ; -70dBc max. @ 100W
<b>Pulse Width</b> (Internal Limitation)	100ms @ 100W (up to CW @ 25W)
<b>Duty Cycle</b> (Internal Limitation)	25% @ 100W (up to 100% @ 25W)
<b>Droop &amp; Pulse Flatness</b>	$\pm$ 2% typical @ 100W for 100ms Pulse Width
<b>Amplitude Stability vs. Temperature</b>	$\pm$ 0.1% / $^{\circ}$ C max.

Table 7.3. Channel Solid 1000W Output Specifications

<b>Frequency Range</b>	650 to 900MHz
<b>Linear Gain</b>	58dB ±0.5dB typical
<b>Gain Flatness</b>	±2dB max.
<b>Minimum Pulsed Output Power</b> (@ nominal Input +4dBm)	1000W min. full range
<b>CW Output Power</b> (Internal Limitation)	50W max.
<b>Linear Output Power</b>	1000W typical @ 1dB compression
<b>Linearity</b>	+2dB / -1dB to 1000W typical
<b>Amplifier Biasing</b>	Class AB operation
<b>Blanking Delay Time</b>	1µs min.
<b>RF Rise Time</b>	< 100ns
<b>RF Fall Time</b>	< 50ns
<b>DC Ringing</b>	±100mV typical (due to blanking signal)
<b>Input Noise Figure</b>	8dB typical
<b>Output Noise Power</b> (Unblanked)	-105dBm @ 1Hz
<b>Output Noise Power</b> (Blanked)	Thermal Noise
<b>Input/Output Impedance</b>	50Ω
<b>Input V.S.W.R. Route OFF</b>	1.5 : 1 max.
<b>Input V.S.W.R. Route ON</b>	1.5 : 1 max.
<b>Output Harmonics</b> (2fc ; 3fc)	-45dBc ; -65dBc max. @ 1000W
<b>Pulse Width</b> (Internal Limitation)	100ms @ 1000W (up to CW @ 50W)
<b>Duty Cycle</b> (Internal Limitation)	5% @ 1000W (up to 100% @ 50W)
<b>Droop &amp; Pulse Flatness</b>	±3% typical @ 1000W for 100ms Pulse Width
<b>Amplitude Stability vs. Temperature</b>	±0.15% / °C max.





# Service Information and Maintenance

# 8

Every intervention on the device must be carried out by an authorized and qualified person. Any failure due to a non-respect of the following instructions will not be attributable to BRUKER BIOSPIN and will not be covered by the guarantee clauses.

## ***Preventive Maintenance of the RF Module on BLA-Type Amplifiers***

### **8.1**

The RF module inside BLA's Amplifiers is equipped with a easily extractible PUSH FAN Assembly.

Fan's on assembly have a high reliability and manufacturer gives a expected live time of 70000 hours (8 years) at 25°C and 5 years at 60°C.

Replacement of the assembly could be done in the field when a misfonction of fans is detected by lightning from the OVERHEAT Status Led.

To prevent such a misfonction, a preventive maintenance could be done every 4 years.

This assembly can be ordered on the manufactory BBIO-FR by P/N:

- **W1346523** «PUSH FAN ASSEMBLY 6».
- **W1346527** «PULL FAN ASSEMBLY 4».

## ***Operation***

### **8.1.1**

1. Disconnect all cables from the front panel and the supply connector on the rear panel. Remove the amplifier from the NMR console and place it on a secure flat surface.
2. Unscrew and remove the coverage plate from the amplifier.
3. Disconnect the 2 wires (red +32V / black GND) being on the RF module dispatch supply connectors and coming from the Push fan assembly as well as the 2 wires (red +32V / black GND) being on the dispatch supply connectors located on the bottom of the BLA housing and coming from the Pull fan assembly. Also disconnect the fan status wires (white) from BLA Control board connector J18 and J21.

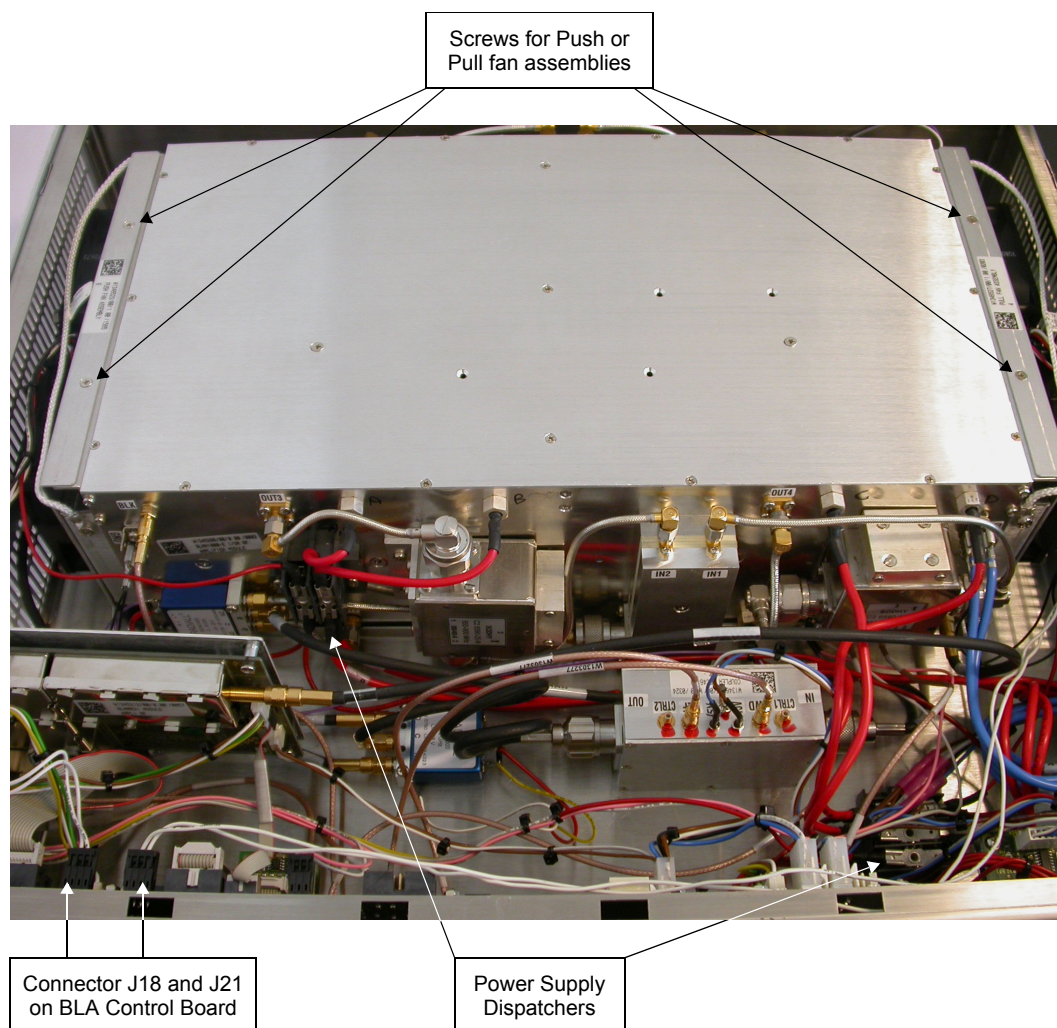

Figure 8.1. Push Fan Assembly

4. Unscrew the 2 screws on the top of the Push and Pull fan assembly on both side of the RF module.
5. Remove the Push and Pull fan assembly.
6. Place correctly the 2 new fan assemblies in the bottom holes of the RF module and screw it on the top.
7. Connect all wires (status and supplies).
8. Connect supply cable from amplifier to external power supply and turn on the amplifier. Note that the fans are turning and no OVERHEAT status led appears on front panel.
9. Put the coverage plate on the amplifier and screw it.
10. Put the amplifier in the NMR console, connect all cables on the front panel and the supply connector on the rear panel of the external power supply.

# Figures

- 1 General Information** **5**
  
- 2 Safety** **7**
  - Figure 2.1. Identifying Plate ..... 7
  - Figure 2.2. Manufacturer’s Name Plate ..... 8
  
- 3 Installation** **9**
  
- 4 Operation** **13**
  - Figure 4.1. BLAH1000 E Amplifier 700-900MHz Front Panel Design ..... 15
  - Figure 4.2. BLAH1000 E Amplifier 700-900MHz Front Panel View ..... 15
  - Figure 4.3. DIN 41612-ERNI Connector Design ..... 16
  - Figure 4.4. BLAH1000 E Amplifier 700-900MHz Rear Panel Design ..... 17
  - Figure 4.5. BLAH1000 E Amplifier 700-900MHz Rear Panel View ..... 17
  - Figure 4.6. Power Supply Front Panel Design ..... 18
  - Figure 4.7. Power Supply Front Panel View ..... 19
  - Figure 4.8. Power Supply Rear Panel Design ..... 19
  - Figure 4.9. Power Supply Rear Panel View ..... 19
  
- 5 Technical Description** **21**
  - Figure 5.1. Output Routing Block Diagram ..... 22
  - Figure 5.2. BLAH1000 E Amplifier 700-900MHz System Block Diagram ..... 23
  - Figure 5.3. Embedded Router Block Diagram ..... 24
  - Figure 5.4. Driver & Relay Switch Block Diagram ..... 25
  - Figure 5.5. Peak Power Limitation ..... 28
  - Figure 5.6. Forward Pulse Width Limitation ..... 29
  
- 6 Servicing the BLA** **33**
  - Figure 6.1. Device Information ..... 34
  - Figure 6.2. Amplifier Status (High Resolution) ..... 35
  - Figure 6.3. Amplifier Status (Solid) ..... 35
  - Figure 6.4. Device Information ..... 36
  - Figure 6.5. Amplifier Limitations (High Resolution) ..... 37
  - Figure 6.6. Amplifier Limitations (Solid) ..... 37
  - Figure 6.7. Change Limits (High Resolution) ..... 38
  - Figure 6.8. Change Limits (Solid) ..... 38
  - Figure 6.9. Routing Information and Setting ..... 39
  - Figure 6.10. Device Information ..... 40
  - Figure 6.11. Perform Self Test and Report ..... 41
  - Figure 6.12. Perform Software Reset and Report ..... 42
  - Figure 6.13. Firmware Update ..... 43
  - Figure 6.14. BIS Content ..... 44

<b>7 Specifications</b>	<b>45</b>
<b>8 Service Information and Maintenance</b>	<b>49</b>
Figure 8.1. Push Fan Assembly .....	50

# Tables

<b>1 General Information</b>	<b>5</b>
<b>2 Safety</b>	<b>7</b>
<b>3 Installation</b>	<b>9</b>
<b>4 Operation</b>	<b>13</b>
Table 4.1. Indicators Assignment .....	13
Table 4.2. Coaxial Connectors Assignment .....	14
Table 4.3. RJ45 Pin Assignment .....	14
Table 4.4. DIN 41612-ERNI Pin Assignment .....	16
Table 4.5. Power Supply Indicators Assignment .....	18
<b>5 Technical Description</b>	<b>21</b>
Table 5.1. Fault Detection Timings .....	30
<b>6 Servicing the BLA</b>	<b>33</b>
<b>7 Specifications</b>	<b>45</b>
Table 7.1. Amplifier Common Characteristics .....	45
Table 7.2. Channel High Resolution 100W Output Specifications .....	46
Table 7.3. Channel Solid 1000W Output Specifications .....	47
<b>8 Service Information and Maintenance</b>	<b>49</b>





**End of Document**

# Bruker BioSpin, your solution partner

Bruker BioSpin provides a world class, market-leading range of analysis solutions for your life and materials science needs.

● **Bruker BioSpin Group**

[info@bruker-biospin.com](mailto:info@bruker-biospin.com)  
[www.bruker-biospin.com](http://www.bruker-biospin.com)

