

BMPC II

- Bruker Magnet Pump Control 2
Technical Manual
Version 006



Copyright© by Bruker Corporation

All rights reserved. No part of this publication may be reproduced, stored in a retrieval system, or transmitted, in any form, or by any means without the prior consent of the publisher. Product names used are trademarks or registered trademarks of their respective holders.

This manual was written by

Uwe Döttling and Reinhard Steppe

© June 8, 2015: Bruker Corporation

Rheinstetten, Germany

P/N: Z31823

DWG-Nr.: Z4D10373E

For further technical assistance on the BMPC II unit, please do not hesitate to contact your nearest BRUKER dealer or contact us directly at:

BRUKER Corporation
am Silberstreifen
D-76287 Rheinstetten
Germany

Phone:+ 49 721 5161 0
FAX:+ 49 721 5171 01
E-mail:nmr-support@bruker.de
Internet:www.bruker.com

1	About	7
1.1	This Manual	7
1.2	Policy Statement	7
1.3	Symbols and Conventions.....	7
2	Introduction.....	9
2.1	Modes of Operation.....	9
2.2	User Interface	9
2.3	Parameter and System Configuration Overview	9
2.4	Alarm and Notification System	10
2.5	Additional Information Available in This Manual.....	10
3	Safety.....	11
3.1	General.....	11
3.2	Intended Use	11
3.3	Safe Handling of Cryogenic Substances.....	12
3.4	Analog Telecommunication Safety.....	13
4	Technical Data	15
4.1	Dimensions and Voltage Supply Requirements	15
4.2	Site Conditions	15
4.3	Noise Level.....	16
4.4	Power Input Safety Fuse	16
5	Hardware Overview	17
5.1	System Block Diagram	17
5.2	The BMPC/2 Magnet Pump Control.....	19
5.2.1	TFT Display	19
5.2.2	BMPC/2 Control Unit	20
5.2.3	Industrial PC.....	20
5.2.4	Internal UPS	21
5.2.5	Pump Cabinet.....	21
5.2.6	BMPC/2 Line Control Unit	23
5.3	BMPC/2 Wiring Box.....	25
5.4	CAN Bus.....	26
5.4.1	CAN Bus Structure	26
5.5	Wiring Overview	27
5.6	Electrical Connections Overview.....	28
5.6.1	BMPC/2 Control Unit	28
5.6.2	Industrial PC.....	28
5.6.3	Internal UPS (for Industrial PC, PC Monitor).....	29
5.6.4	External UPS	29
5.6.5	Line Control Unit.....	30

6	Transport, Packaging and Storage	35
6.1	Symbols on the Packaging	35
6.2	Inspection at Delivery	37
6.3	Packaging.....	38
6.4	Storage	38
7	Principles of Operation	39
7.1	Manual Mode.....	39
7.1.1	Mode Buttons	39
7.1.2	Pump 1 and Valve 1 Buttons.....	40
7.1.3	Pump 2 and Valve 2 Buttons.....	40
7.1.4	Valve 3 Buttons	40
7.2	Pumps and Valves in Manual Mode.....	40
7.3	Automatic Pump Mode	42
7.3.1	The Default Pump.....	42
7.4	Monitoring and Pump Control in Automatic Pump Mode.....	43
7.4.1	P1 Pressure Monitoring.....	43
7.4.2	T1/T2 Temperature Monitoring.....	44
7.4.3	FI Helium Flow Monitoring.....	44
8	Software	45
8.1	Starting the BMPC/2 Software.....	45
8.2	Program Overview	46
8.3	Display Modes.....	48
8.3.1	Process Display.....	48
8.3.2	Graphical Display	49
8.3.3	Jumbo Display	53
8.3.4	Data Log Display	55
8.3.5	Present Values/Event Display	56
8.4	Operation Modes	57
8.4.1	OFF Mode	57
8.4.2	Monitor Only Mode	57
8.4.3	Monitor & Alarm Mode.....	58
8.4.4	He Fill Mode	59
8.5	Automatic Pump Test	60
8.5.1	Description of the Test Cycle.....	60
8.5.2	Configuring the Automatic Pump Test.....	61
8.5.3	Manual Start of the Pump Test.....	62
9	Alarm System.....	65
9.1	Alarm System Function	65
9.2	Alarm Configuration.....	66
9.3	Alarm Sequence	66
9.4	Alarm Groups	67

9.4.1	Internal Group	67
9.4.2	External Group	67
9.4.3	Fax Group	67
9.4.4	E-mail Group	67
9.5	Stopping the Alarm Sequence.....	67
10	Voice Box System	69
10.1	Alarm Call from the BMPC/2	69
10.2	Remote Status Request	70
10.2.1	Voice Box Menu	70
10.2.2	Fax Menu	70
10.2.3	E-Mail Menu	71
10.2.4	Using the Voice Box	72
11	Setup and Diagnostics Tool	73
11.1	Starting the Setup Tool.....	73
11.2	Downloading New Firmware	74
11.3	Run CAN Bus Diagnostic	75
11.4	Calibrate Temperature Linearization Function	76
12	Configuration (Administrator)	77
12.1	Magnet Setup Wizard.....	77
12.2	Customer Setup Wizard	79
12.2.1	Phone Line & Modem Setting.....	79
12.2.2	Contact List	80
12.2.3	Alarm Groups	81
12.2.4	Fax Setup - Fax ID	82
12.2.5	Fax Setup - Fax Header (System).....	83
12.2.6	Fax Setup - Fax Header (Customer)	84
12.2.7	Customer Setup - Fax Setup - Fax Header (Bruker).....	85
12.2.8	Customer Setup - Summary.....	86
12.3	The Options Menu.....	87
12.3.1	Options - General	87
12.3.2	Pump Control	90
12.3.3	Monitoring System.....	94
12.3.4	Alarm & Phone System	102
12.3.5	Service	112
13	Maintenance and Cleaning	113
13.1	Maintenance Work	113
13.1.1	Exchanging the Internal UPS Battery.....	113
13.2	Cleaning	113

14	Troubleshooting	115
14.1	Information Window Messages	115
14.1.1	Description of Error Messages	116
14.2	Messages in the Event Log	123
14.2.1	Additional Error Messages in the Event Log	123
14.3	Error Message at the Start of BMPC/2 Control Program.....	124
14.3.1	Database Update Error.....	124
14.3.2	Version Check Error	125
14.4	Other Errors.....	125
14.4.1	When the Value of a Parameter is Displayed as NAN	125
14.5	Pump Replacement on Bath-Cooled Systems	126
14.6	Pump Replacement on Systems with Helium Recovery	128
14.7	The NMR Console Switches Off Too Fast.....	131
14.7.1	Adjusting the NMR Console Turn-off Time.....	131
14.8	Turning on the NMR Console After a Power Failure	132
14.8.1	Restarting the NMR Console Through the Software	132
14.8.2	Restarting the NMR Console Using the Mains Switch	133
14.9	Exchanging Fuses	133
14.9.1	Exchanging the Pump Cabinet Ventilator Fuse.....	133
14.9.2	Exchanging the GS1 or GS2 Power Supply Fuses	135
14.9.3	Exchanging the Control Unit Fuse.....	135
15	Dismantling and Disposal.....	137
16	Contact	139
Appendix A	141
A.1	Warning Signs	141
A.2	Figures.....	143
A.3	Tables.....	145
A.4	Glossary	147
A.5	Index.....	149

1 About

1.1 This Manual

This manual is intended to be a reference guide for operators and service technicians. It provides detailed information about the user level maintenance and service and overall use of the Bruker device.

This manual is an integral part of the device, and must be kept in close proximity to the device where it is permanently accessible to personnel. In addition, instructions concerning labor protection laws, operator regulations tools and supplies must be available and adhered to.

The figures shown in this manual are designed to be general and informative and may not represent the specific Bruker model, component or software/firmware version you are working with. Options and accessories may or may not be illustrated in each figure.

Carefully read all relevant chapters before working on the device!

This manual describes parts and procedures relevant to the device version it is delivered with. For older hardware, please refer to the manual supplied at the time.

1.2 Policy Statement

It is the policy of Bruker to improve products as new techniques and components become available. Bruker reserves the right to change specifications at any time.

Every effort has been made to avoid errors in text and figure presentation in this publication. In order to produce useful and appropriate documentation, we welcome your comments on this publication. Support engineers are advised to regularly check with Bruker for updated information.

Bruker is committed to providing customers with inventive, high quality products and services that are environmentally sound.

1.3 Symbols and Conventions

Safety instructions in this manual are marked with symbols. The safety instructions are introduced using indicative words which express the extent of the hazard.

In order to avoid accidents, personal injury or damage to property, always observe safety instructions and proceed with care.



! DANGER

This combination of symbol and signal word indicates an immediately hazardous situation which could result in death or serious injury unless avoided.



⚠ WARNING

This combination of symbol and signal word indicates a potentially hazardous situation which could result in death or serious injury unless avoided.



⚠ CAUTION

This combination of symbol and signal word indicates a possibly hazardous situation which could result in minor or slight injury unless avoided.

NOTICE

This combination of symbol and signal word indicates a possibly hazardous situation which could result in damage to property or the environment unless avoided.

-
- i** This symbol highlights useful tips and recommendations as well as information designed to ensure efficient and smooth operation.
-

2 Introduction

The Bruker Magnet Pump Control 2 (BMPC/2, Bruker part number H13035) is a Windows XP based system that supervises and serves the pumps and valves that are needed for the stable operation of sub-cooled Bruker ultra high field magnets.

The main functions include:

- Monitoring of the magnet status and the most important cryogenic system parameters.
- Monitoring and control of the pump system.
- Alarm system.

2.1 Modes of Operation

The BMPC/2 can be operated in two different modes, manual or automatic. The modes of operation are discussed in detail in the chapter ["Principles of Operation" on page 39](#).

2.2 User Interface

The BMPC/2 is controlled by a **software user interface**. This interface contains three user levels:

1. **User** - Standard User Level
2. **Administrator** - System Administration and Configuration Level
3. **Service** - For Bruker Service Personnel

There are five different screen display modes and four different work display modes available within the user interface. These various software interface displays can be configured individually by the System Administrator or by Bruker Service. Refer to the chapter ["Software" on page 45](#) for an overview of the user interface.

2.3 Parameter and System Configuration Overview

The BMPC/2 system is pre-configured by Bruker service personnel during installation.

The configuration parameters for the alarm and voice box systems can be adjusted by the System Administrator or by Bruker Service. Information for the Administrator on how to configure the system is available in the chapter ["Configuration \(Administrator\)" on page 77](#).

2.4 Alarm and Notification System

An integral part of the BMPC/2 system is the Alarm System and Voice Box System.

The **Alarm System** is needed for the supervision of the magnet system. A description of this system is available in the chapter "[Alarm System](#)" on page 65.

The **Voice Box System** is the telephone interface that is used for an alarm sequence or for requesting a remote status report. An overview of this system is available in the chapter "[Voice Box System](#)" on page 69.

2.5 Additional Information Available in This Manual

The following chapters have been included in this manual to provide additional information for the user:

- "[Hardware Overview](#)" on page 17
- "[Maintenance and Cleaning](#)" on page 113
- "[Setup and Diagnostics Tool](#)" on page 73
- "[Troubleshooting](#)" on page 115
- "[Technical Data](#)" on page 15
- "[Contact](#)" on page 139

3 Safety

3.1 General

The following safety guidelines are relevant for the Bruker Magnet Pump Control 2 (BMPC/2) unit:

- Service and maintenance should only be accomplished by qualified personnel.
- Only personnel trained on the use of the BMPC/2 should operate the unit.
- Read this manual completely before operating the BMPC/2. Pay particular attention to any warning references made.

NOTICE

To avoid switching off the device by accident the BMPC/2 circuit breaker is not directly accessible for the user. The circuit breaker of the UPS unit can be used to switch off the BMPC/2 unit.

Disconnect the mains power supply before servicing the unit.

NOTICE

Small quantities of liquid helium are present in the Joule-Thomson refrigeration unit inside the magnet to which the BMPC is connected. In some non-standard operational scenarios, this liquid volume can evaporate rapidly, and lead to a slight increase of the pressure in the pump inlet. The pump inlet is protected by a bursting disc installed in the pump line between the BMPC and the magnet. This bursting disc limits the maximum overpressure to 2 bar.

3.2 Intended Use

The device has been designed and constructed solely for the intended use described here.

Intended use also includes compliance with all specifications within this manual.

Any use which exceeds or differs from the intended use and the instructions of this manual shall be considered improper use and may impair the safety of operation. No claims of any kind for damage will be entertained if such claims result from improper use.

The BMPC/2 is intended for sub-cooling and controlling of Bruker ultra high field magnets. It is not intended for other purposes or for sub-cooling of non-approved magnets. Users must follow all instructions in this manual and observe all local or regional rules and regulations.

If you have questions about how to use the BMPC/2, please contact the supplier.

NOTICE

Please keep this manual for future use.

3.3 Safe Handling of Cryogenic Substances

NOTICE

The BMPC pumps gaseous helium at room temperature from the magnet, and expels the helium gas into the atmosphere or into a helium recovery system. The maximum flow rate is on the order of 3 SLPM. Helium is a noble gas. It is nontoxic and inflammable. In case of a leak, or if the BMPC is not connected to a helium recovery system, the helium concentration in the vicinity of the BMPC can increase. To avoid this, the BMPC must only be operated in well ventilated areas. No gases other than helium are released from the BMPC.

WARNING



Cryogenic Substances

To avoid injury, cryogenic substances must be handled and stored in a safe manner.

- ▶ Refer to the magnet manual for information on the safe handling and storage of cryogenic substances.

3.4 Analog Telecommunication Safety

NOTICE

Analog Telecommunication Safety Warnings

Before servicing, disconnect this product from its power source and telephone network, and adhere to the following safety warnings:

- ▶ Never install telephone wiring during a lightning storm.
- ▶ Never install a telephone jack in wet locations unless the jack is specifically designed for wet locations.
- ▶ Use this product with UL and cUL listed computers only.
- ▶ Never touch uninsulated telephone wires or terminals unless the telephone line has been disconnected at the network interface.
- ▶ Use caution when installing or modifying telephone lines.
- ▶ Avoid using a telephone during an electrical storm. There may be a remote risk of electrical shock from lightning.
- ▶ Do not use a telephone in the vicinity of a gas leak.
- ▶ **CAUTION:** To reduce the risk of fire, use only 26 AWG or larger UL listed or CSA certified telecommunication line cord.

For USA and Canada a modem cable must be used with the following properties:

- 2 x RJ11 - 6P4C - 26AWG - AWM 20251

4 Technical Data

4.1 Dimensions and Voltage Supply Requirements

Data	Value	Unit
Weight	260	kg
Weight without monitor and monitor arm	250	kg
Length	118	cm
Width	70	cm
Height (monitor position adjustable)	ca. 174	cm
Height without monitor and monitor arm	130	cm

Table 4.1: General Information

Data	Value	Unit
Voltage	208 -230	V AC
Apparent current consumption, maximum	30	A
Circuit protection	40	A
Frequency	50 - 60	Hz

Table 4.2: Electrical Connection Values

4.2 Site Conditions

The BMPC/2 should only be used:

- In a standard laboratory environment.
- Up to a maximum elevation of 2000 meters.
- At a temperature between 15-35 °C.
- A relative humidity of a maximum of 80% for temperatures up to 31°C, linearly decreasing to 67% at a temperature of 35 °C.

To allow for adequate ventilation the unit must be sited at least 30 cm from any wall.

4.3 Noise Level

The measured noise level for the single-rack BMPC/2 is less than 65 dBA. The measured noise level for the high-throughput double-rack BMPC/2 is below 60 dBA.

4.4 Power Input Safety Fuse

The power input safety fuse for the BMPC/2 is a 40A dual-element time delay fuse Class J 600V. The Bruker part number for this fuse is **87159**. Two fuses of this type are used in the unit.

5 Hardware Overview

5.1 System Block Diagram

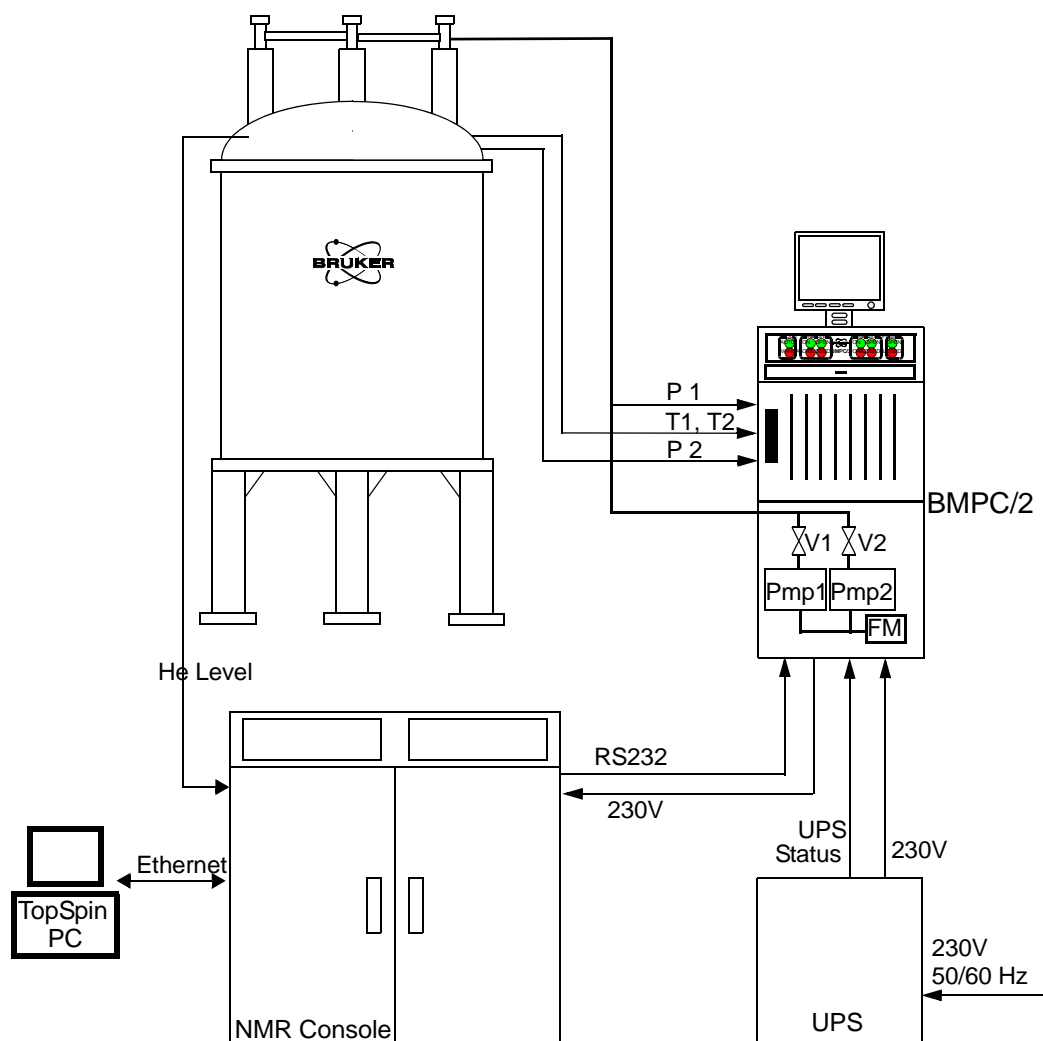

Figure 5.1: System Block Diagram for Non-refrigerated Bath Cooled Aeon NMR Systems

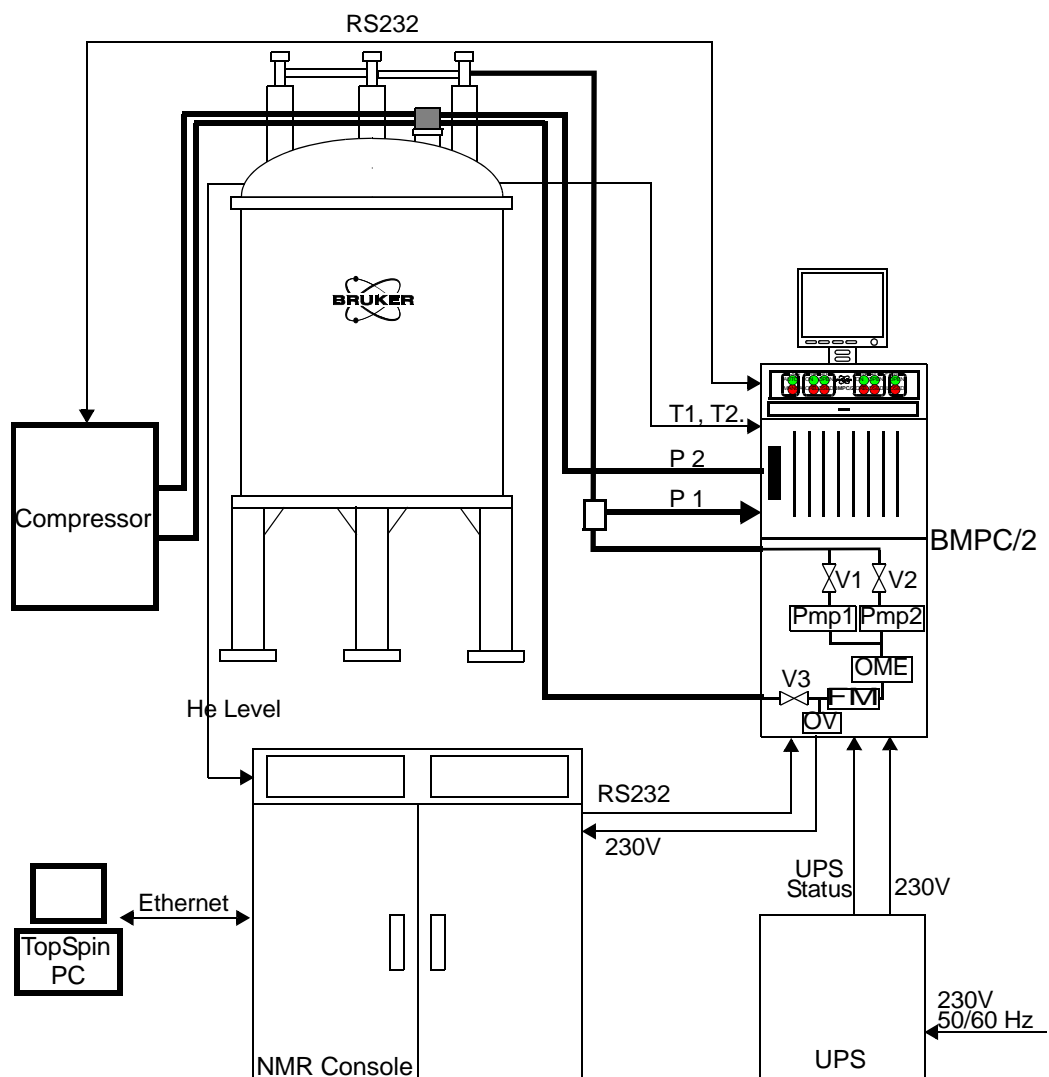

Figure 5.2: System Block Diagram Magnet Systems with Helium Recovery

5.2 The BMPC/2 Magnet Pump Control

The BMPC/2 Magnet Pump Control Unit (P/N H13031) is equipped with:

- A "TFT Display"
- The "BMPC/2 Control Unit".
- The "Industrial PC".
- An additional "Internal UPS" (Uninterruptable Power Supply).
- A "Pump Cabinet" (both vacuum pumps, their according valves, flow meter).
- The "BMPC/2 Line Control Unit".

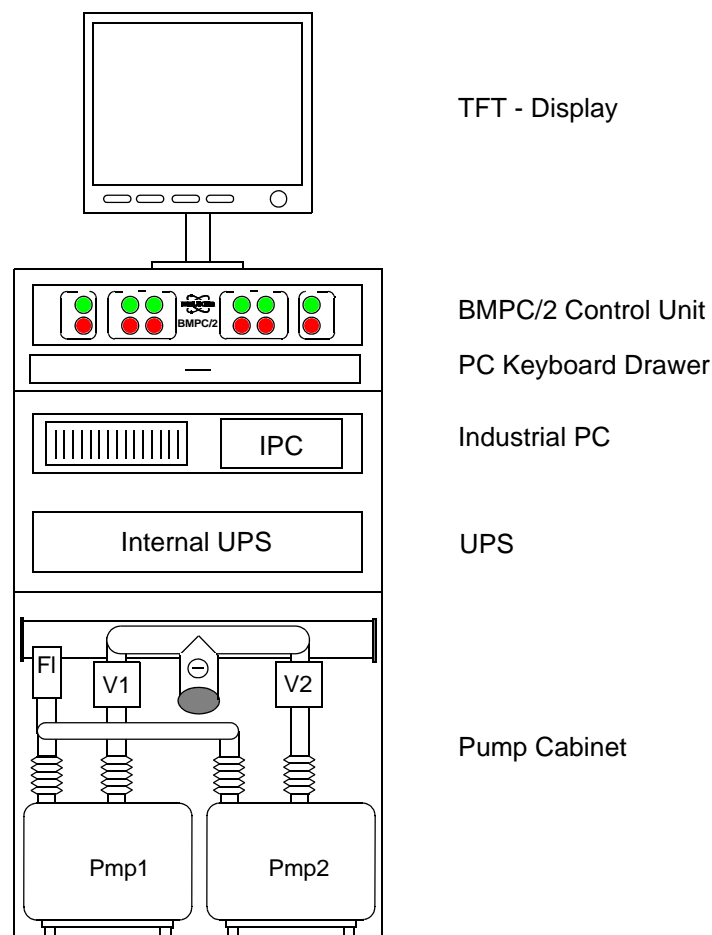

Figure 5.3: General Structure of the BMPC/2 Magnet Pump Control for Non-refrigerated Systems

5.2.1 TFT Display

The system utilizes a standard 19" TFT display with a resolution of 1280 x 1024 pixels. The display also includes a 2 port USB hub for use with accessories.

5.2.2 BMPC/2 Control Unit

The BMPC/2 Control Unit (P/N H13029) consists of the following main components:

Component	Description
BMPC/2 Manual Control Board	This board (P/N H13024) is used for manual control of the pumps and valves.
BMPC/2 Automatic Control Board	This Board (P/N H13022) is used to fulfill the following functions: <ul style="list-style-type: none"> • CAN bus master. • Output controller for pumps and valves. • Interface to the industrial PC (RS232). • Temperature measurement inside pump cabinet.
Power Supply	Power Supply Cosel LEB 100F (P/N 85348) 5V5A 24V 4A The power supply is used to supply the BMPC/2 control unit and the wiring box.
Absolute Pressure Device	The Absolute Pressure Device (APD) (P/N 87488) is used to control the pressure P2 in the helium tank of the magnet. It is controlled via the CAN bus.

Table 5.1 BMPC/2 Control Unit Components

5.2.3 Industrial PC

Industrial PC (IPC) with Windows XP meeting at least the following minimum requirements:

- Pentium M 2 GHz
- 512MB Ram
- 40GB Hard Disk
- DVD ROM
- 2 serial Ports (RS232)
- 19" rack mount 2HE
- Analog Voice Fax Modem (PCI)

5.2.4 Internal UPS

Uninterruptable Power Supply (ECL < 01.00: P/N O10440; ECL ≥ 01.00: P/N 1802515)

- Input: 208V, 200V*, 208V**, 220V, 230V (default), 240V

*100V and 200V are derated by 20%

**110V and 208V are derated by 10%

Voltage range at 100%: 180-276 Vac.

- 1000VA
- Bridging time: 7 minutes at full output load (1000VA)
- 19" rack mount 2HE

For more details refer to the separate UPS manual.

5.2.5 Pump Cabinet

The pump cabinet consists of:

- 2 vacuum pumps (Pmp1 and Pmp2) and 2 valves (V1 and V2), connected to the pumping line.
- A helium flow meter (FM) which measures the helium flow at the exhaust of both pumps. The flow meter (P/N 87487) is connected to the BMPC/2 control unit via the CAN bus.
- A temperature sensor (PT100) to measure the temperature T5 inside the pump cabinet.
- For Aeon systems (only), a valve 3 (V3) which opens and closes the connection between the outlet of the pumps and the return line to the cryostat. If V3 is closed, the pumped helium is relieved through the overflow valve (OV).

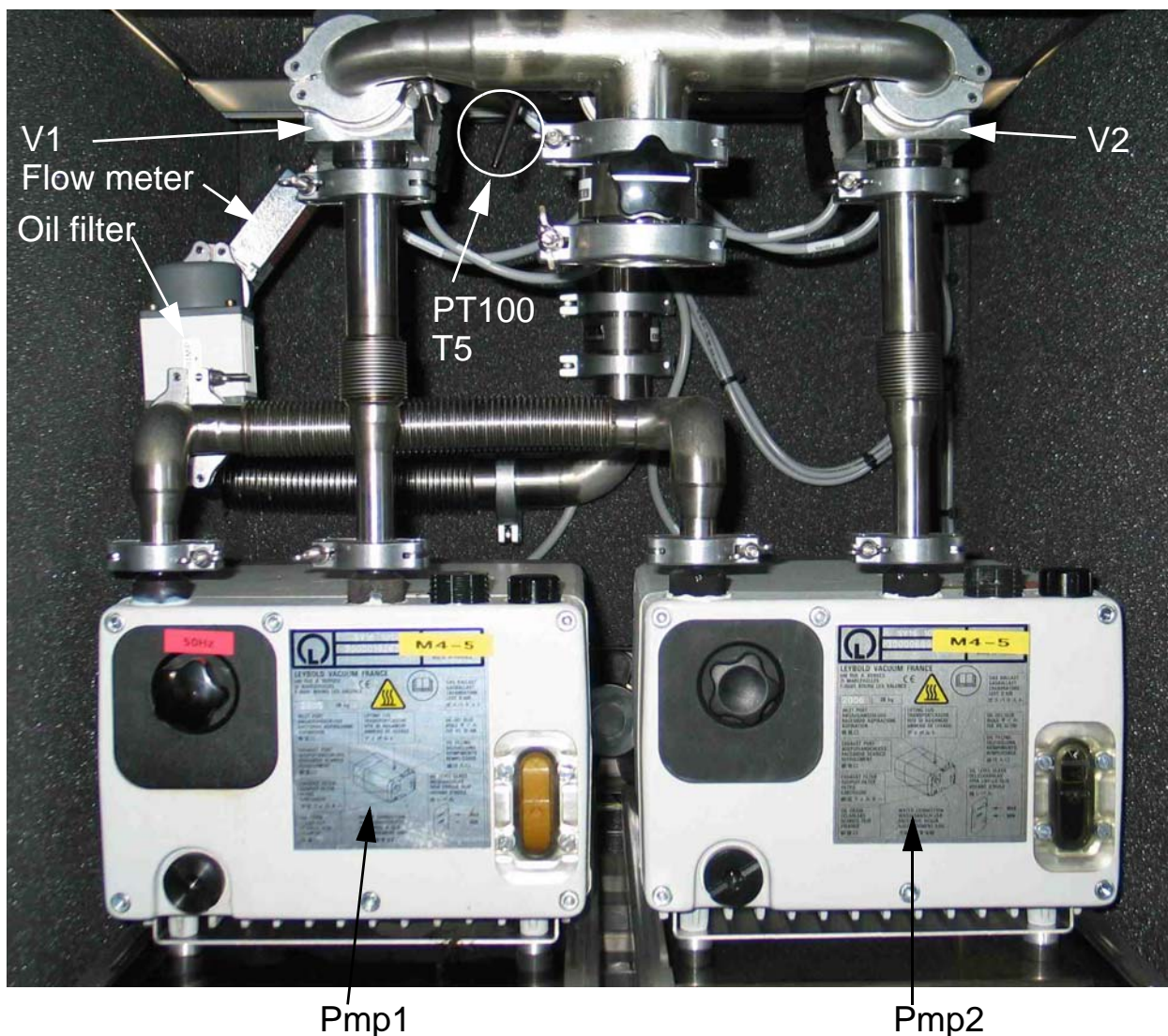

Figure 5.4: Interior of the Pump Cabinet

In the figure above valve V3 and the overflow valve OV, which are used for Aeon systems, are not shown. When installed, these two components are accommodated close to the real wall of the pump cabinet.

5.2.6 BMPC/2 Line Control Unit

The BMPC/2 Line Control Unit is used as an interface between the BMPC/2 control unit, the vacuum pumps and their corresponding valves. All fuses, motor protection switches, conductors and relays needed for the function of the BMPC/2 are part of this unit.

The line control unit is located in the upper rear part of the BMPC/2. To access the line control unit, you have to open the upper rear door using a screwdriver to turn both screws (quarter turn to the left). The door can then be easily removed.

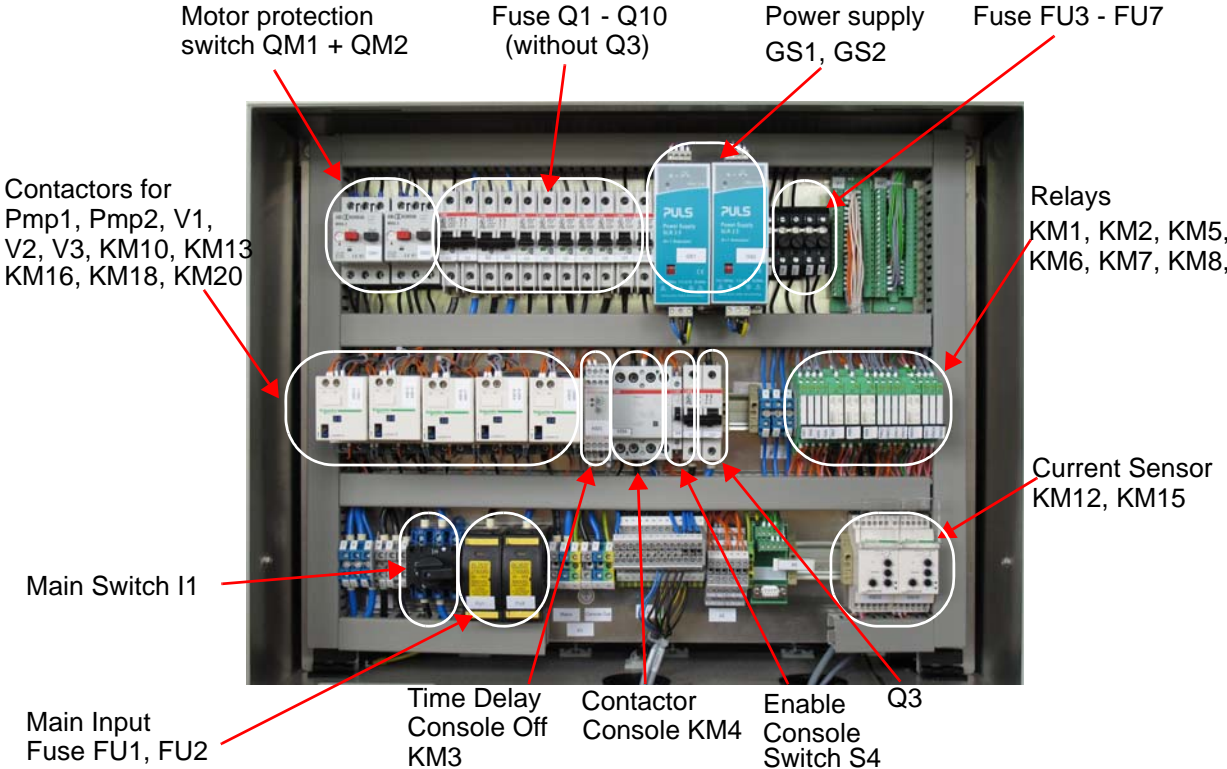

Figure 5.5: BMPC/2 Line Control Unit

Fuse	Purpose of Fuse	Value
Q1	Main fuse for: Power Supply GS 1/2, Pump 1/2, Valve 1/2/3, Warning Lamp, Industrial PC, Control Unit, Fan 1/2/3 (Ventilator 1/2/3)	16A / 277VAC
Q2	Cryo Platform Out (X4:26)	6A / 277VAC
Q3	Console Out (X3:4)	30A / 240VAC (ECL00: 32)
Q4	Valve 1 (X4:17)	6A / 277VAC
Q5	Valve 2 (X4:18)	6A / 277VAC
Q6	Valve 3 (X4:19)	6A / 277VAC
Q7	Warning Lamp (X4:20)	4A / 277VAC
Q8	Cryo-PSU (X4:27)	16A / 277VAC
Q9	Industrial PC/Monitoring System (X4:21)	4A / 277VAC
Q10	Control Unit (X4:22)	6A / 277VAC
FU1, 2	Main Fuses - Main Input	40A / 600VAC P/N: 87159
FU3	Power Supply - GS1	0.8A/T / 250VAC BRUKER P/N: 2250
FU4	Power Supply - GS2	0.8A/T / 250VAC BRUKER P/N: 2250
FU5	Fan 1 (Ventilator 1)	0.1A/T / 250VAC BRUKER P/N: 2241
FU6	Fan 2 (Ventilator 2)	0.1A/T / 250VAC BRUKER P/N: 2241
FU7	Fan 3 (Ventilator 3)	0.1A/T / 250VAC BRUKER P/N: 2241

Table 5.2 Fuse Overview

5.3 BMPC/2 Wiring Box

The BMPC/2 Wiring Box (P/N H13030) is mounted on a flange in the upper region of the magnet. It is designed as a CAN BUS slave and connects the BMPC/2 to the temperature sensors T1 and T2 and to the heater resistors for H1 and H2. The wiring box also contains a small LC display where the main magnet parameters and system messages can be viewed.



Figure 5.6: BMPC/2 Wiring Box

5.4 CAN Bus

A Controller Area Network (CAN) bus is an industrial standard bus used to establish communication between all the sensors, the BMPC/2 wiring box, and the BMPC/2.

5.4.1 CAN Bus Structure

The BMPC/2 control unit is designed as a CAN bus master. This means all communication on the bus is controlled and monitored from this master.

All sensors and the BMPC/2 wiring box are designed as CAN bus slaves. The BMPC/2 wiring box is also able to fulfill CAN bus master functions in case the BMPC/2 control unit is not functioning.

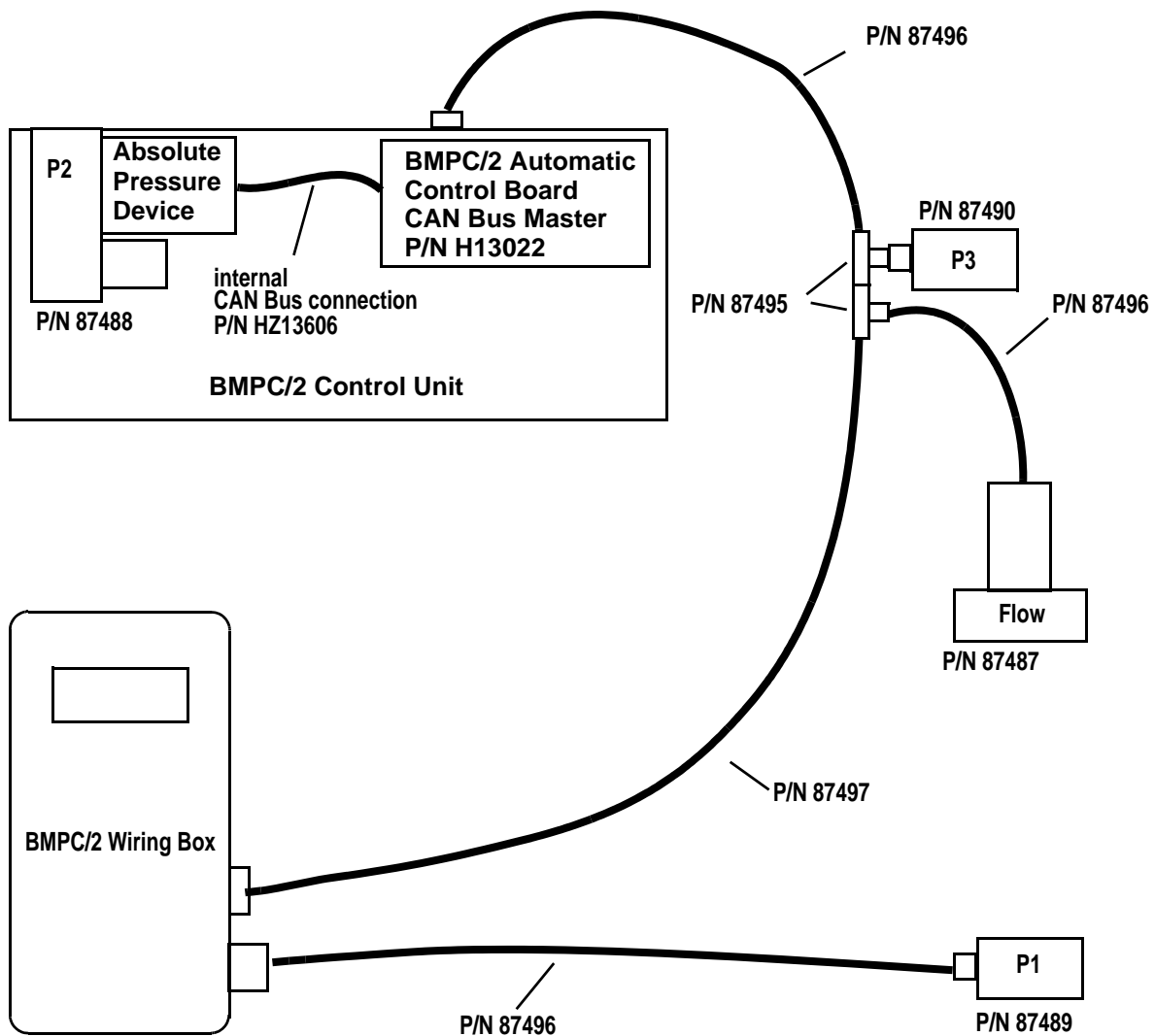

Figure 5.7: CAN Bus Structure

5.5 Wiring Overview

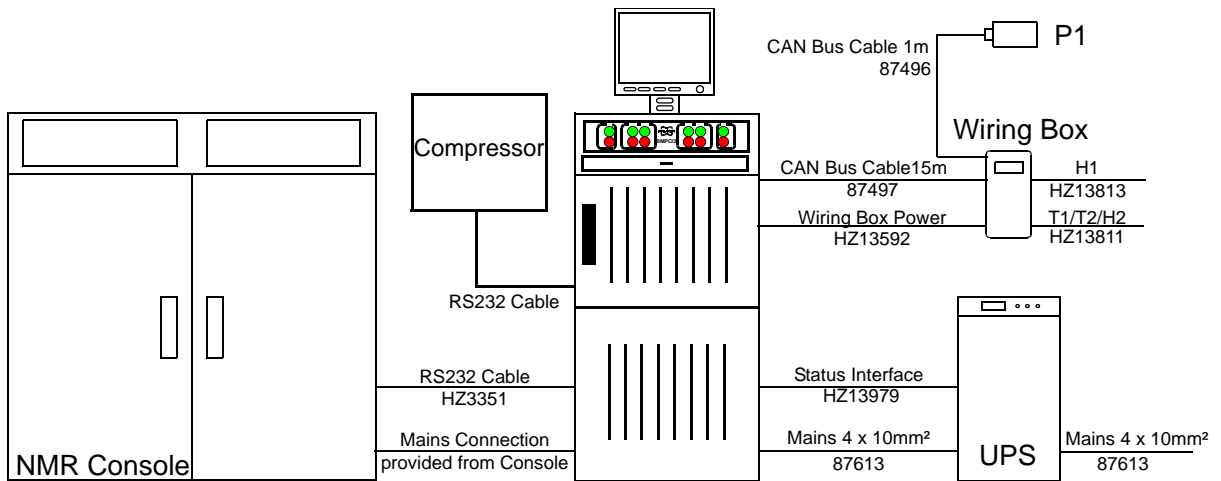

Figure 5.8: External Wiring Overview for use with NMR Spectrometers

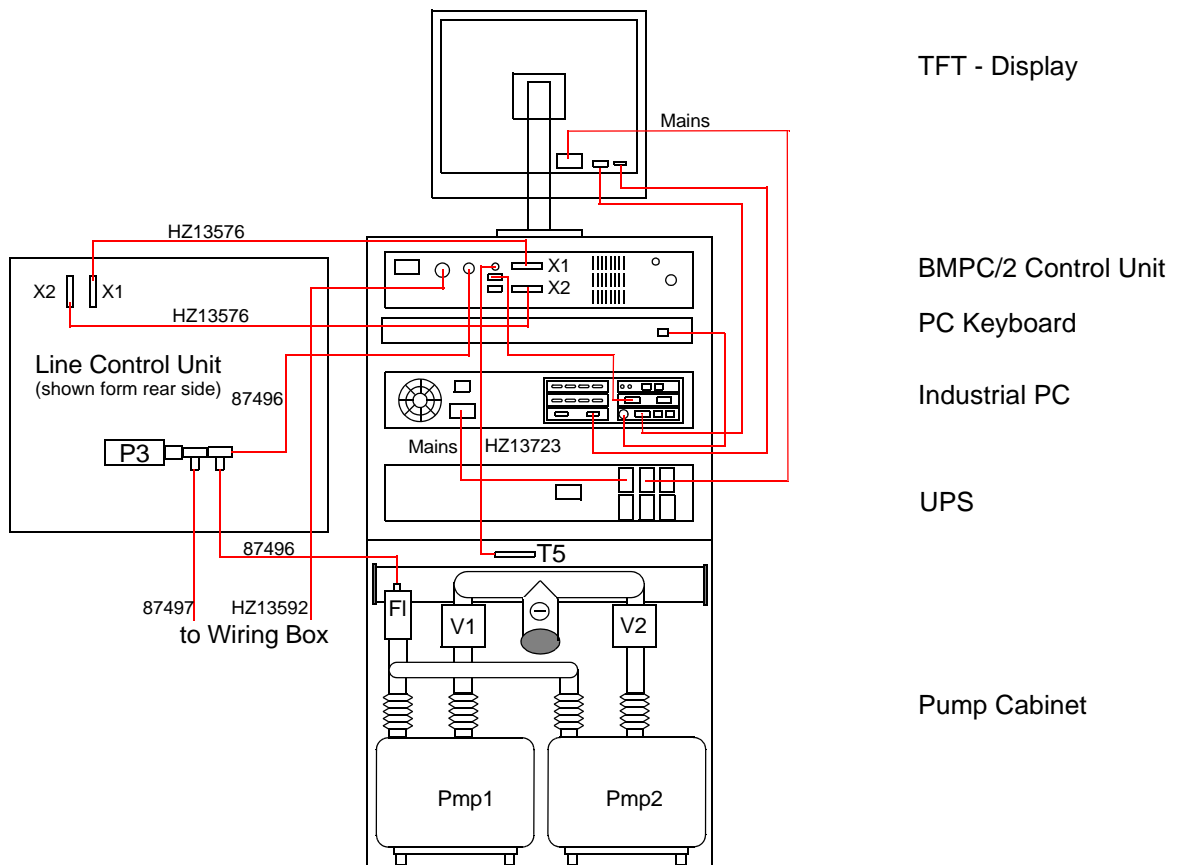

Figure 5.9: Internal Wiring Overview

5.6 Electrical Connections Overview

5.6.1 BMPC/2 Control Unit

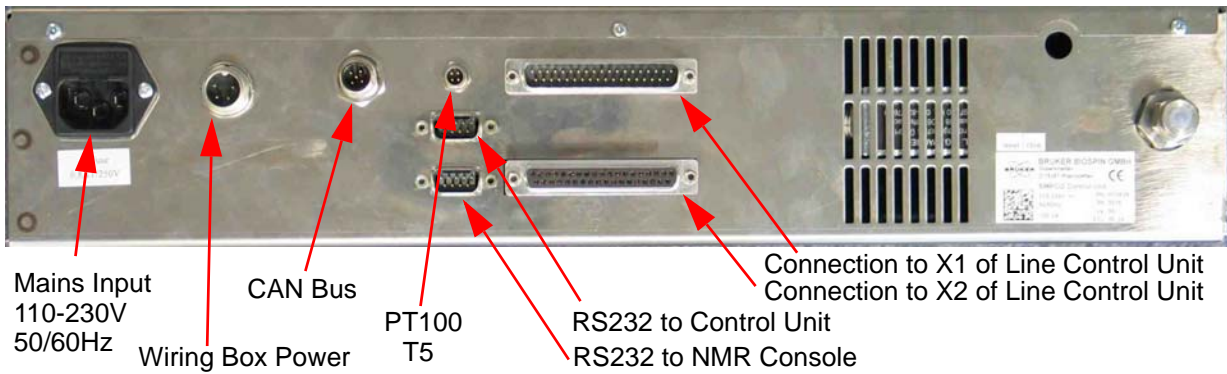

Figure 5.10: BMPC/2 Control Unit Rear Panel

5.6.2 Industrial PC

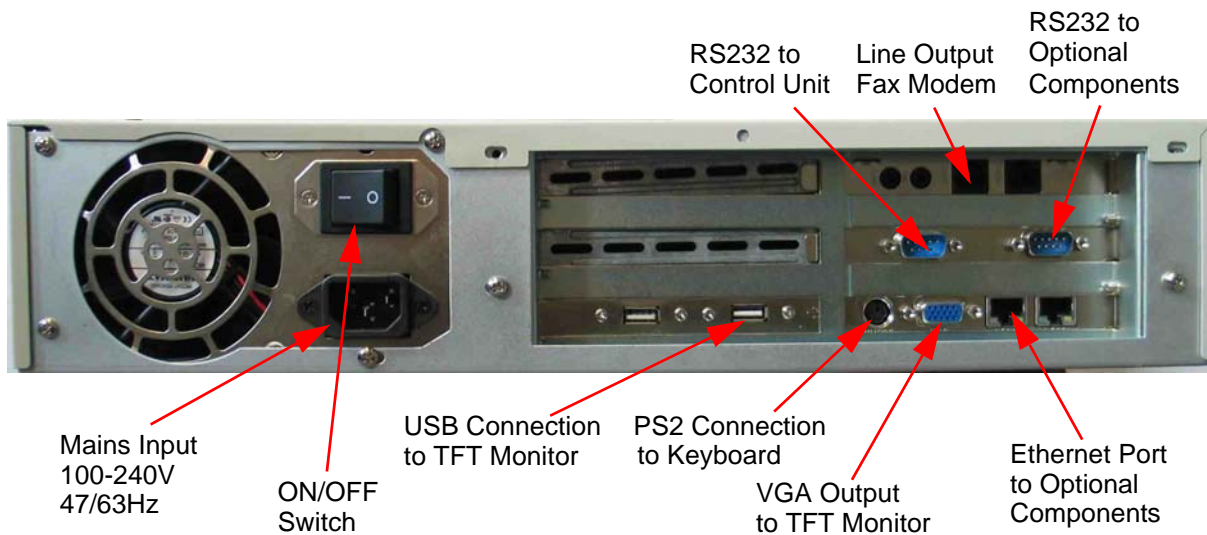

Figure 5.11: Industrial PC Rear Panel

5.6.3 Internal UPS (for Industrial PC, PC Monitor)

The internal 1kVA 19" Rack Mount UPS is used to protect the Industrial PC against downtime, data loss and helps to send alarm faxes and alarm calls in the case of a power failure for a time of 15-30 minutes.

Bruker P/N 1802515 - POWERWARE PW9130G-1000R-XL2UEU (UL listed)

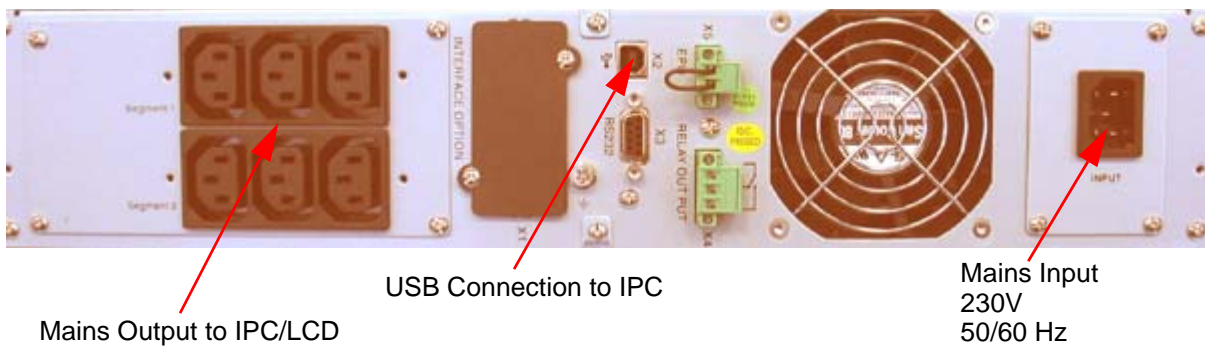

Figure 5.12: UPS - Uninterruptible Power Supply (P/N 1802515)

5.6.4 External UPS

The BMPC/2 is connected to an external UPS.

For Europe and other 50Hz regions:

- Bruker P/N 320751 - UPS GE Industrial LP 11 Series CE, 8 KVA 50 Hz

For USA, Canada and other 60 Hz regions:

- Bruker P/N 321928 - UPS GE Industrial LP 11U Series, 8 KVA, UL listed.

For USA/Canada the UPS is set up with an input/output voltage of 208 V with an output over current protection (AMPS) of 40 A.

For more details see the installation/user manual for the UPS and the Bruker Magnet Manual.

To switch off the BMPC/2 use the circuit breaker for the UPS:

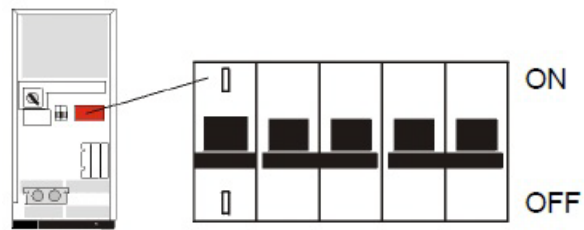

Figure 5.13: The UPS Circuit Breaker

5.6.5 Line Control Unit

5.6.5.1 Connectors to External Devices/Units

CAUTION



Equipment damage due to improper wiring.

The use of improper wiring for the mains input may lead to equipment damage or personal injury.

- ▶ Always use the cable OELFLEX-191 (P/N 87613) that is suitable for a temperature environment of at least 90°C.

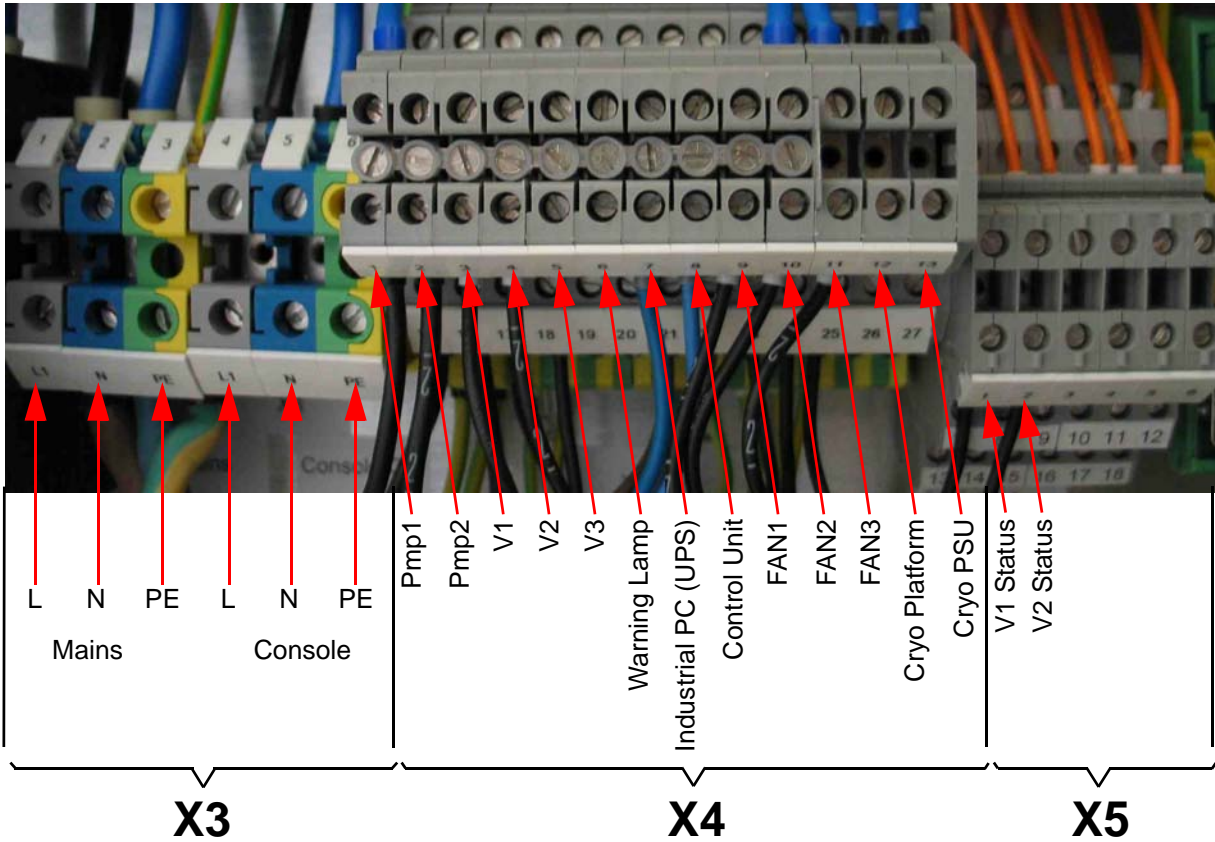

Figure 5.14: Line Control Unit Connector X3 / X4 / X5

Connector X4	Neutral	Line	PE	Connection Values
Mains Input	2	1	3	230 V 50/60 Hz
Console Output	5	4	6	230 V 50 Hz 4 kW

Table 5.3 Pin Count Connector X4

Connector X4	Neutral	Line	PE	Connection Values
Cryo Platform Output	26	12	40	230 V 50 Hz 1.38 kW
Warning Lamp	6	20	34	230 V 50 Hz 920 W
Cryo PSU	13	27	41	230V 50 Hz 3.6 kW

Table 5.4 Pin Count Connector X4

Connector X5	Relay Contacts	Connection Values
Pulse Tube Cooler Remote	6/12	6 A 230 V AC
Alarm 1	4/10	6 A 230 V AC
Alarm 2	5/11	6 A 230 V AC

Table 5.5 Pin Count Connector X5

Output	Neutral	Line	PE
Pmp1	1	15	29
Pmp2	2	16	30
V1	3	17	31
V2	4	18	32
V3	5	19	33
Warning Lamp	6	20	34
Industrial PC	7	21	35
Control Unit	8	22	36
FAN 1	9	23	37
FAN2	10	24	38
FAN 3	11	25	39
Cryo Platform	12	26	40
Cryo PSU	13	27	41

Table 5.6 Pin Count Connector X4

Pin No.	Function	Pin No.	Function	Pin No.	Function
1	Valve1 Pin b	7	NC	13	Valve1 Pin d
2	Valve2 Pin b	8	NC	14	Valve2 Pin d
3	NC	9	NC	15	NC
4	NC	10	NC	16	NC
5	NC	11	NC	17	NC
6	NC	12	NC	18	NC

Table 5.7 Pin Count Connector X5

NC = Not Connected

5.6.5.2 Connector X6 UPS Status Interface

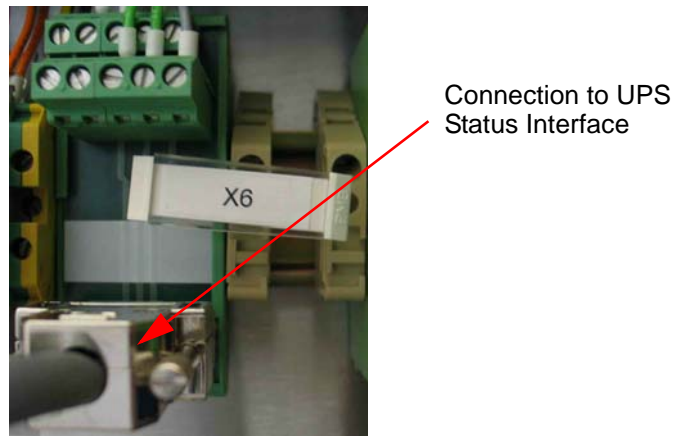

Figure 5.15: Line Control Unit Connector X6

Pin Number	Pin Function
1	Not connected
2	Not connected
3	General alarm (normally opened)
4	On commercial AC (normally closed)
5	Ground
6	UPS on bypass (normally opened)
7	Battery low (normally opened)
8	UPS present (normally closed)
9	Not connected

Table 5.8 Pin Count Connector X6

i The cable HZ13979 must be connected to connector X6 or it is not possible to switch on the console output and to detect commercial power failures.

6 Transport, Packaging and Storage

6.1 Symbols on the Packaging

The following symbols are affixed to the packaging material. Always observe the symbols during transport and handling.

Top



The arrow tips on the sign mark the top of the package. They must always point upwards; otherwise the content may be damaged.

Fragile



Marks packages with fragile or sensitive contents.

Handle the package with care; do not allow the package to fall and do not allow it to be impacted.

Protect Against Moisture



Protect packages against moisture and keep dry.

Attach Here



Lifting gear (lifting chain, lifting strap) must only be attached to points bearing this symbol.

Center of Gravity



Marks the center of gravity of packages.

Note the location of the center of gravity when lifting and transporting.

Weight, Attached Load



Indicates the weight of packages.

Handle the marked package in accordance with its weight.

Permitted Stacking Load



Indicates packages which are partially stackable.

Do not exceed the maximum load-bearing capacity specified on the symbol in order to avoid damaging or destroying the content.

Do not Damage Air-tight Packaging



The packaging is air-tight. Damage to the barrier layer may render the contents unusable.

Do not pierce.

Do not use sharp objects to open.

Component Sensitive to Electrostatic Discharge (ESD)



The packaging contains components which are sensitive to an electrostatic discharge.

Only allow packaging to be opened by trained personnel.

Establish potential equalization before opening.

Protect from Heat

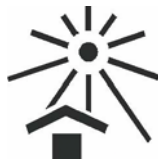

Protect packages against heat and direct sunlight.

Protect from Heat and Radioactive Sources



Protect packages against heat, direct sunlight and radioactive sources.

6.2 Inspection at Delivery

Upon receipt, immediately inspect the delivery for completeness and transport damage.

Proceed as follows in the event of externally apparent transport damage:

- Do not accept the delivery, or only accept it subject to reservation.
- Note the extent of the damage on the transport documentation or the shipper's delivery note.
- Initiate complaint procedures.

i Issue a complaint in respect to each defect immediately following detection. Damage compensation claims can only be asserted within the applicable complaint deadlines.

6.3 Packaging

About Packaging

The individual packages are packaged in accordance with anticipated transport conditions. Only environmentally friendly materials have been used in the packaging.

The packaging is intended to protect the individual components from transport damage, corrosion and other damage prior to assembly. Therefore do not destroy the packaging and only remove it shortly before assembly.

Handling Packaging Materials

Dispose of packaging material in accordance with the relevant applicable legal requirements and local regulations.

6.4 Storage

Storage of the Packages

Store the packages under the following conditions:

- Do not store outdoors.
- Store in dry and dust-free conditions.
- Do not expose to aggressive media.
- Protect against direct sunlight.
- Avoid mechanical shocks.
- Storage temperature: 15 to 35 °C.
- Relative humidity: max. 60%.

If stored for longer than 3 months, regularly check the general condition of all parts and the packaging. If necessary, top-up or replace preservatives.

7 Principles of Operation

The BMPC/2 can be operated in two different modes:

- **Manual** mode or,
- **Automatic Pump** mode.

The "Manual Mode" is the standard mode of operation after the unit is turned on or reset. In manual mode all the pumps and valves can be operated manually.

In "Automatic Pump Mode" all the pumps and valves are controlled automatically. This is the preferred mode for the BMPC/2.

7.1 Manual Mode

The operation of the pumps and valves in manual mode takes place with the help of the different buttons located on the front plate of the BMPC/2 control unit. The function of these buttons, which are illustrated in the following diagram, will be discussed in the following sections.

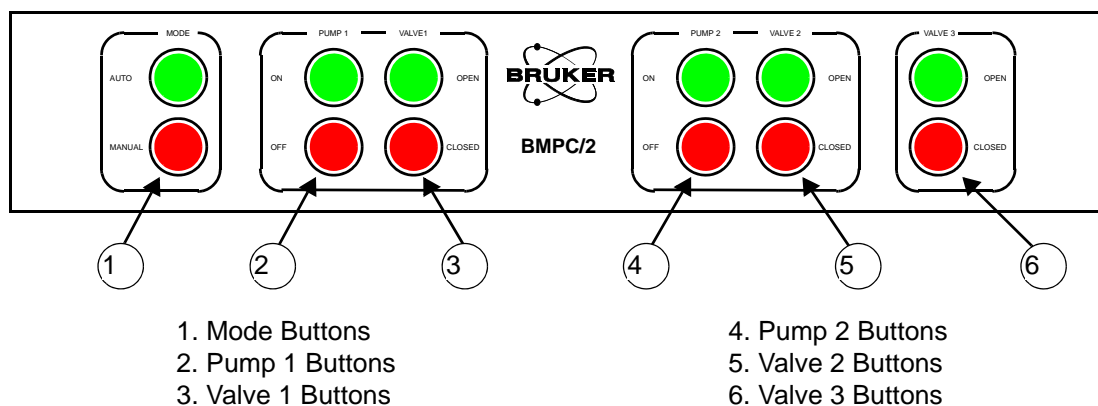

Figure 7.1: BMPC/2 Control Unit Front Plate

7.1.1 Mode Buttons

The mode buttons are used to switch between manual and automatic mode.

To enter automatic mode press the AUTO mode button. The green lamp will activate when the unit switches to automatic mode.

To return to manual mode press the MANUAL button. The green light will deactivate and the red lamp will activate indicating that the unit is in manual mode.

7.1.2 Pump 1 and Valve 1 Buttons

The Pump 1 buttons allows you to turn the pump on or off in manual mode. Likewise, the Valve 1 buttons allow you to open or close valve 1. The pertinent lamps will indicate the current condition:

- The **green lights** will indicate that the pump is running or the valve is open.
- The **red lights** will indicate that the pump is off or the valve is closed.

7.1.3 Pump 2 and Valve 2 Buttons

The Pump 2 and Valve 2 buttons have the same function as the Pump 1 / Valve 1 described in the previous section, the only difference is that they affect Pump 2 and Valve 2.

7.1.4 Valve 3 Buttons

For Aeon magnet systems, the Valve 3 buttons operate the valve that controls the helium recirculation to the cryostat:

- The green light indicates that helium is returned.
- The red light indicates that the pumped helium is exhausted.

If you use a magnet system without helium return, the Valve 3 buttons are not used. When you push the buttons, you will hear a click, but no function will be performed.

NOTICE

Valve 3 should be closed if the helium flow rate is greater than 1.5 times the normal rate.

Valve V3 should only be open if the helium flow rate is below 1.5 times the nominal value.

- ▶ If the helium flow rate is higher (e.g. during energizing), V3 has to be closed.

7.2 Pumps and Valves in Manual Mode

There are several pump and valve configurations available in manual mode:

- Pump 1 on together with Valve 1 opened,
- Pump 2 on with Valve 2 opened, or
- Both pumps on with both valves opened.
- Valve 3 individually opened or closed.

In manual mode the condition of the pumping system is not controlled, thus when a pump or valve is not working correctly the system will not react.

NOTICE

Using the pump in manual mode

When engaging a pump in manual mode it is possible that a return flow of air into the pump line occurs.

- ▶ Always switch the pump on first, then wait 10 to 15 seconds before you open the associated valve.
- ▶ Before switching a pump off, always close the associated valve first!

CAUTION



Never open Valve 1 when Pump 1 is not running, or Valve 2 when Pump 2 is not running.

This can result in a return flow of air into the pump line and an increase in the magnet temperature.

- ▶ When using Pump 1, first close Valve 2.
- ▶ When using Pump 2, first close Valve 1.

NOTICE

In manual mode the BMPC/2 will not react to critical magnet parameters

When, for example, the helium flow is too low the Pump 2 will not automatically switch on. However, when the BMPC/2 software is operating in Monitor & Alarm mode, you will nevertheless be alarmed when important magnet parameters exceed or fall below their limit values.

- ▶ Always place the BMPC/2 software in Monitor & Alarm mode when working in manual mode.

Refer to the section "[Monitor & Alarm Mode](#)" on page 58 for more information on the BMPC/2 software.

7.3 Automatic Pump Mode

Valve 3 can be controlled manually, even if the BMPC/2 is in automatic mode. During normal operation, V3 should be open for helium recovery.

NOTICE

Valve 3 should be closed if the helium flow rate is greater than 1.5 times the normal rate.

Valve V3 should only be open if the helium flow rate is below 1.5 times the nominal value.

► If the helium flow rate is higher (e.g. during energizing), V3 has to be closed.

In automatic pump mode all the pumps and valves are controlled automatically. It is not possible to operate a pump or valve manually using the front panel buttons when the system is in automatic mode.

To change to automatic pump mode when you are in manual mode press the AUTO button. The green lamp indicates when the unit is in automatic pump mode.

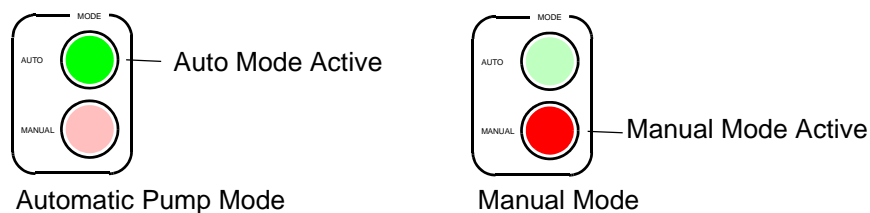

Figure 7.2: Automatic Pump Mode vs. Manual Pump Mode

7.3.1 The Default Pump

The default pump that is used when the unit is switched to automatic mode depends on which, if any, pump is operating:

- If one pump is running, this will become the default pump.
- If both pumps are running, they will both be regarded as default pumps.
- If no pump is running then, Pump 1 will be used as default.

7.3.1.1 Default Pump Failure

The BMPC/2 continuously monitors the condition of the default pump(s) in operation. If one of the pumps or valves malfunctions:

1. The malfunctioning pump (or valve) and its corresponding valve (or pump) are stopped or closed.

2. Either the other pump switches on automatically and the corresponding valve is opened, or, when both pumps were operating, the other pump will continue to operate and its corresponding valve will remain open.
3. The BMPC/2 software will display an error message indicating the current problem.

7.4 Monitoring and Pump Control in Automatic Pump Mode

Along with several other values, the BMPC/2 measures the following parameters:

- P1 Pressure
- T1/T2 Temperature
- FL Helium Flow

These parameters are imposed with limit values, and the two pumps are switched accordingly.

When one of these magnet parameters exceeds its limit values, the BMPC/2 activates the second pump, which will always operate for at least 1 hour. Afterwards the pump may continue to run for an additional hour or will be switched off depending on the current system status.

7.4.1 P1 Pressure Monitoring

The P1 pressure is continuously monitored against a pre-specified upper and lower limit and the following actions taken if one of these limits is reached:

Precondition	Condition	Action
	P1 pressure is lower than P1 low warning limit	A warning is triggered .
Software in Monitor & Alarm mode	P1 pressure is lower than the P1 low alarm limit	Alarm cycle is activated
	P1 pressure is higher than the P1 high warning limit	Second pump is started and a warning is triggered
Software in Monitor & Alarm mode	P1 pressure is higher than the P1 high alarm limit	Second pump is started and the alarm cycle is activated

Table 7.1 P1 Pressure Monitoring

7.4.2 T1/T2 Temperature Monitoring

The T1 and T2 temperatures are continuously monitored against a pre-specified lower limit and the following actions taken if the limit is reached:

Precondition	Condition	Action
	The resistance of the temperature sensor T1 or T2 temperature is lower than the T1/T2 warning value	Second pump is started and a warning is triggered
Software in Monitor & Alarm mode	The resistance of the temperature sensor T1 or T2 temperature is lower than the T1/T2 alarm value	Second pump is started and the alarm cycle is activated

Table 7.2 T1/T2 Temperature Monitoring

7.4.3 FI Helium Flow Monitoring

The FI helium flow value is continuously monitored against a pre-specified lower limit and the following actions taken if the limit is reached:

Precondition	Condition	Action
	FL value is lower than the flow warning value	Second pump is started and a warning is triggered
Software in Monitor & Alarm mode	FL value is lower than the flow alarm value	Second pump is started and the alarm cycle is activated

Table 7.3 FL Helium Flow Monitoring

8 Software

The BMPC/2 control & monitoring software is the user interface for the entire BMPC/2. The software is necessary for adjustment of all the important BMPC/2 and magnet system parameters, as well as for the monitoring of all functions during normal operation.

8.1 Starting the BMPC/2 Software

To start the BMPC/2 Control software you will need to enter your account ID and password and press „Enter“. The account ID and password can be delegated from the Administrator or Bruker Service. There are several different account levels available:

User - Standard User Level

This is the default user display mode. In this mode you can switch between the various display modes with the following restrictions:

- To change to the „Off mode“ it is necessary to reenter the user password.
- The functions under the *Tools* menu option are not available at this login level.
- The program can not be closed in user level.

Administrator - Revisionary Level

This mode is necessary for making changes in the BMPC/2 setup. Most of the functions under the menu option *Tools* are available at this level, with a few exceptions that are reserved for the Service level. The program can be closed while in administrator level.

Service - Service Level

This level is only accessible by Bruker service personnel and is only required during installation. For more information on accounts and passwords refer to the section "[Password & Codes](#)" on page 87.

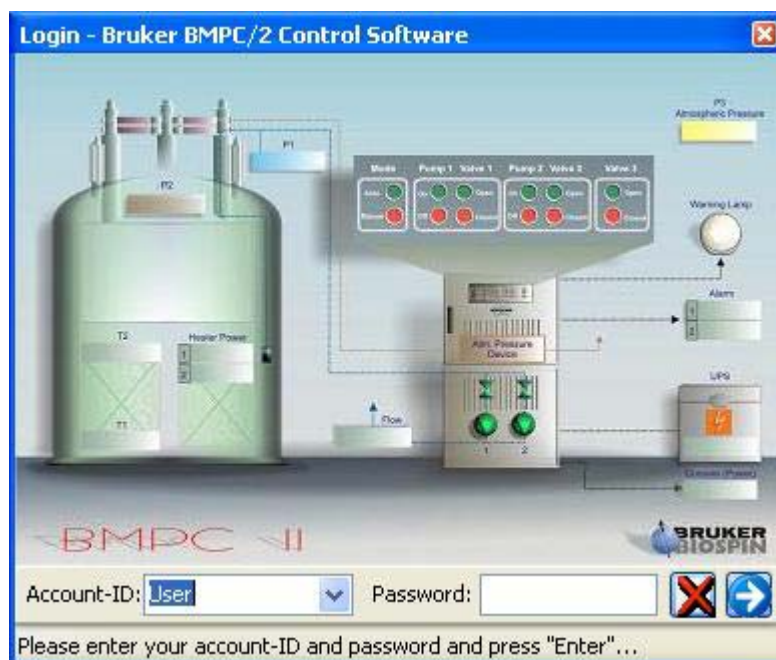

Figure 8.1: BMPC/2 Login Screen

8.2 Program Overview

The software interface consists of five different "Display Modes":

- Process Display
- Graphical Display
- Jumbo Display
- Data Log Display
- Present Values/Events Display

The interface also has four different "Operation Modes":

- Off
- Monitor Only
- Monitor & Alarm
- He Fill

These various display and work modes will be described in detail in this chapter. The following screen organization is used in all the display modes.

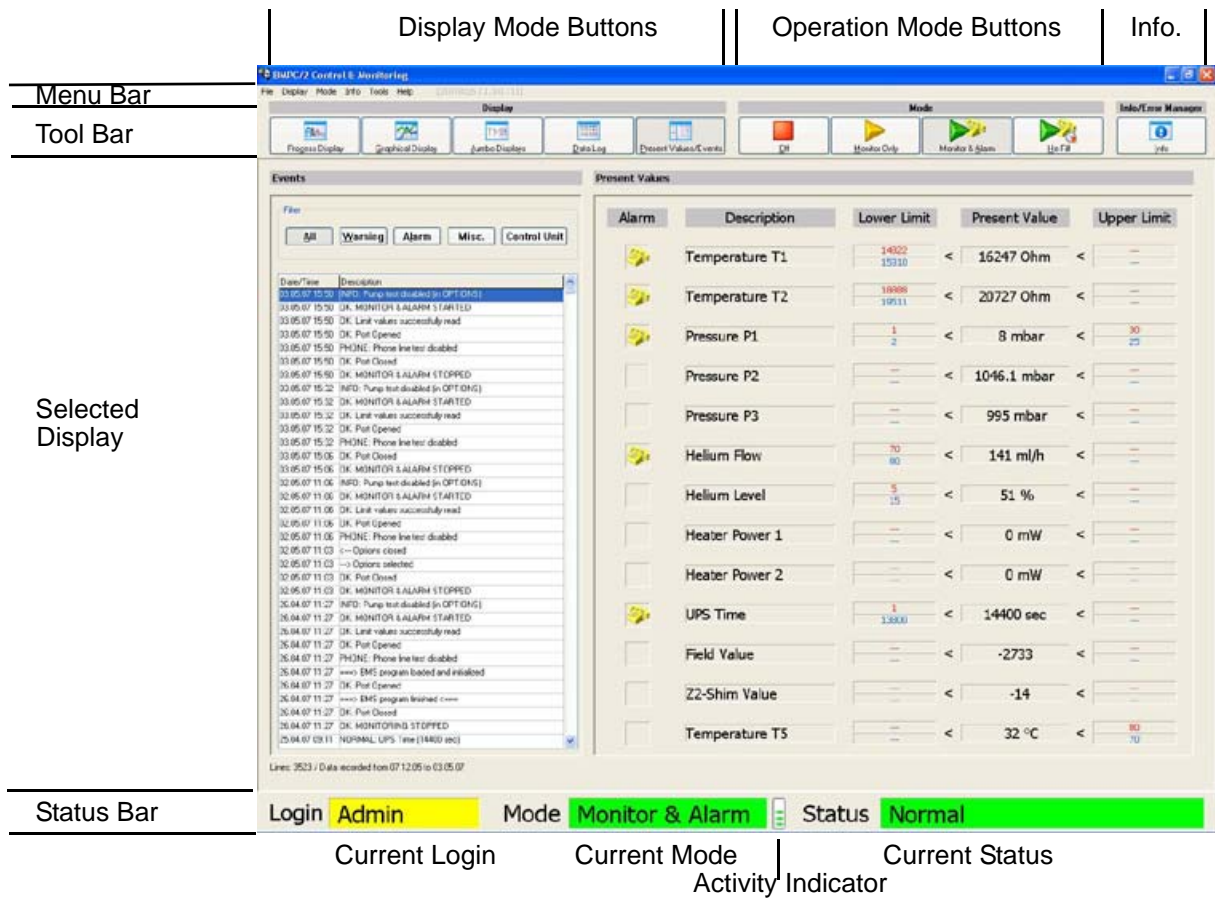

Figure 8.2: Display Organization

The top of the screen contains a standard Windows menu bar. Just under this is a tool bar which contains buttons providing quick access to the five different display modes, the four operation modes, as well as system information.

Under the tool bar, there is an area where the selected display mode is displayed. This will vary based on the mode you have selected. In the above example the Present Value/Event display is shown.

At the lower edge of the screen the current status of the system is shown. This includes the current user login, the current mode and the current system status.

The activity level is also displayed at the bottom of the screen and indicates that communication between the IPC and the control unit is taking place. This is continuously updated based on the current activity.

8.3 Display Modes

The five display buttons allow easy access between the five different display modes. To select a display mode click on one of the buttons.



Figure 8.3: Display Buttons

8.3.1 Process Display

The process display is the default display in display mode. The most important magnet and BMPC/2 parameters are indicated in a representative process image. Thus, a correlation of the parameters to their functions is available at any given time.

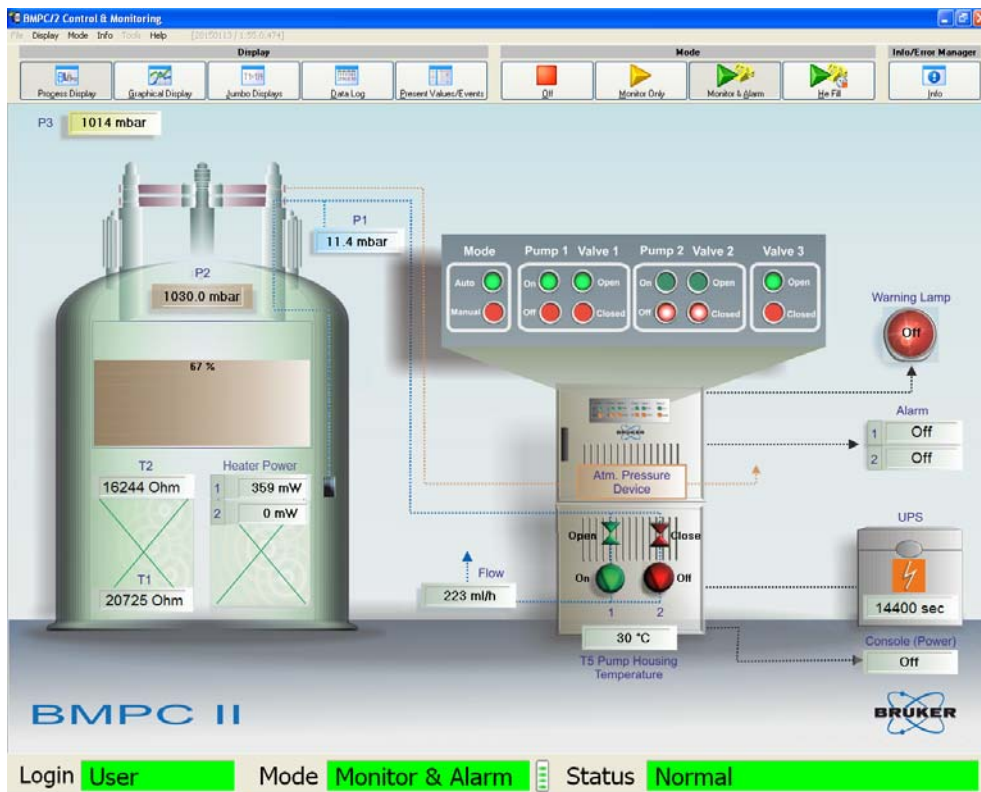

Figure 8.4: Process Display without Compressor

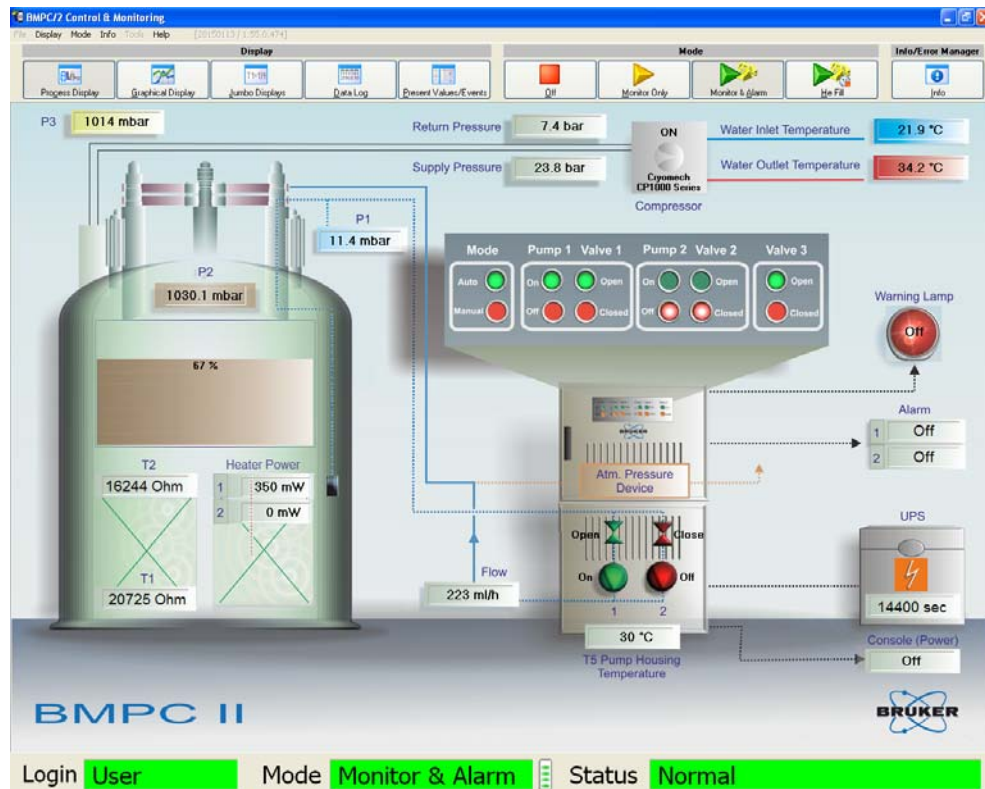

Figure 8.5: Process Display with Compressor

8.3.2 Graphical Display

The graphical display allows you to plot arbitrary parameters on a timeline. Up to 3 different graphs can be represented simultaneously on the display screen. The graphical display is freely configurable based on specific needs.

Configuration

Graph 1
T1 and T2

Graph 2
P2 and P3

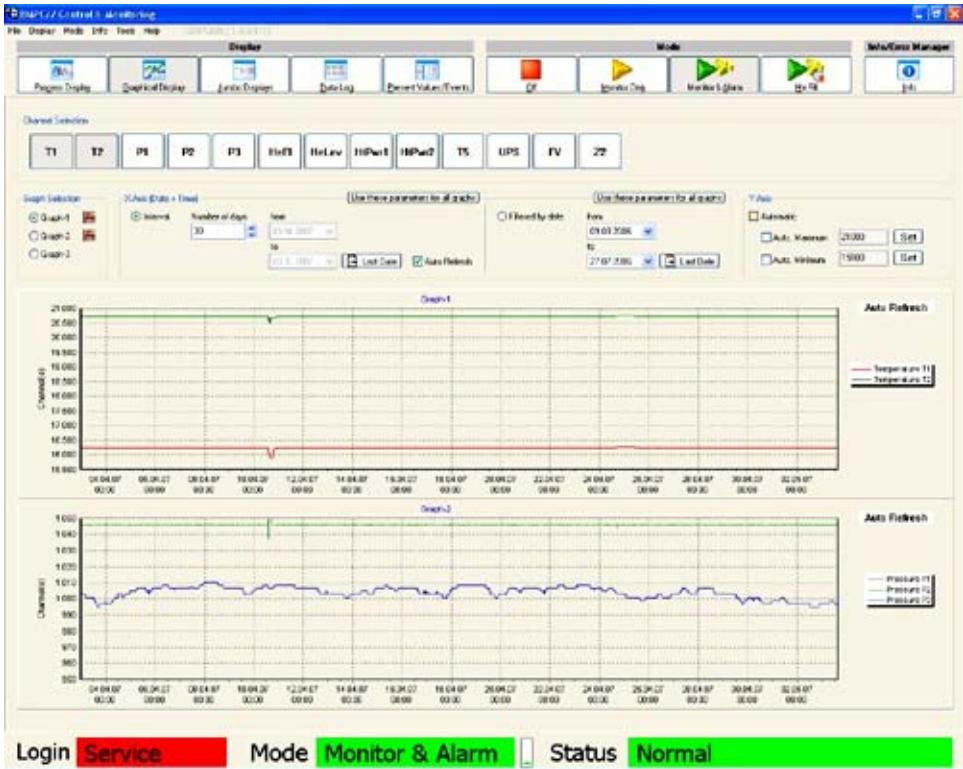

Figure 8.6: Graphical Display

In the example above is a configuration for two graphs. The settings for both graphs are identical. In both examples data for the last 30 days is represented. Whenever new data is added to the log file the graphical display is automatically updated (refreshed).

8.3.2.1 Configuration of the Graphical Display

At the top half of the graphical display are several checkboxes and fields that can be used to configure the graphical display representation to your individual needs. By selecting or deselecting checkboxes and/or entering parameters you can specify your requirements.

For example, you can select up to 3 channels from the Channel Selection bar to be displayed on the selected graph. In the example below T1 and T2 parameters for Graph 1 have been selected (Group Box „Graph Selection“).

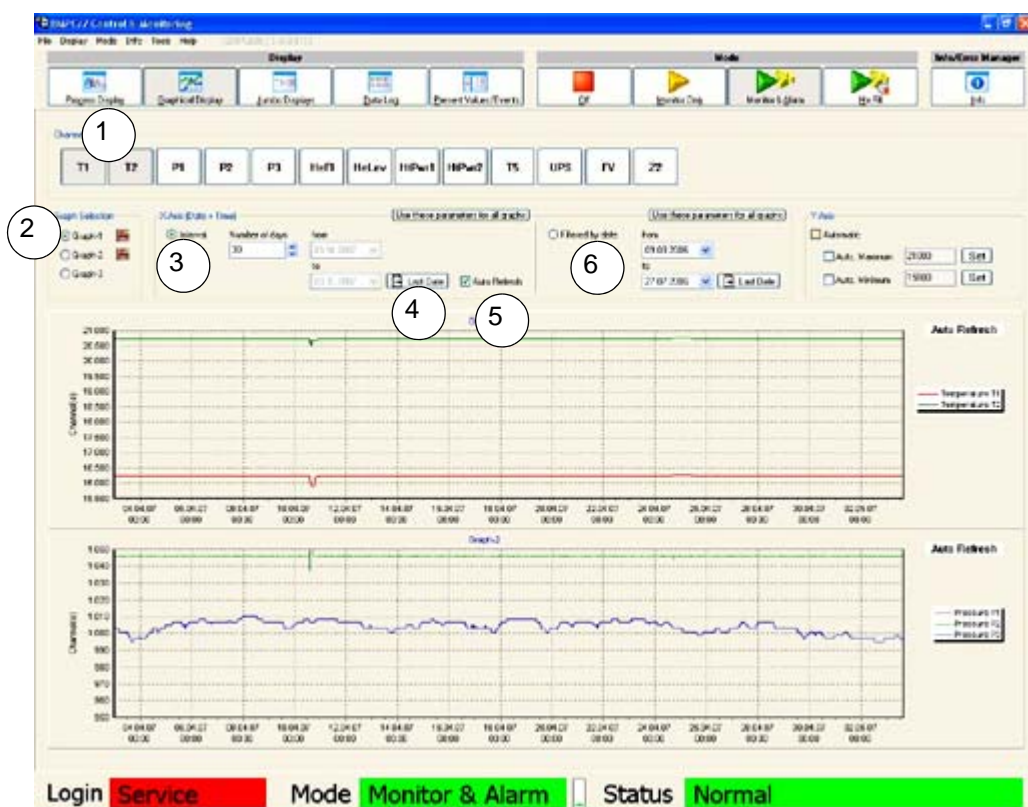

- | | |
|------------------------------|-------------------------------|
| 1. Channel Selection T1 & T2 | 4. Last Date |
| 2. Graph Selection Graph 1 | 5. Auto Refresh |
| 3. Interval Selection | 6. Filtered by Date Selection |

Figure 8.7: Graphical Display - Configuration X-axis

For each graph you can subsequently configure the X-axis (time) and the Y-axis (size) display to conform to individual requirements.

The configuration of the X-axis can either be an interval display or a filtered display based on a specified date.

- **Interval display:** The desired number of days to be represented, as well as the final date can be entered. The last logbook entry can be displayed by clicking on „Last Date“. When you also select the auto-refresh option the graphical display will be automatically updated when a new logbook entry is made. In this case entering a Last Date is not possible.

- **Filtered display:** If you want to view the data within a certain timeframe, you can do so by entering a beginning and ending date.

The adjustments that have been made will automatically be used for all the other graphs when you click on the „Use these parameters for all graphs“ button. Subsequently they will all use the same time axis.

The adjustment of the Y-axis can take place automatically or manually.

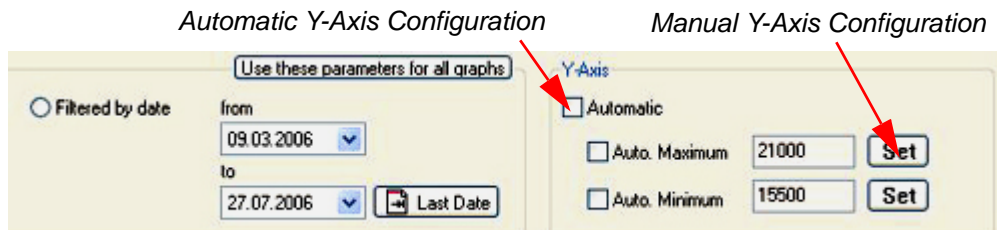

Figure 8.8: Graphical Display - Configuration Y-axis

- **Automatic:** When the checkbox Automatic is selected, the range of values is computed automatically based on the maximum and minimum values that have to be displayed. You can either select both, the maximum and the minimum to be computed automatically or just the maximum or just the minimum
- **Manual:** When the Automatic checkbox is not selected, you can manually select the values by pressing the corresponding Set button and entering the values in the dialog window that appears.

The manual mode is useful when a value does not change over the entire given period and thereby the display of the upper and lower margins will always appear in the field of view.

8.3.2.2 Zoom Function

To improve the resolution, you can use the zoom function to enlarge parts of the graphical data.

To zoom **in** press the left mouse button and select an area moving the mouse from the **upper left** corner to the **lower right** corner.

To zoom **out** press the left mouse button and select an area moving the mouse from the **lower right** to the **upper left** corner.

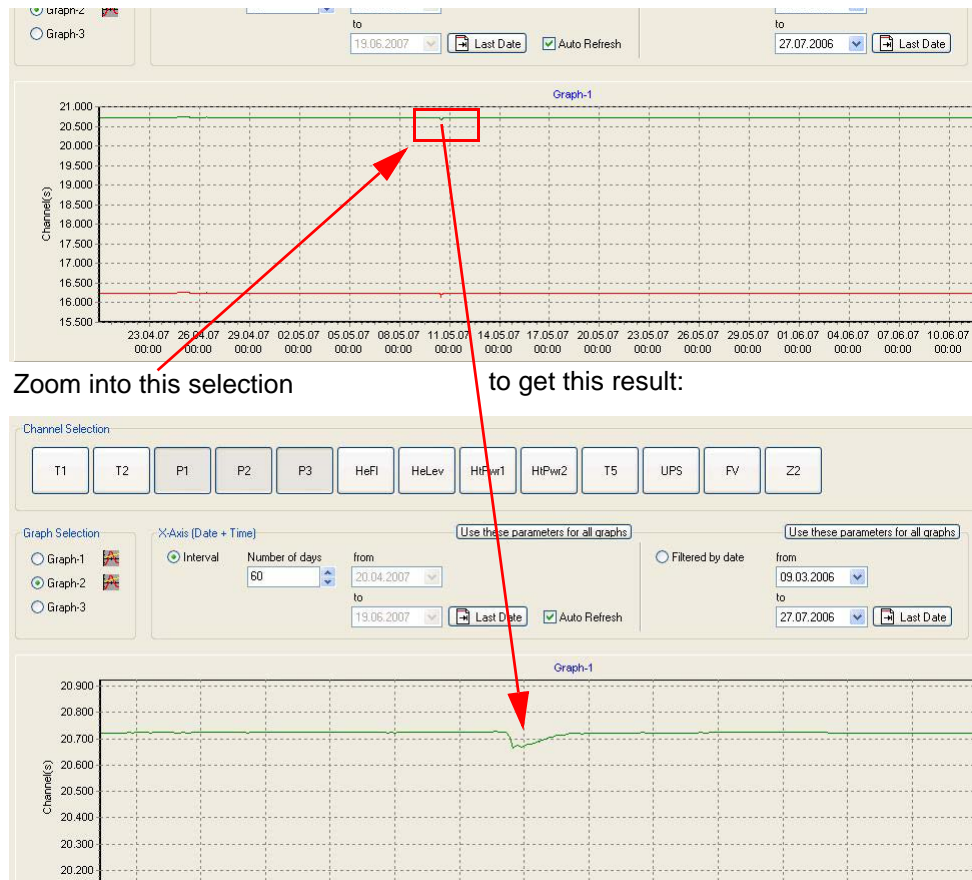

Figure 8.9: Graphical Display - Zoom Function

8.3.3 Jumbo Display

In Jumbo display mode you can display up to 5 parameters using an extra large font size. This is useful if you want to read the displayed values when you are at a greater distance from your monitor.

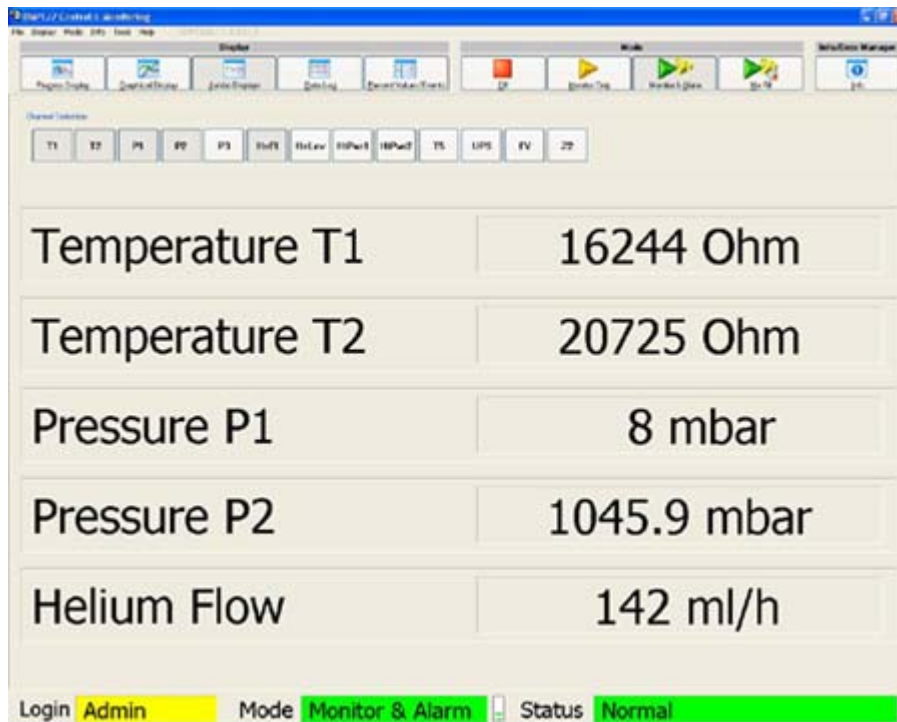
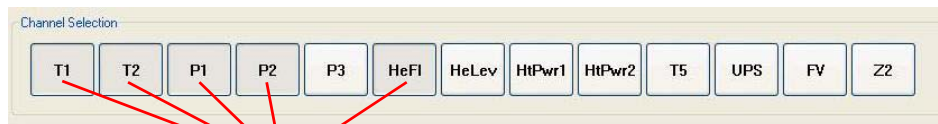

Figure 8.10: Jumbo Display

8.3.3.1 Configuration of the Jumbo Display

To activate or deactivate parameters displayed in the Jumbo Display press the corresponding channel button (e.g. T1, T2, etc.).



These channels have been selected to display in the Jumbo Display

Figure 8.11: Jumbo Display Configuration

The buttons that are grayed out are the parameters that are currently displayed using the extra large font size in the Jumbo Display window.

The order in which the individual parameters are displayed in the Jumbo Display depend on the order in which the channels are selected.

8.3.4 Data Log Display

The Data Log display is in the broadest sense a database browser. In this display you can display all the parameter data that is stored in the database.

The screenshot shows the 'Data Log Display' window in the 'BMPC/2 Control & Monitoring' application. The window title is 'BMPC/2 Control & Monitoring' and the version is '20070226 / 1.0.0.111'. The interface includes a menu bar (File, Display, Mode, Info, Tools, Help) and a toolbar with buttons for 'Display' (Progress Display, Graphical Display, Jumbo Displays, Data Log, Present Values/Events), 'Mode' (Off, Monitor Only, Monitor & Alarm, Up FA), and 'Info/Error Manager' (Info). Below the toolbar is a 'Channel Selection' section with buttons for T1, T2, P1, P2, P3, HeFl, HeLev, HPwr1, HPwr2, T5, UPS, FV, and ZZ. The 'Next Log Time' is 16:00. The main area is a table with columns for Date/Time and the selected channels. The table shows a list of data points with values for each channel. At the bottom, there is a status bar with 'Login Admin', 'Mode Monitor & Alarm', and 'Status Normal'.

Date/Time	T1	T2	P1	P2	P3	HeFl	HeLev	HPwr1	HPwr2	UPS	FV	T5
03.05.07 15:50	16242	20724	0	1046.0	995	141	51	0	0	14400	-2733	32
03.05.07 16:40	16244	20724	0	1046.0	995	141	51	0	0	14400	-2733	32
03.05.07 16:32	16244	20724	0	1046.0	995	141	51	0	0	14400	-2733	32
03.05.07 15:00	16241	20723	0	1046.1	996	141	51	0	0	14400	-2733	32
03.05.07 14:40	16241	20722	0	1045.9	997	141	51	0	0	14400	-2733	32
03.05.07 14:20	16241	20723	0	1045.9	997	141	51	0	0	14400	-2733	32
03.05.07 14:00	16240	20722	0	1046.1	997	141	51	0	0	14400	-2733	32
03.05.07 13:40	16240	20722	0	1046.1	997	141	51	0	0	14400	-2733	32
03.05.07 13:20	16240	20722	0	1046.0	997	141	51	0	0	14400	-2733	32
03.05.07 13:00	16241	20723	0	1045.9	997	141	51	0	0	14400	-2733	32
03.05.07 12:40	16241	20724	0	1046.0	997	141	51	0	0	14400	-2733	32
03.05.07 12:20	16240	20722	0	1046.0	997	142	51	0	0	14400	-2733	32
03.05.07 12:00	16240	20722	0	1046.0	997	141	51	0	0	14400	-2733	32
03.05.07 11:40	16239	20721	0	1046.0	997	141	51	0	0	14400	-2733	32
03.05.07 11:20	16238	20721	0	1046.0	997	141	51	0	0	14400	-2733	32
03.05.07 11:00	16239	20722	0	1046.0	998	142	51	0	0	14400	-2733	32
03.05.07 10:40	16241	20722	0	1046.1	999	143	51	0	0	14400	-2733	32
03.05.07 10:20	16240	20722	0	1046.0	998	143	51	0	0	14400	-2733	32
03.05.07 10:00	16239	20722	0	1045.9	998	143	51	0	0	14400	-2733	32
03.05.07 09:40	16243	20725	0	1045.9	999	145	51	0	0	14400	-2733	32
03.05.07 09:20	16241	20724	0	1046.0	999	145	51	0	0	14400	-2733	32
03.05.07 09:00	16241	20724	0	1046.1	999	145	51	0	0	14400	-2733	32
03.05.07 08:40	16241	20723	0	1045.9	999	145	51	0	0	14400	-2733	32
03.05.07 08:20	16242	20724	0	1046.1	999	145	51	0	0	14400	-2733	32
03.05.07 08:00	16241	20723	0	1045.9	998	145	51	0	0	14400	-2733	32
03.05.07 07:40	16241	20723	0	1046.0	998	145	51	0	0	14400	-2733	32
03.05.07 07:20	16240	20721	0	1046.0	998	146	51	0	0	14400	-2733	32
03.05.07 07:00	16241	20722	0	1046.0	997	145	51	0	0	14400	-2733	32
03.05.07 06:40	16238	20720	0	1046.0	997	142	51	0	0	14400	-2733	32
03.05.07 06:20	16238	20720	0	1046.0	997	136	51	0	0	14400	-2733	32
03.05.07 06:00	16239	20721	0	1046.0	997	138	51	0	0	14400	-2733	32
03.05.07 05:40	16239	20721	0	1046.0	997	139	51	0	0	14400	-2733	32
03.05.07 05:20	16239	20721	0	1046.1	997	136	51	0	0	14400	-2733	32
03.05.07 05:00	16239	20721	0	1046.0	997	136	51	0	0	14400	-2733	32

Lines: 83655 / Data recorded from 26.10.05 to 03.05.07

Login Admin Mode Monitor & Alarm Status Normal

Figure 8.12: Data Log Display

To activate or deactivate a specific parameter press the corresponding channel select button. The channels are arranged from left to right in the order of selection. When more channels are selected than can be displayed in one screen, a horizontal scrollbar will appear which allows you to scroll to the other parameters.

When a large quantity of data is stored in the data log file, it may take longer for the data to be displayed.

Refer to "[Sensor Channels](#)" on page 94 for details on how to configure database entries.

8.3.5 Present Values/Event Display

The Present Values/Events display:

- Provides a quick overview of how the system is configured.
- Indicates whether there are any events which must be examined.
- Can be used to present the current data in a simple table representation.

The screenshot shows the 'BMPC/2 Control & Monitoring' software interface. The 'Events' panel on the left contains a filter section with buttons for 'All', 'Warning', 'Alarm', 'Misc.', and 'Control Unit'. Below the filter is a list of events with columns for 'Date/Time' and 'Description'. The 'Present Values' panel on the right displays a table of monitored parameters:

Alarm	Description	Lower Limit	Present Value	Upper Limit
<input type="checkbox"/>	Temperature T1	14822 15310	< 16243 Ohm	< ---
<input type="checkbox"/>	Temperature T2	10899 19511	< 20724 Ohm	< ---
<input type="checkbox"/>	Pressure P1	1 2	< 8 mbar	< 30 25
<input type="checkbox"/>	Pressure P2	---	< 1045.9 mbar	< ---
<input type="checkbox"/>	Pressure P3	---	< 995 mbar	< ---
<input type="checkbox"/>	Helium Flow	70 80	< 141 ml/h	< ---
<input type="checkbox"/>	Helium Level	5 15	< 51 %	< ---
<input type="checkbox"/>	Heater Power 1	---	< 0 mW	< ---
<input type="checkbox"/>	Heater Power 2	---	< 0 mW	< ---
<input type="checkbox"/>	UPS Time	1 13800	< 14400 sec	< ---
<input type="checkbox"/>	Field Value	---	< -2733	< ---
<input type="checkbox"/>	Z2-Shim Value	---	< -14	< ---
<input type="checkbox"/>	Temperature T5	---	< 32 °C	< 80 70

At the bottom of the interface, the status bar shows 'Login Level' (Admin), 'Current Mode' (Monitor & Alarm), and 'System Status' (Normal).

Figure 8.13: Present Values/Events Display

The Events section of the Present Values/Events display shows all the warnings, alarms, system messages, as well as, all error messages of the monitored components/devices, like the BMPC/2 Control Unit, PTC Compressor (optional), BMU (optional) or HLMU (optional). The Event log filter buttons on the upper part of the display allow you to select data that is relevant for your purposes.

The alarm configuration field in the Present Values block indicates which channels will trigger an alarm when a malfunction occurs in Monitor & Alarm Mode (refer to "[Monitor & Alarm Mode](#)" on page 58). More information on configuring alarms can be found in "[Alarm Configuration](#)" on page 66.

If you are logged in as a user or administrator, the display automatically will change to the Present Values / Event mode every time a new entry is written in the Event log.

8.4 Operation Modes

The BMPC/2 user interface offers four different operational modes which can be accessed by pressing the corresponding mode buttons.



Figure 8.14: Mode Buttons

8.4.1 OFF Mode

The **OFF** mode is necessary when the Administrator needs to change the software attributes using the menu option *Tools*. The *Tools* menu option is only accessible when you press the *Off* button in the toolbar. If you are logged in as User or Administrator you will be required to reenter your password to confirm the mode change.

The program can only be terminated if Off mode is selected.

-
- i** In Off mode **no** data is written to the log files!
The alarms are deactivated in Off mode. When a magnet or BMPC/2 malfunction occurs you will **not** be informed through an alarm!
-

8.4.2 Monitor Only Mode

In this mode the current values of all magnet and BMPC/2 data are displayed, but the **alarms are deactivated**. The data is saved in the Data Log File when operating in this mode.

-
- i** In this mode the alarms are deactivated, thus you must be aware that you are not operating at the highest safety level. When a magnet or BMPC/2 malfunction occurs you will **not** be informed through an alarm!
-

8.4.3 Monitor & Alarm Mode

In this mode current values of all magnet and BMPC/2 data are displayed, and the **alarms are activated**, whereas you will be informed if a malfunction occurs. The data is saved in the Data Log File when operating in this mode.

In the following example the Temperature T1, Temperature T2, Pressure P1, Helium Flow and UPS Time channel alarms are enabled. When one of these parameters exceeds its corresponding alarm limit values, an alarm will be activated.

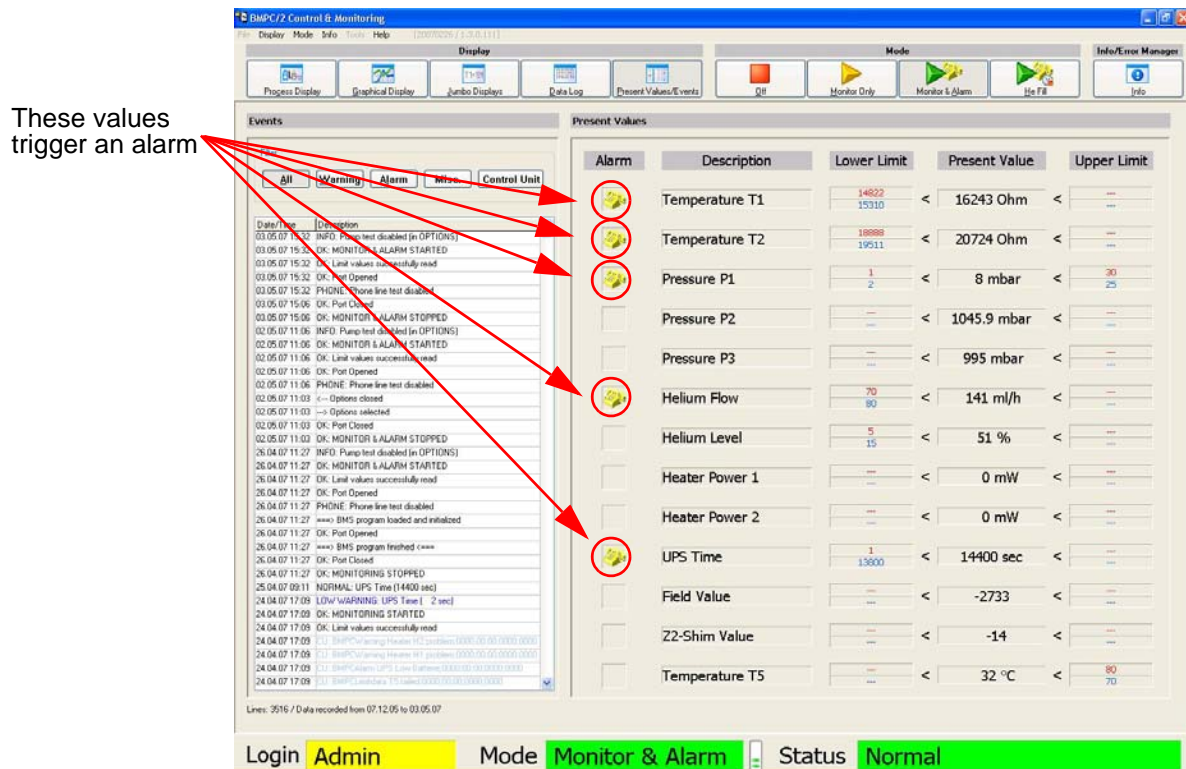

Figure 8.15: Present Values Display in Monitor & Alarm Mode

In the example below a low alarm limit of 14826 and a low warning limit of 15312 have been set for the Temperature T1 value. If the value for the Temperature T1 falls below the low warning limit value, the warning sequence is started. This means that the warning light appears and an entry is added to the event log file.

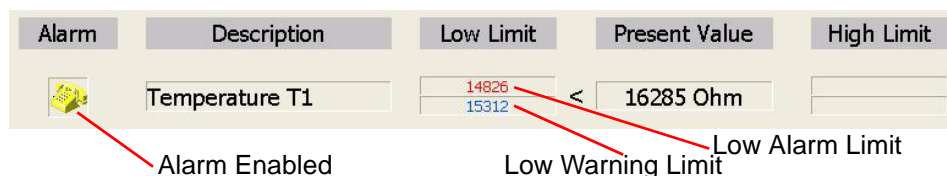

Figure 8.16: Temperature T1 in the Present Value Display

When an alarm is enabled, then an alarm will be triggered when an alarm limit value is exceeded. In this case an entry will be added to the event log file and the telephone alert notification will begin. Details on alarm procedures are discussed in the chapter "[Alarm System](#)" on page 65.

8.4.4 He Fill Mode

The He Fill mode is necessary because the T1 and/or T2 parameters may briefly fall below the alarm threshold during the helium refill process. In order to avoid an alarm from being triggered the He Fill mode can be used to suppress the T1/T2 alarm for up to six hours.

The P2 pressure control heater is also disabled for one hour, as this is not efficient when the magnet is open and thus would only lead to unnecessary helium consumption.

When the He Fill mode is activated it is indicated in the status bar together with the length of fill time remaining.

Mode **He Fill [292 min.]**

Figure 8.17: He Fill Mode 292 Minutes

The suppressed alarms are represented in the Present Values/Events display as indicated in the figure below.

Alarm temporarily disabled



Alarm	Description	Low Limit	Present Value	High Limit
	Temperature T1	14826 15312	< 16286 Ohm	
	Temperature T2	18888 19509	< 20756 Ohm	

Figure 8.18: Alarm Temporarily Disabled

Once the helium refill is finished and the remaining time has expired, the program will automatically leave He Fill mode and return to Monitor only mode or Monitor & Alarm mode.

For information on configuration the He Fill mode read ["He-Refill / He Measurement"](#) on [page 96](#).

8.5 Automatic Pump Test

The Automatic Pump Test is a software activated test used to ensure that the second pump is operational. During normal operation only one of the BMPC/2 vacuum pumps is needed, the other pump is only required in the event of a malfunction. To ensure correct operation, the second pump should be tested on a regular basis using the Automatic Pump Test.

During the pump test the spare pump replaces the active pump and the P1 pressure and FL helium flow are monitored. When the pump is working correctly, these parameters should only deviate within a given range.

To prevent false alarms during the automatic pump test, all alarms are temporarily disabled.

i The automatic pump test is only possible if the BMPC/2 is running in automatic mode!

8.5.1 Description of the Test Cycle

The automatic pump test consists of the following series of events:

1. The spare pump is switched on.
2. The helium flow is monitored for 1 minute.
3. When the pump is operating correctly, a short increase in the helium flow can be seen and the test will proceed to the next step.

The spare pump's valve should now be open and the original valve closed. The pump under test is now working, but the original pump is also still operating.

4. The pump will run for a minute until the values for P1 and FL have re-stabilized.
5. After the values have stabilized they will be monitored for a minute. When both parameters do not deviate more than +/- 15% from the original value than the **pump test is successful**.
6. After a successful test the valves are switched back to their original position, and after a 15 second delay, the pump under test is switched off.

The original pump should be running and a decrease of the helium flow should be observed. This decrease is due to a backflow of gas between the helium flow sensor and the pump under test and its valve.

7. The cycle is complete after another minute when all the values have stabilized.

When a **problem occurs** during the automatic pump test the test cycle is immediately aborted and the original pump configuration restored. An error message is then displayed in the information window and in the event log.

8.5.2 Configuring the Automatic Pump Test

The automatic pump test can be configured to start at a pre-designated date and time.

To configure the automatic pump test:

1. Select the *OFF* mode in the menu bar.
2. Select *Tools - Options - Pump Control - Pump Test*
3. Check the „Enable Automatic Pump Test“ checkbox (Figure 8.19: 1).
4. Select the date and time for the next test (Figure 8.19: 2).
5. Select the interval for the test (Figure 8.19: 3). A pump test once a month (every 4 weeks) is recommended.
6. Press *OK* to apply the configuration.

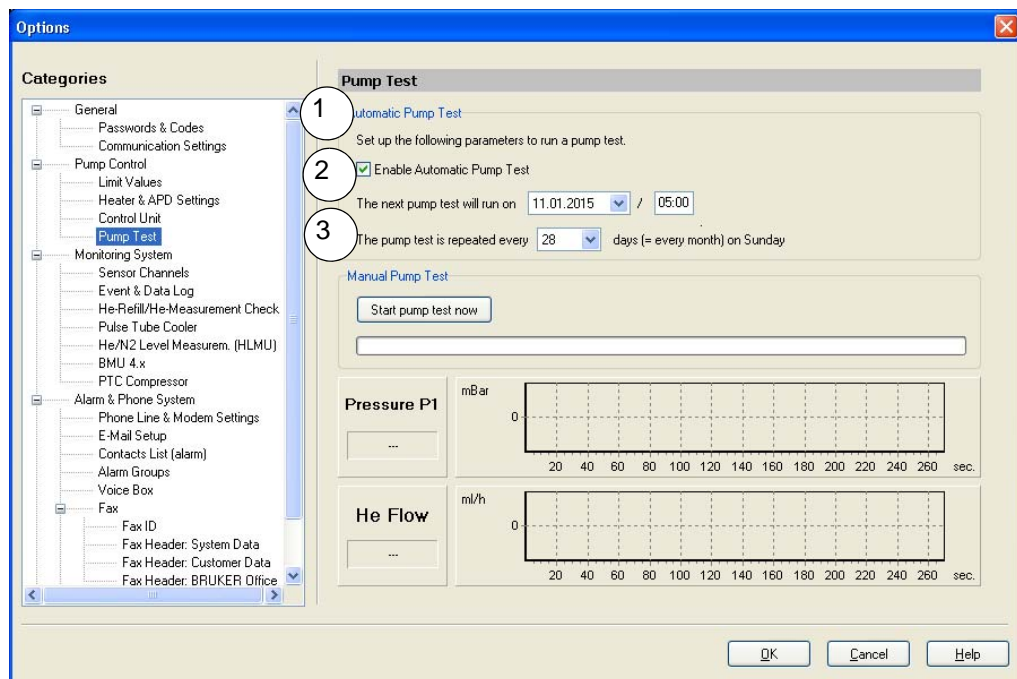

Figure 8.19: Tools - Options - Control Unit - Pump Test - Configuration

After the automatic pump test is configured it may be enabled or disabled using the checkbox listed in step 3 above. The date and time of the next scheduled test is shown in the event log window (display mode „Present Values/Events“) every time you start the Monitoring & Alarm mode (Figure 8.20: 1). If the pump test is disabled this is also shown (Figure 8.20: 2).

Date/Time	Description
10.05.07 16:07	INFO: Next pump test will start on 24.05.07 09:00
10.05.07 16:07	OK: MONITOR & ALARM STARTED

Date/Time	Description
11.05.07 08:45	INFO: Pump test disabled (in OPTIONS)
11.05.07 08:45	OK: MONITOR & ALARM STARTED

Figure 8.20: Event Log - Pump Test

8.5.3 Manual Start of the Pump Test

It is also possible to check the function of the spare pump manually. To start the pump test manually:

1. Select the *OFF* mode in the menu bar.
2. Select *Tools - Options - Pump Control - Pump Test*.
3. Ensure that the checkbox „Enable Automatic Pump Test“ is checked.
4. Press the „Start pump test now“ button (Figure 8.21: 1).
5. The pump test will proceed as described in the automatic test. A status bar and text output will show the status of the pump test cycle.

During the test the P1 field will display the P1 pressure and chart the values over time. Likewise the helium flow will be displayed in the He Flow field and the values over time will be charted. In both cases the x-axis will be adjusted automatically.

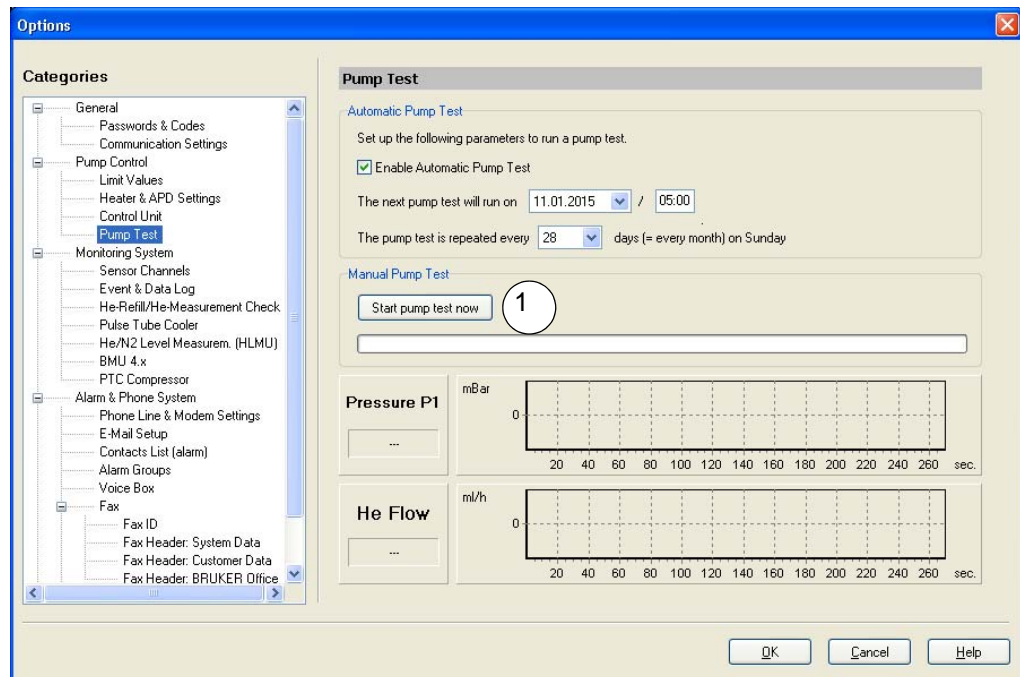

Figure 8.21: Tools - Options - Control Unit - Pump Test

i If the automatic pump test is disabled, a faulty backup pump will not be recognized. Thus when the main pump fails there will be no backup pump which could lead to instabilities of the magnet. This will also trigger an alarm cycle.

9 Alarm System

The alarm system is an important part of the BMPC/2 and is needed for the supervision of the magnet system. The alarm system uses an analog telecommunication network, based on an analog fax modem (with its own modem controller), and normally is available for use worldwide.

9.1 Alarm System Function

When the BMPC/2 is working in the Monitor & Alarm mode, all system parameters are continuously monitored and compared with their limit values. When a parameter exceeds or falls below a given alarm limit, an alarm cycle will be started.

In the following example the alarm cycle was triggered because of a low helium flow. The status field shows that an alarm call was activated and the resulting events logged in the Event Log section.

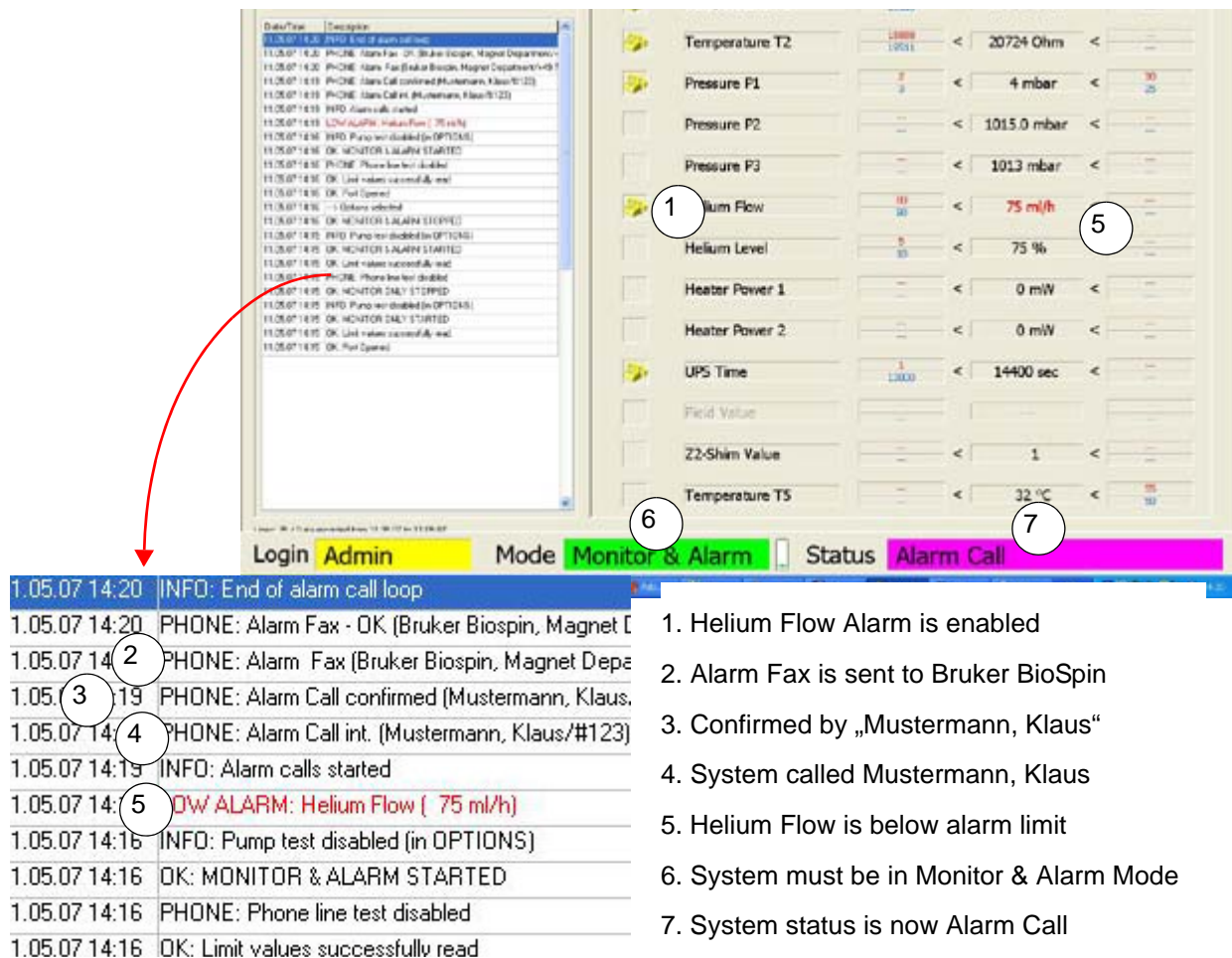

Figure 9.1: Present Values/Events in Alarm Mode

9.2 Alarm Configuration

All channels that have the option „Alarm Trigger“ checked can trigger an alarm cycle. The alarm trigger option can be configured using the function from the menu *Tools - Options - Sensor Channels*. (for additional information see ["Sensor Channels" on page 94](#)).

An alarm will also be triggered if the communication between the industrial PC and the BMPC/2 Control Unit (RS232) fails. This may occur, for example, when a power failure occurs, which lasts longer than the backup time of the external UPS, or which is not protected by the external UPS. The PC then will be powered for 30 more minutes using the internal UPS, whereas an alarm cycle can be initiated during this time.

For Aeon systems, an alarm will also be triggered if communication with the PTC compressor fails (e.g. as a result power outage).

9.3 Alarm Sequence

When the system detects a deviation above or below a limit value, then an alarm cycle will be started.

1. After 30 seconds a check will be made to see if the deviation still exists. When the deviation still exists, the alarm cycle will continue (start calling), otherwise, the alarm cycle will be terminated.

No Deviation: Alarm cycle will be terminated

2. When the cycle continues the people from the ["Internal Group"](#) (see ["Contact List \(alarm\)" on page 105](#)) are called sequentially. To learn what you have to do when you receive an alarm call, please see ["Voice Box System" on page 69](#).

Acknowledgement: Alarm calls stopped. When the person who has assumed responsibility for the system (by acknowledging the alarm call) switches the system on site to „OFF“ mode, a confirmation fax will be sent to all alarm fax recipients to show that the magnet system is under control.

3. When no acknowledgement takes place the ["External Group"](#) is called sequentially.

Acknowledgement: Alarm calls stopped. When the person who has assumed responsibility for the system (by acknowledging the alarm call) switches the system on site to „OFF“ mode, a confirmation fax will be sent to all alarm fax recipients to show that the magnet system is under control.

4. When the fax group is enabled, a fax will be sent to the entire ["Fax Group"](#).
5. When this option is enabled, an e-mail will be sent to the entire ["E-mail Group"](#).

9.4 Alarm Groups

9.4.1 Internal Group

Only company internal phone numbers should be assigned to the „Internal Group“. Typically, during the week, the likelihood of reaching someone in the „Internal Group“ is high so a response to the alarm should be very fast. Depending of the configuration it may need more than one loop through the „Internal Group“ before anyone acknowledges the alarm call using the „Confirmation code“. (see also "[Alarm Groups](#)" on page 81).

9.4.2 External Group

The „External Group“ list normally stores the private telephone numbers or cell phone numbers for the individuals responsible for the system. If no one from the internal group acknowledges the alarm, the system will start calling all the people in the „External Group“.

9.4.3 Fax Group

When the fax group is enabled, the system will send an alarm fax to all phone numbers in the „Fax Group“ during the alarm sequence.

When the person who has assumed responsibility for the system (by acknowledging the alarm call) switches the system on site to „OFF“ mode, a confirming fax will be sent to all alarm fax recipients to show that the magnet system is under control.

9.4.4 E-mail Group

This group is optional. When this option is enabled the system will send an e-mail to the E-mail Group.

For information on setting up e-mail for notification, see "[E-mail Setup](#)" on page 103.

9.5 Stopping the Alarm Sequence

To stop an alarm sequence on site, switch the system to „OFF“ mode. Once the problem has been fixed, switch the system to „Monitor & Alarm“ mode.



The behavior of the system in case of an alarm is dependent on the settings.

The behavior described above is the case of the default settings (delivery state).

10 Voice Box System

The voice box system is the telephone interface used for an alarm sequence or for requesting a remote status report.

To control the voice box system a standard Dual-Tone Multi-Frequency (DTMF) telephone (also called touch tone phone) is used. When the system requests an input for the voice box system, this is made by pressing the corresponding button on the DTMF phone.

The voice box system is a spoken menu of sorts. When connected with the system, the user will be asked to press a corresponding number button on the touch tone telephone in response to the system message or to select an option.

10.1 Alarm Call from the BMPC/2

When an alarm sequence is activated, the voice box system calls all the telephone numbers on the internal and the external phone list (also see ["Contact List" on page 80](#)) until the alarm is confirmed.

Voice Box System Message	Response Required	Note
A salutation, followed by a request to press the star button on your touch tone telephone.	Press the star button on your touch tone phone.	This message will be repeated for up to 120 seconds. If you do not react during this time or if you hang-up the phone, the next phone number from the contact list will be called.
The system status message with a detailed problem description and request for authorization code.	Type in your authorization code , then press the star button (see "Password & Codes" on page 87).	Enter the numbers slowly (e.g. 1 second delay between the consecutive numbers), so that the voice box system can recognize the code.
Message „You are now responsible for the system“.	If the code is not recognized the authorization code must be entered a second time.	If this also fails, the alarm call will be aborted, letting you know there has been a communication problem and the next telephone number on the contact list then will be called.

Table 10.1 Responding to an Alarm Call

When you enter the correct code and take over responsibility for the care of the system, the alarm sequence is stopped by the voice box system. The user can then request a report fax or e-mail through the mail menu (see ["Voice Box Menu" on page 70](#)).

If no one from the list confirms the alarm the first time, the voice box system will repeat

trying to call the until a person is found that enters the correct authorization code.

The number of repetitions that the system will perform can be configured. For details on the alarm cycle refer to the section "[Alarm System](#)" on page 65.

10.2 Remote Status Request

It is possible to request a status report at any time from any place in the world via a touch-tone phone. To do so:

1. Dial the telephone number of the BMPC/2 modem.
2. Wait for the message greeting.
3. When queried, press the star button.
4. Enter the requested authorization code (see "[Password & Codes](#)" on page 87).
5. Press the star button.

You should then hear the current status of the BMPC II. The program will then proceed to the voice box menu.

10.2.1 Voice Box Menu

While in the main menu of the voice box system, you can select between four options using the corresponding code:

- Press '0' to leave the system.
- Press '1' to enter the fax menu.
- Press '2' to hear the system status once more.
- Press '9' to enter to the e-mail menu.

10.2.2 Fax Menu

There are 4 options available in the fax menu, accessible by pressing the corresponding code number.

- Press '0' to exit to the main menu.
- Press '1' to request a report fax for the last 24 hours (data log file).
- Press '2' to request a report fax for the last 7 days (data log file).
- Press '3' to request a report fax for a special period (data log file).

For option '3', enter the start and the stop date for the data you want to receive using the date format dd/mm/yy (e.g. for May 11, 2009 enter 110509).

After selecting the period for the fax report, the user will be requested to type in a fax number. There are three options available:

1. You can type in the fax number where you want to receive the status report using the international phone number format (i.e. 49 721 9515149). To finish the input press the star button.

The system will repeat the phone number. Press '1' if the phone number is correct or '0' if it is incorrect. In case of a wrong number you will have the opportunity to reenter the correct number.

The system will then generate an **optimized number**, based on the parameters in "[Phone Line & Modem Settings](#)" on page 102.

2. You can type in a fax number including any „pre-codes“. In this case you will need to know the exact international access code, plus any code to get an outside line. **The system will use the exact number that you enter**, it will not optimize it for your area.

Enter the number using the following format:

<code for outside line if required> <international access code> <area code and local fax number>

For example: #9 011 512 123 4567

The voice box system will repeat the number and you must confirm it.

3. You can use the **default** fax number which is configured in the "[Phone Line & Modem Settings](#)" on page 102. In this case use only the button combination '#*'. The voice box system will repeat the stored number and you must confirm it.

After finishing the data input the voice box system will disconnect the connection and start the fax transmission.

10.2.3 E-Mail Menu

There are 4 options available in the e-mail menu, accessible by pressing the corresponding code number.

- Press '0' to exit to the main menu.
- Press '1' to request a report e-mail for the last 24 hours (data log & event log file).
- Press '2' to request a report e-mail for the last 7 days (data log & event log file).
- Press '3' to request a report e-mail for a special period (data log & event log file).

For option '3', enter the start and the stop date for the data you want to receive using the date format is dd/mm/yy (e.g. for May 11, 2009 enter 110509).

After selecting the period for the e-mail report:

1. Type in a three digit number.
2. The system will repeat the number. Press '1' if the is correct or '0' if it is incorrect. In case of a wrong number you will have an opportunity to reenter the correct number.

After closing the voice box system the system will send the e-mail to a default e-mail address (normally „bmpc-request@bruker.de“).

The subject line of the e-mail will start with '[BmpcEmail#<three digit number>]'. This number is a specific ID (i.e. BRUKER service engineer). This ID is used by BRUKER e-mail server to forward the incoming e-mail to the person which has requested the e-mail.

The data log and event log will be sent as two attached files (text file, comma separated format).

10.2.4 Using the Voice Box

To speed up the process while working with the voice box system it is possible to enter the corresponding codes while the system is still explaining the options.

For example, if you know which option you want, enter the option when the system begins with the text „You are now in the main menu. Press '1' to....“. When you do this the voice box system will skip the rest of the text and proceed directly to the selected option.

Due to the varying quality of phone lines, it is possible that you need to enter the correct data more then once, before the voice box system recognizes it. Do not enter the DTMF data too quickly, rather use short delays (e.g. 1 second) between the button inputs.

When the line quality is very bad it might help to hang-up and establish a new connection to the voice box system.

11 Setup and Diagnostics Tool

The BMPC/2 Setup Tool is used to:

- Download new firmware.
- Recalibrate the temperature sensors for T1 and T2.
- Perform CAN bus diagnostics.

To use the setup tool, first stop and close the BMPC/2 control program.

11.1 Starting the Setup Tool

If you are logged in as Windows Administrator you can start the setup tool by clicking the corresponding setup tool icon. If you are logged in as a standard Windows user use the Windows XP *Start* feature to start the program.

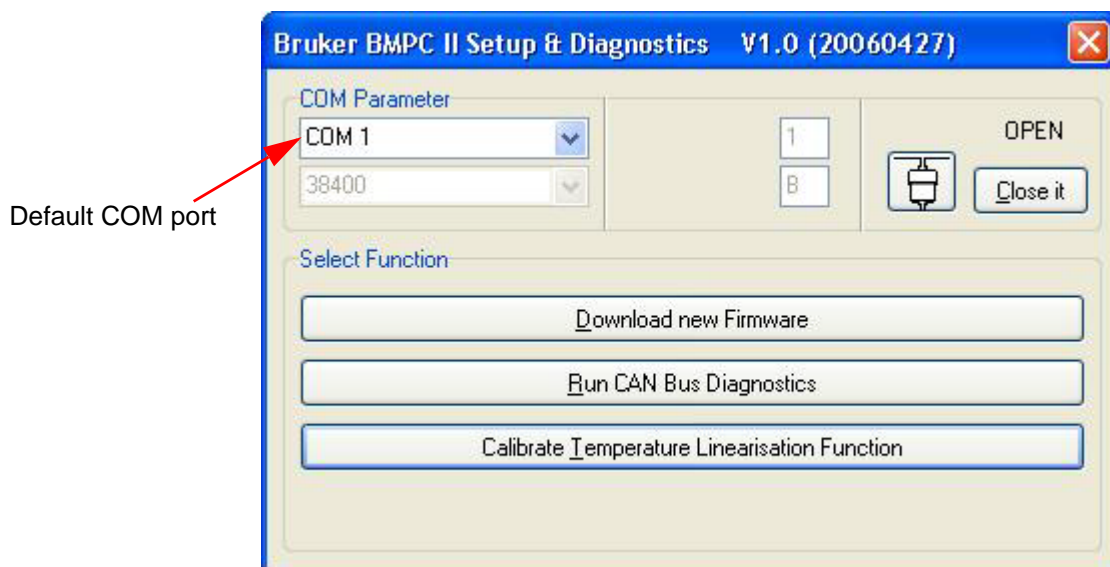

Figure 11.1: Setup Tool Start Window

11.2 Downloading New Firmware

This function is used to download a new firmware version simultaneously to the BMPC/2 Control Unit and Wiring Box. The firmware download typically requires around 10-12 minutes.

i Notice: Take care when exchanging the Control Unit or Wiring Box, that the same firmware is on the Control Unit and the Wiring Box. The firmware on both units must be the same!

Normally a BMPC/2 Control Software version works only with a corresponding firmware version in the Control Unit and the Wiring Box. For example, the firmware „BMPCAPPL_100201v5.0.H86 has the release date of February 1, 2010, and Version 5.0. When the BMPC/2 is started, it checks if the version V5.0 corresponds to the internal stored version Vx.y. If the major release value („x“) is equal, the software will start, otherwise a warning window will appear and the software will not start.

After selecting this function, browse for the new firmware file which should be new in the directory:

c:\program files\bruker\bmpc2\Firmware\bmpc*.h86

After selecting the current version, you can start the download by pressing the button *Start Download*.

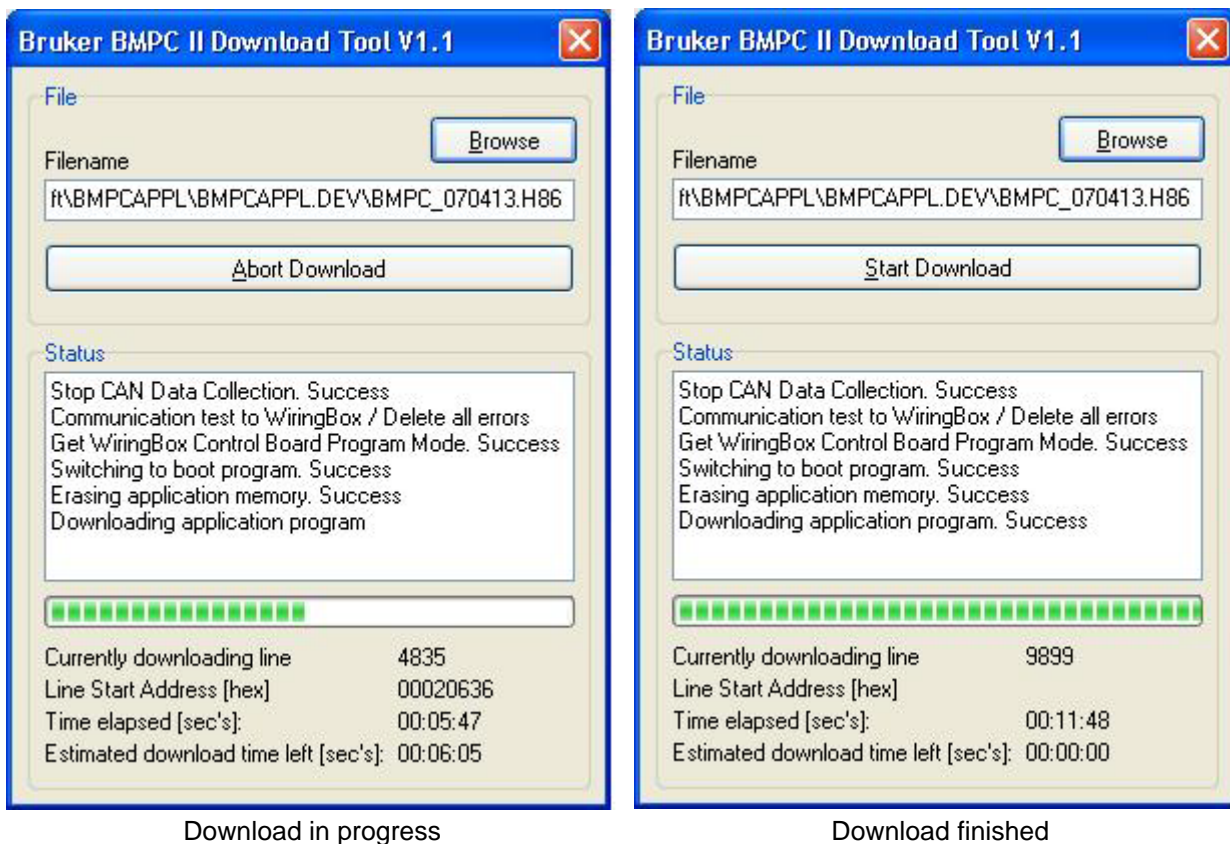

Figure 11.2: Setup Tool - Download

When a download process terminates without finishing the download, an error message is displayed. In this case you will need to try again. Should the download fail a second time, call Bruker service for assistance.

11.3 Run CAN Bus Diagnostic

If there are functional problems with the CAN bus, you can use the CAN Bus Diagnostics to search for the problem. After starting this function, all CAN bus functions will be checked to see if they operate correctly.



Figure 11.3: Setup Tool - Can Bus Diagnostic

In the above example a communication problem with the flow meter was detected.

If the test fails, read the section ["When the Value of a Parameter is Displayed as NAN" on page 125](#) for tips on handling this problem. If this does not help contact Bruker service for assistance.

11.4 Calibrate Temperature Linearization Function

This function is used to recalibrate the temperature sensors for T1 or T2. To use this function you need both calibration connectors BMPC/2 T1/T2 Calibration Connector High (P/N HZ13703) and BMPC/2 T1/T2 Calibration Connector Low (P/N HZ13704).

Start the calibration by selecting the Calibrate Temperature Linearization Function.

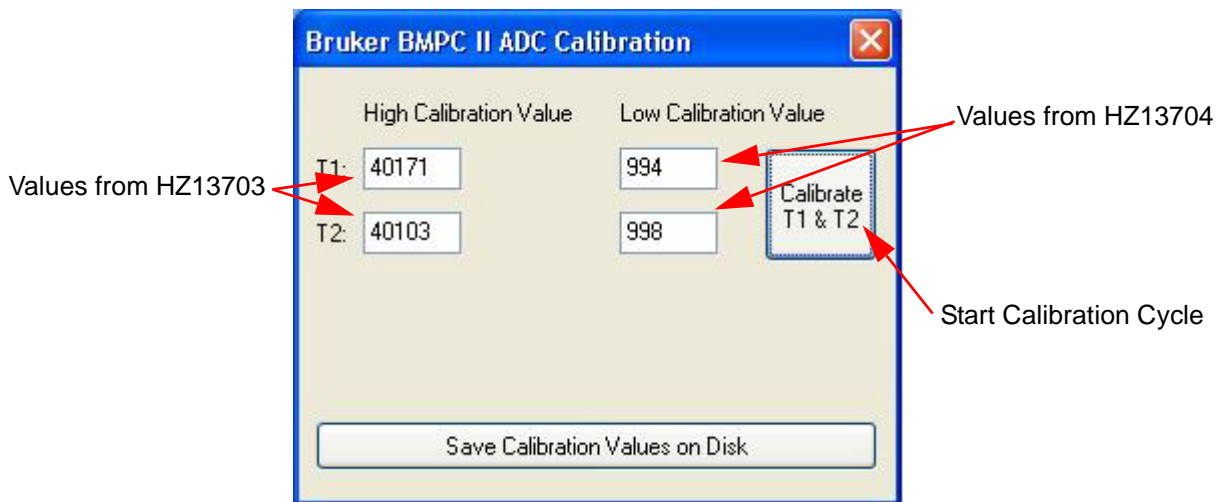

Figure 11.4: Setup Tool - Calibrate Temperature

1. First input the values of both calibration connectors in the fields shown in the figure above and press the **Save Calibration Values on Disk** button. These values are printed on a small label on the calibration connector. Once entered the values will be stored on the hard drive for future use.
2. Press the button *Calibrate T1 & T2* and follow the instructions that will be displayed.

i Store the calibration connectors very carefully. Without these parts it is not possible to recalibrate the BMPC/2.

12 Configuration (Administrator)

The configuration of the BMPC/2 is limited to the Administrator and Bruker service personnel.

For optimal operation of the BMPC/2 several system parameters must be adjusted. In addition, some local adjustments are needed concerning the telephone system that is used and the error alerts that are required.

During installation all settings for the magnet system are adjusted using the "[Magnet Setup Wizard](#)". Likewise, the laboratory environment settings are adjusted using the "[Customer Setup Wizard](#)".

Changes to an existing configuration can be made in the "[The Options Menu](#)".

12.1 Magnet Setup Wizard

The Magnet Setup Wizard is used to change the magnet dependent data, including all limit adjustments and adjustments for the magnet heater.

Important: The Magnet Setup Wizard will overwrite the previous setup!

To access the Magnet Setup Wizard select *Tools - Magnet Setup* from the main menu. Press the **Next** button to the next step.

Select the magnet type

Enter the data for the temperature sensors T1 + T2

These values will be automatically calculated

	Normal	Warning	Alarm
VT 1 (T1)	16120	15306	14818
VT 2 (T2)	20544	19507	18884
P1 low	3	2	1
P1 high	20	25	30
Flow	115	80	70

Figure 12.1: Magnet Setup Step 1

Configuration (Administrator)

1. Select your magnet from the pull-down list.
2. Enter the temperature measuring resistance for T1 and T2. The limit data is then calculated automatically.
3. Press the **Next** button to continue to the next magnet setup step.

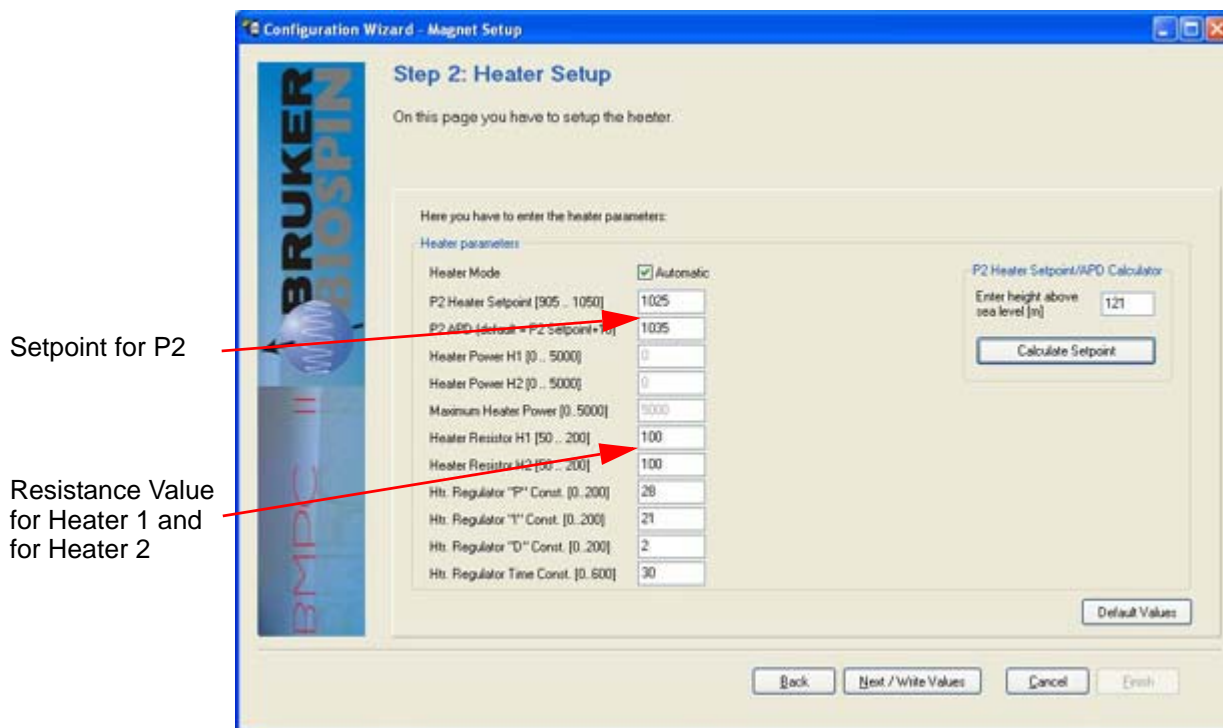

Figure 12.2: Magnet Setup Step 2

4. Enter the setpoint for pressure value P2. The correct setting depends on the height above sea level where the magnet is installed.

Alternatively, to calculate the P2 heater setpoint, enter the height value in the field provided press the **Calculate Setpoint** button.

The setpoint is the pressure that is to be reached with the help of the heating regulator.

The P2 APD value will be calculated automatically.

5. Enter the resistance values for the two heating resistors. These are usually 100 Ohms. More detailed information can be found in the magnet manual.
6. Press the **Next/Write Values** button to assume the configuration data.
7. When prompted, confirm that the configuration is correct by pressing **Yes**, or **No** if you need to revise the data.

12.2 Customer Setup Wizard

The telephone system, modem adjustments and alarm system for the BMPC/2 can be configured using the Customer Setup Wizard.

Important: The Customer Setup Wizard will overwrite the previous setup!

To start the wizard select *Tools - Customer Setup* from the main menu.

Press the **Next** button to advance to the first step, Phone Line and Modem Settings.

12.2.1 Phone Line & Modem Setting

Configuration Wizard - Customer Setup

Phone line & modem settings

In an alarm condition the system will make phone call or send faxes to different people. For a proper working of the alarm system it is necessary to enter the following data accurately.

Phone line

To use the alarm function, the system (modem) must be connected to a phone line. Please enter the phone number of the phone line you are using. It is recommended to enter the phone number in the international form which begins with the code of your country (i.e. 49 721 5161-0 or 1 528 123 4567). For a better appearance it is allowed to use spaces or "-" to separate the different parts of the phone number. If you are connected to a phone system (PABX), please do not enter any pre-codes which are normally used to get an international line or to get an outside line. This phone number is although used to proceed the phone line test.

Phone number of the phone line: 49 721 5161-007

Parameters, Pre-Codes

Please enter the following codes you need, to use the phone line to which the system is connected.

- My phone line is a direct line
 My phone line is connected to a phone system (PABX)
To get an outside line, I must dial the following code (i.e. "9", "0"): 0
- To get an international line I must dial (i.e. "011", "00"): 00
- The country/region code for my site is (i.e. "49" = Germany, "1" = USA, etc.): 49
- The city/area code for my site is: (0) 721
 For calls within my city I can omit the city/area code
 For calls within my city I have to dial the city/area code.

Back Next Cancel Finish

Figure 12.3: Customer Setup - Phone Line & Modem Settings

Enter the requested information and confirm it by pressing **Next**. This will advance you to the next step, the Contacts List setup.

12.2.2 Contact List

In this step data for the individuals that will be called in case of an emergency will be registered. Enter the following data of at least 4 individuals responsible for the magnet system in case of a malfunction:

1. Name.
2. In-house work telephone number (preceded with a „#“ symbol).
3. External telephone number in international format.
4. When available, the E-mail address for each of the responsible individuals.

At least 4 individual external telephone numbers and 2 individual internal telephone numbers are required. Cell phone numbers may be entered for the internal telephone numbers.

Resp. Persons #	Name, Prenom	Phone number (internal group)	Phone number (external group)	Email
1.	Klaus Mustermann	#123	+49 721 5161 123	
2.	Petra Musterfrau	#234	+49 721 5161 234	
3.	Klaus Testmann	#345	+49 721 5161 345	
4.	Elke Testrau	#456	+49 721 5161 456	

Fax #	Name, Prenom	Fax number
1.	BRUKER BioSpin, Magnet, GER	49 721 5161 773
2.		

Figure 12.4: Customer Setup - Contacts List (alarm)

When you desire that an additional fax (in addition to Bruker Germany) be sent in case of an alarm, enter the fax number in the space provided.

i The four responsible individuals should be able to carry out the necessary steps required to stabilize the system in the event of a malfunction. Routine training of these individuals is highly recommended!

Once you have entered the required data, press the **Next** button to precede to the next step, Alarm Groups setup.

12.2.3 Alarm Groups

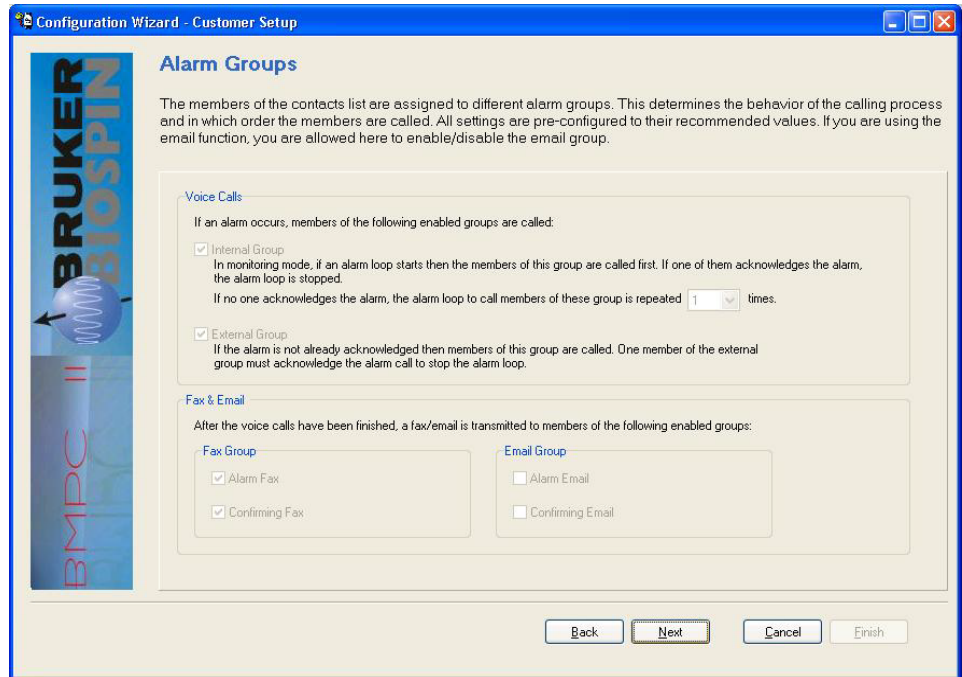

Figure 12.5: Customer Setup - Alarm Groups

The Alarm Groups have already been pre-configured. Press the **Next** button to continue to the Fax Setup.

12.2.4 Fax Setup - Fax ID

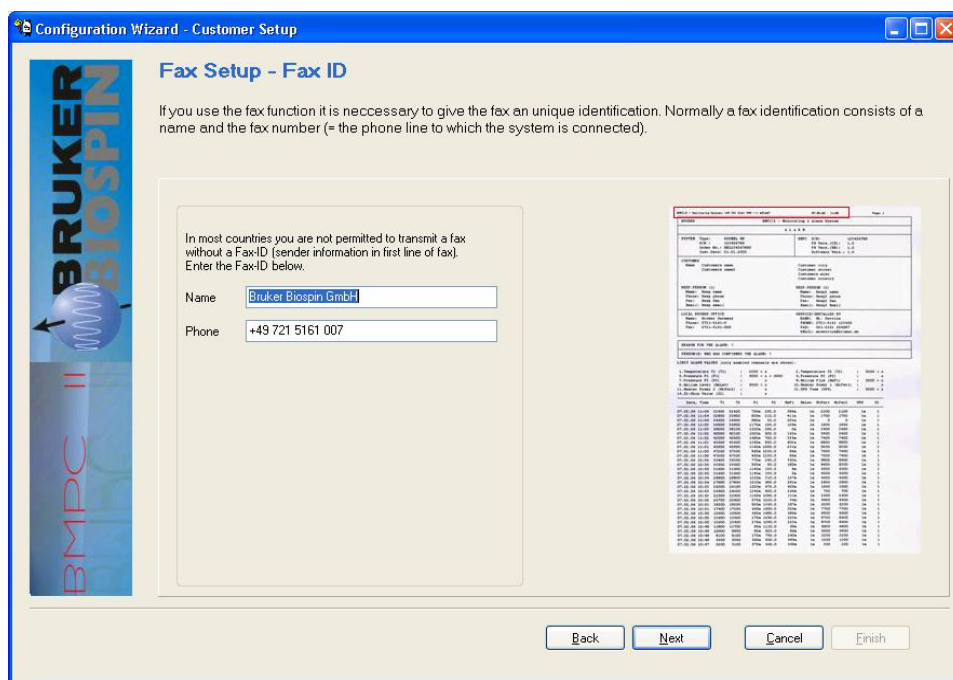

Figure 12.6: Customer Setup - Fax Setup - Fax ID

1. Enter the name of your company or institution.
2. Enter the appropriate fax number for the sender.

These entries serve for the identification of the fax and do not influence the fax dispatch. Some countries require that this data be imprinted on each fax that is dispatched. This data appears on the fax as shown in the red marked area of [Figure 12.6](#):

3. Press the **Next** button to continue to the System Fax Header setup.

12.2.5 Fax Setup - Fax Header (System)

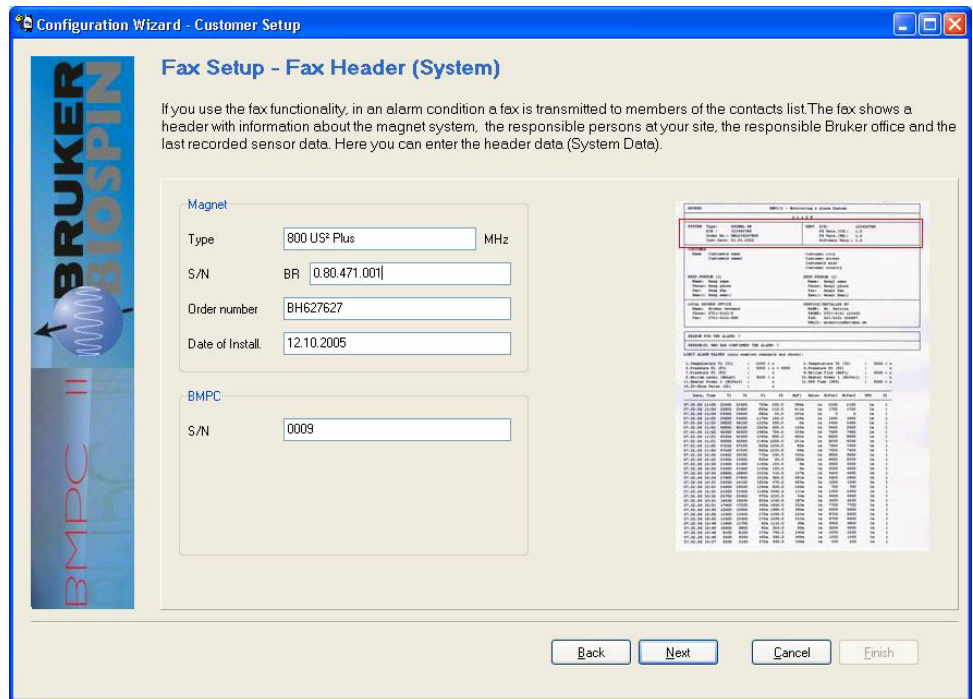

Figure 12.7: Customer Setup - Fax Setup - Fax Header

In this window you will be required to enter all the data related to your magnet system. When an alarm or status fax is sent this information will appear in the header of the fax, as indicated in the red marked area of [Figure 12.7](#).

When you have entered the required information press the **Next** button to continue to the Customer Fax setup.

12.2.6 Fax Setup - Fax Header (Customer)

Configuration Wizard - Customer Setup

Fax Setup - Fax Header (Customer)

If you use the fax functionality, in an alarm condition a fax is transmitted to members of the contacts list. The fax shows a header with information about the magnet system, the responsible persons at your site, the responsible Bruker office and the last recorded sensor data. Here you can enter the header data (Customer Data).

Customer Data

Name: Firmenname
Location: Firmenstrasse
Firmenpostleitzahl Firmenort
Firmenland

Responsible Persons

Responsible Person #1
Name: Klaus Mustermann
Phone: +49 721 5161 111
Fax: +49 721 5161 001
Email: [empty]

Responsible Person #2
Name: Petra Musterfrau
Phone: +49 721 5161 222
Fax: +49 721 5161 001
Email: [empty]

Buttons: Back, Next, Cancel, Finish

Figure 12.8: Customer Setup - Fax Setup - Fax Header (Customer)

1. Enter the appropriate data for your company or institution in the Customer Data area of the setup form.
2. Enter the individuals responsible for the magnet system in the space provided.



In the event of an alarm, Bruker can only provide effective assistance if all the information in the customer data header is valid and current.

The data that is entered in this setup window will appear on the Alarm/Status fax as indicated in the red marked area of [Figure 12.8](#).

3. Press the **Next** button to continue to the Bruker Office Fax setup.

12.2.8 Customer Setup - Summary

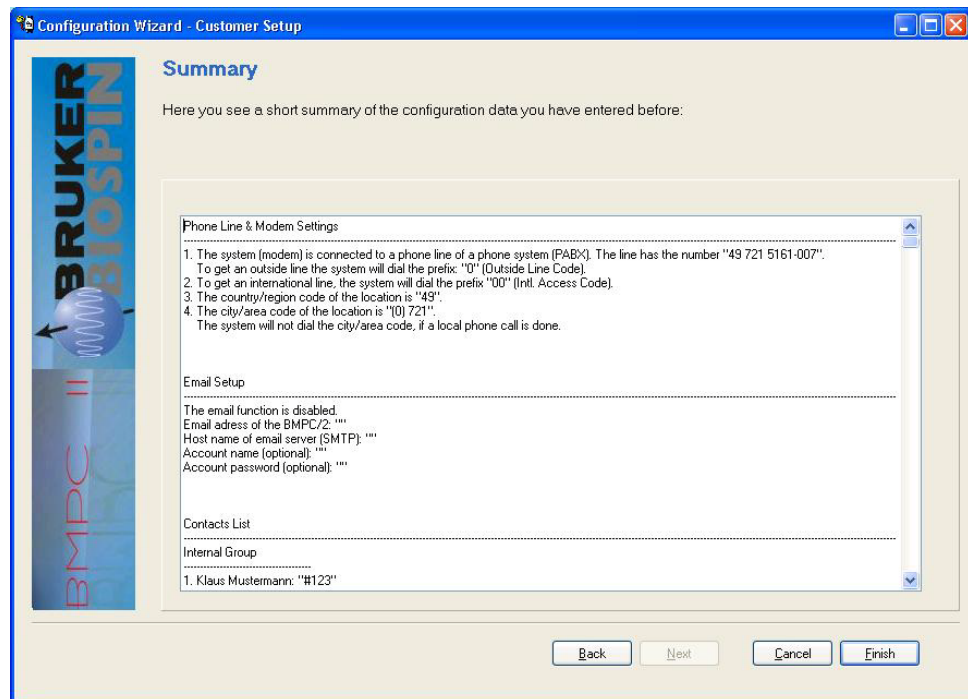

Figure 12.10: Customer Setup - Summary

Verify the information in the summary for accuracy and completeness. If the information is correct press **Finish** to complete the setup, or **Back** to correct any setup data.

12.3 The Options Menu

The Options Menu allows you to make basic adjustments to the BMPC/2. The adjustments that are allowed are based on the login level. You need to login as an administrator to make changes using the Tools - Options menu.

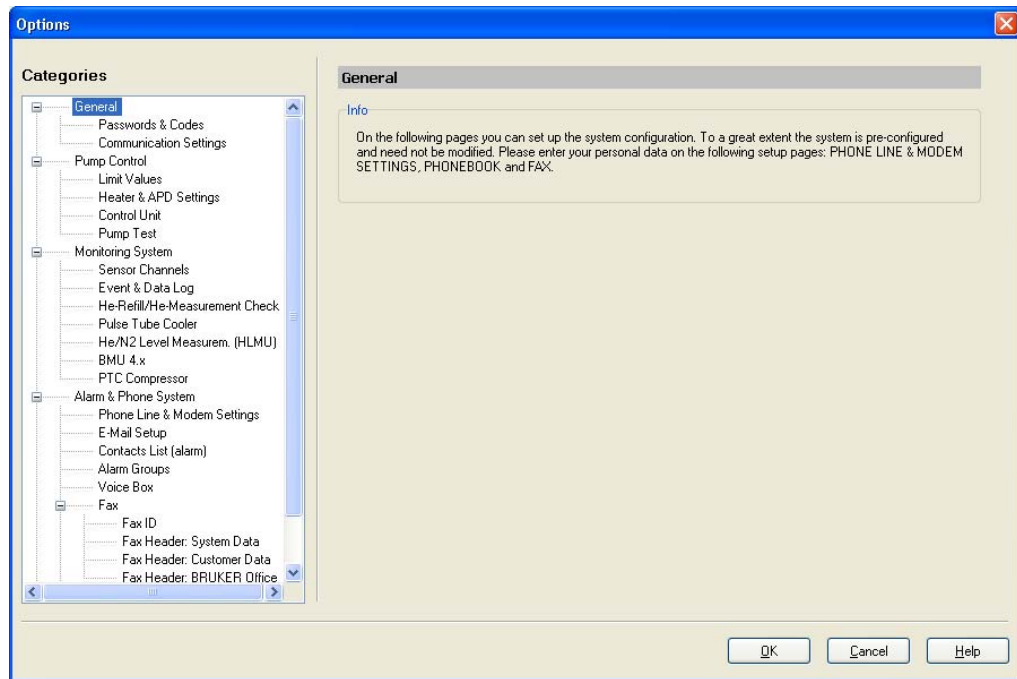

Figure 12.11: Tools - Options Menu

12.3.1 Options - General

12.3.1.1 Password & Codes

The Passwords & Codes option allows you to assign passwords to access different rights of access. You can also change the codes necessary for controlling the system voice box. Changing a password is only possible if you are logged in as administrator.

The codes shown in the figure below are the default passwords which are valid after a new software installation. Only the passwords that are relevant for the current login level are displayed in the setup window. In this example the user was logged in as administrator.

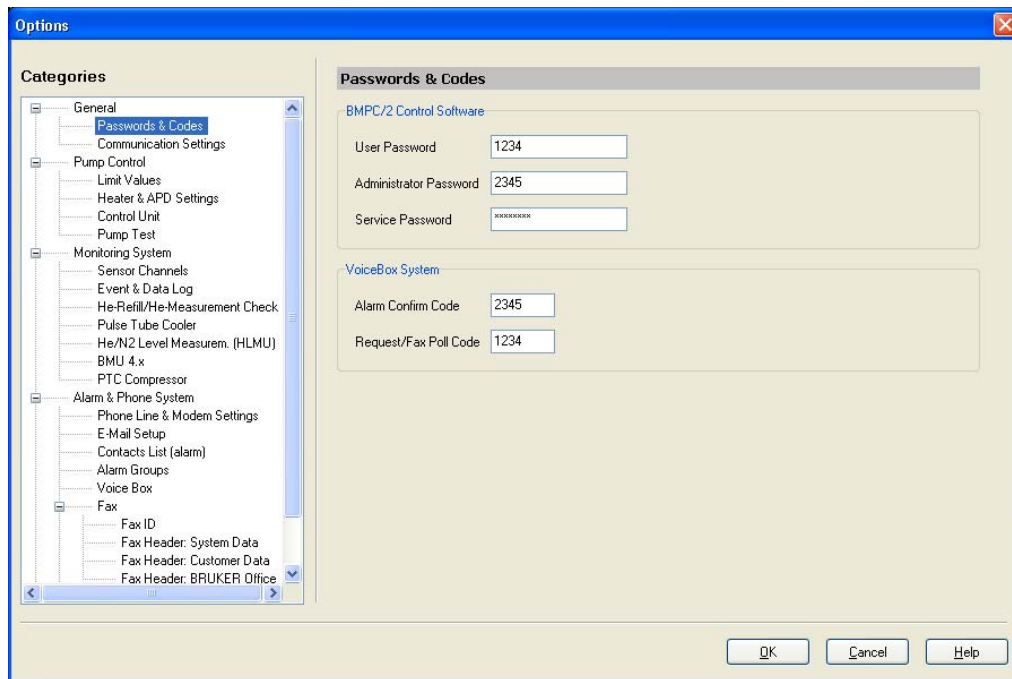

Figure 12.12: Tools - Options - Passwords & Codes

User Password

When you are logged in as a normal user you are able to control the BMPC/2. You are also allowed to change between the different displays and to select between the operating modes.

Administrator Password

In addition to the user functions, the Administrator can also change the configuration of the BMPC/2.

Service Password

The service mode is restricted to Bruker Service personnel. The service access password for your system is shadowed out and cannot be modified.

Alarm Confirm Code

The Alarm Confirm Code is needed during an alarm cycle to control the voice box system. Entering this code using a DTMF telephone will stop the alarm cycle.

Request Fax/Poll Code

This code is needed if you want to poll the current status of the BMPC/2 or if requesting a status fax, using a DTMF telephone.

Press the **OK** button in the main Options window to confirm the changes when you finished.

After a software update the codes you have changed are still valid. After a complete software reinstallation, the passwords are changed back to the defaults.

i If you have changed a password which was used by another person, do not forget to inform them about the changes!

12.3.1.2 Communication Settings

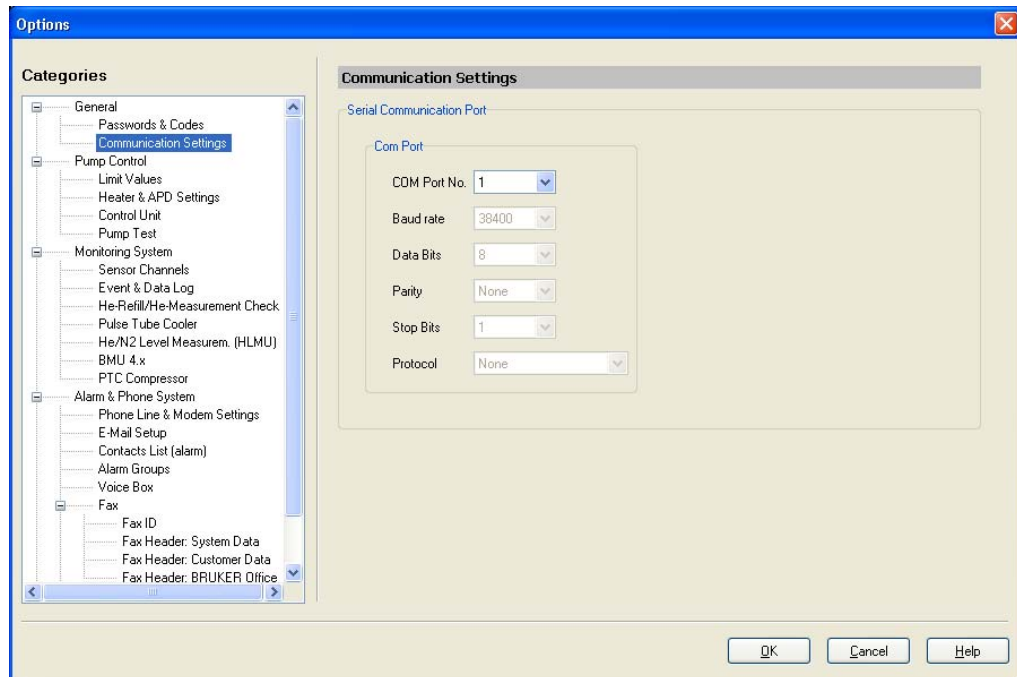

Figure 12.13: Tools - Options - Communication Settings

The default value for the Com Port is „1“. The other communication parameters are only displayed for information purposes, they cannot be changed.

12.3.2 Pump Control

12.3.2.1 Limit Values

The Pump Control option setup window allows you to set the various limit values for site conditions. Appropriate values are normally already assigned during the magnet setup wizard, thus an adjustment is only needed in rare cases.

NOTICE

Changing the limit values

Changing the limit values may result in the system reacting differently than expected and may delay the triggering of alarms.

- Changes should only be made by experienced personnel that understand the implications of these changes.

When you want to change a limit value, first select the parameter, then enter the new upper and lower limit values. To transfer the new values to the BMPC/2 press the Write Values button.

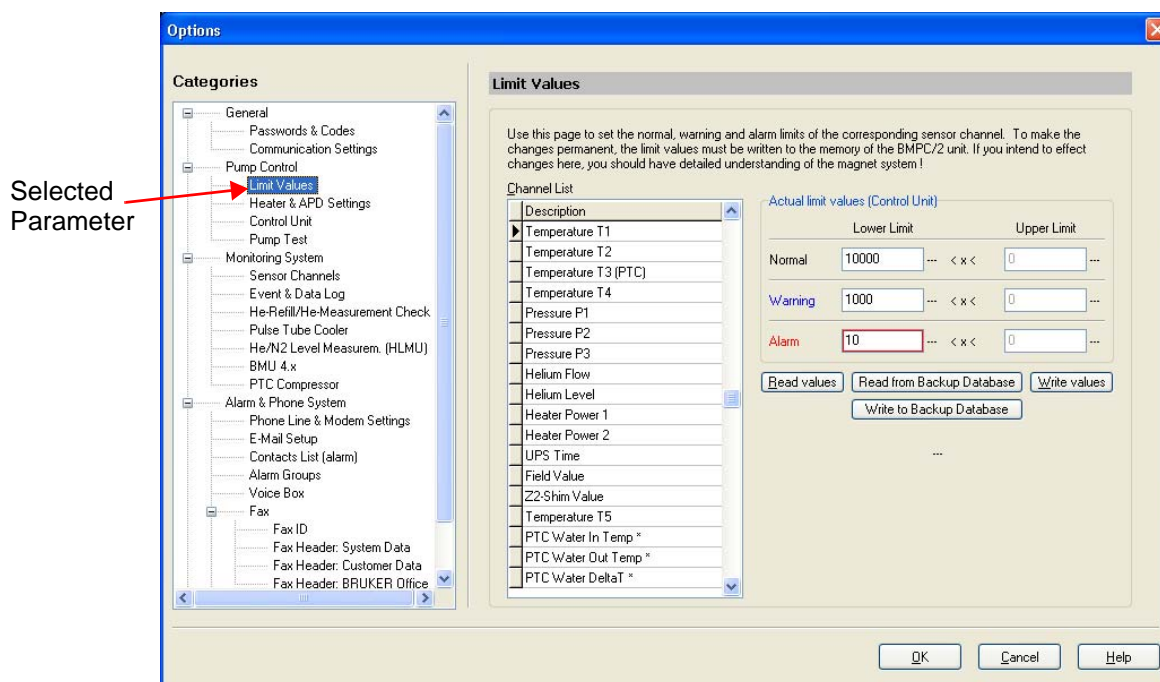

Figure 12.14: Tools - Options - Limit Values

- **Read Values:** Pressing this button will result in the display of the current values from the BMPC/2. This is useful when you have changed the values, but not written them to the unit and want to reload the current values.
- **Read from Backup Database:** With this button you can read the values backwards from the backup database. This is useful if you want to reuse a former configuration.
- **Write Values:** Pressing this button will write the current field values to the control unit.
Warning: This will overwrite the current values saved in the control unit memory.

Write to Backup Database: When you press this button you can save the current field values in the database of the BMPC/2 control program.

i Changes to the limit values will first take effect when you press the Write Values button. Once you are certain that the values are suitable you can add them later to the backup database by pressing the Write to Backup Database button.

12.3.2.2 Heater & APD Settings

In this settings window you can adjust the settings for the magnet heater.

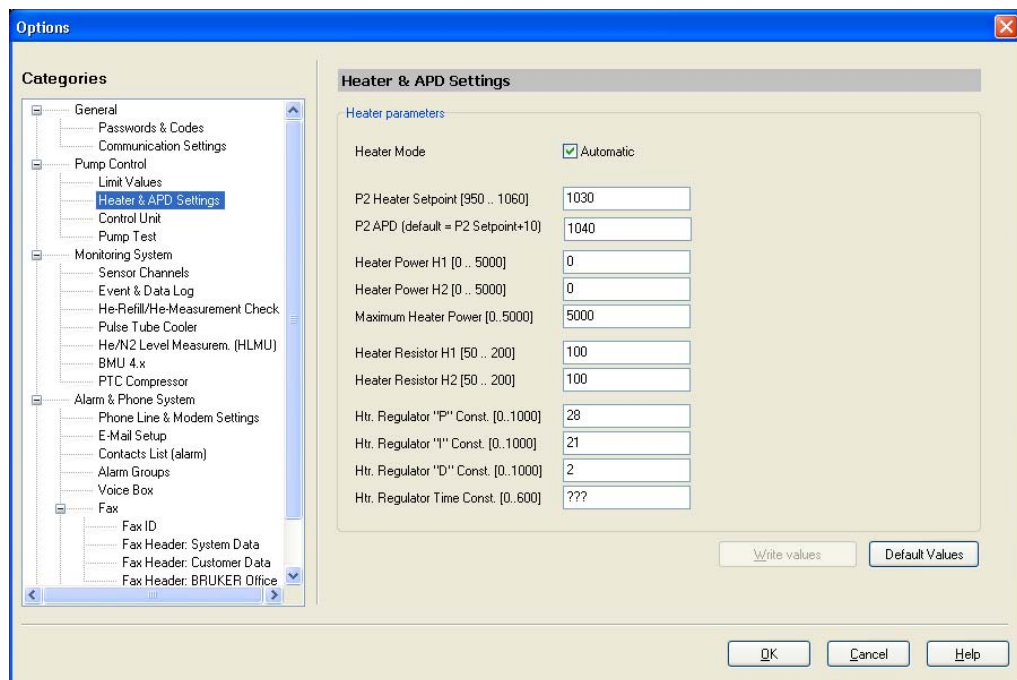

Figure 12.15: Tools - Options - Heater & APD Setting

These values are normally entered during the installation and in most cases do not need to be modified.

- **Heater Mode:** It is possible to operate in automatic or manual heater mode. As default Automatic mode is selected. In automatic mode, internal regulation ensures that the P2 pressure remains constant in the magnet dewar, based on the values entered. In manual mode (Automatic must be deselected) the unit will be heated using a constant heater power.
- **P2 Heater Set Point:** This is the target value of the automatic heater control. This value must be at least 1 mBar lower as the P2 APD target value.
- **P2 APD:** This is the target value for the P2 absolute pressure regulator. The absolute pressure regulator ensures that the magnet remains at a constant pressure even when working in the over pressure range.
- **Heater Power H1:** This field allows you to enter the H1 heater power value for heater operation in manual mode.
- **Heater Power H2:** This field allows you to enter the H2 heater power value for heater operation in manual mode.
- **Heater Resistor H1:** This field is used to enter the resistance value for the H1 heater.
- **Heater Resistor H2:** This field is used to enter the resistance value for the H2 heater.

Press the **Write Values** button to write the values to the control unit.

CAUTION



Heater and APD Settings

Changes in these adjustments may cause low pressure in the magnet dewar. This could lead to a dangerous icing of the magnet.

- ▶ Changes should only be made by experienced personnel that understand the implications of these changes.

12.3.2.3 Control Unit

This option window allows you to read the current firmware version from the BMPC II, and to reset the control unit.

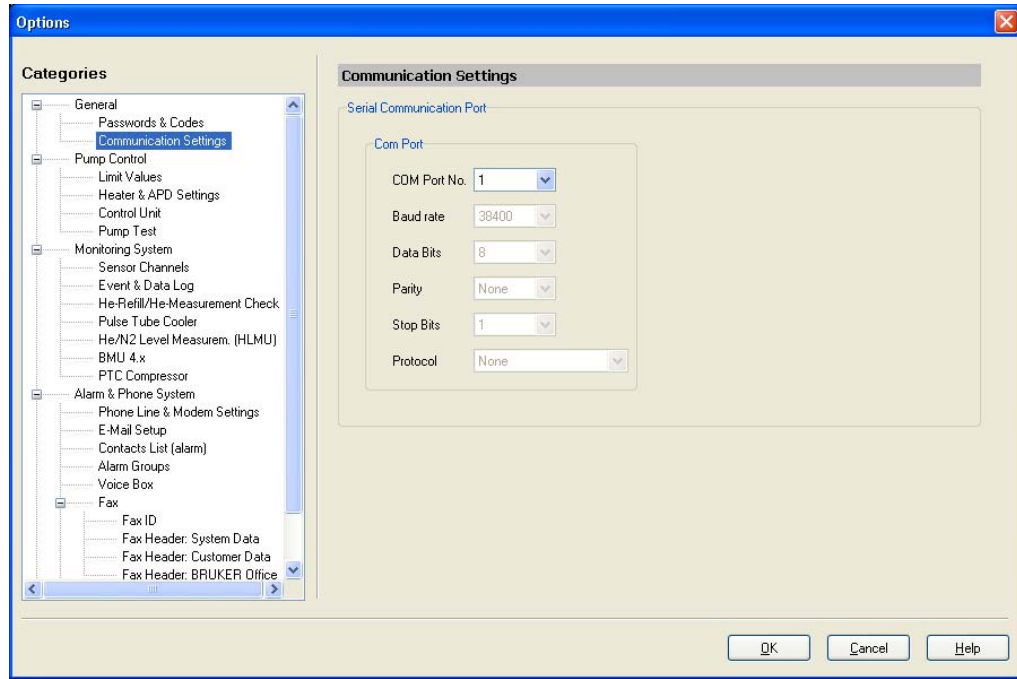

Figure 12.16: Tools - Options - Control Unit

A software reset may be necessary when, during a system start or a firmware download, communication to various sensors does not start correctly.

To reset the control unit press the button and wait until the reset procedure is finished.

12.3.2.4 Pump Test

This option window allows you to adjust the automatic pump test. Please read the section "[Configuring the Automatic Pump Test](#)" on page 61.

12.3.3 Monitoring System

12.3.3.1 Sensor Channels

In this settings window you can configure the effect of the individual sensor channels on the alarms, as well as the representation of the channels in the various display options.

Options

Categories

- General
 - Passwords & Codes
 - Communication Settings
 - Pump Control
 - Limit Values
 - Heater & APD Settings
 - Control Unit
 - Pump Test
 - Monitoring System
 - Sensor Channels**
 - Event & Data Log
 - He-Refill/He-Measurement Check
 - Pulse Tube Cooler
 - He/N2 Level Measur. (HLMU)
 - BMU 4.x
 - PTC Compressor
 - Alarm & Phone System
 - Phone Line & Modem Settings
 - E-Mail Setup
 - Contacts List (Alarm)
 - Alarm Groups
 - Voice Box
 - Fax
 - Fax ID
 - Fax Header: System Data
 - Fax Header: Customer Data
 - Fax Header: BRUKER Office

Sensor Channels

Here you can allocate different switches for each channel. To do this, select a channel and then enable/disable the switches you want to change. In Display Setup you can define in which row of the Present Value Display the selected channel is displayed. It is also possible to determine the default settings (row / column) for the Jumbo & DataLog Displays.

Channel List

Description	Switches
Temperature T1	<input checked="" type="checkbox"/> Channel active. Enable this switch if the channel should be continuously read in Logging or Monitoring Mode.
Temperature T2	<input checked="" type="checkbox"/> Alarm Trigger. Enable this switch if the channel should be able to trigger an alarm call while the system is running in Monitor Mode.
Temperature T3 (PTC)	<input checked="" type="checkbox"/> Switch Alarm Trigger temporarily off if system is in He-Refill mode
Temperature T4	
Pressure P1	
Pressure P2	
Pressure P3	
Helium Flow	
Helium Level	
Heater Power 1	
Heater Power 2	
UPS Time	
Field Value	
Zz Shim Value	
Temperature T5	
PTC Water In Temp *	
PTC Water Out Temp *	

Switches

- Channel active. Enable this switch if the channel should be continuously read in Logging or Monitoring Mode.
- Alarm Trigger. Enable this switch if the channel should be able to trigger an alarm call while the system is running in Monitor Mode.
- Switch Alarm Trigger temporarily off if system is in He-Refill mode

Display setup

The selected channel is displayed in ...

- ... row 1 of the Present Value Display.
- ... column 1 (default) of the Data Log Display.
- ... row 1 (default) of the Jumbo Display.
- ... column 1 on the fax.

(*"0" means, channel is not displayed)

OK Cancel Help

1 Selected Sensor Channel

2 Channel Active

3 Enable/Disable Telephone Alarm

4 Alarm disabled during He-Refill

5 Row in Present Value Display

6 Column in Data Log Display

7 Row in Jumbo Display

8 Column in Alarm/Call Fax

Figure 12.17: Tools - Options - Sensor Channels

- Channel Active: When this option is selected, the data for this channel is updated continuously. When the option is not selected the channel information in the present value display is not updated.
- Alarm Trigger: When this option is selected, the telephone-supported alert will be started when an alarm situation occurs (e.g. When a limit value is exceeded).
- Switch Alarm Trigger: When this option is selected the telephone alerting will be deactivated during the duration of the He-Fill cycle.

In the Field Display Setup you can adjust the position of the selected channel in the Present Value Display, Data Log Display, Jumbo Display as well as the Status/Alarm fax.

When a channel is not to be represented in the corresponding display then position „0“ must be selected for this field.

12.3.3.2 Event & Data Log

In this settings window you can adjust the properties of the Event Log and the Data Log.

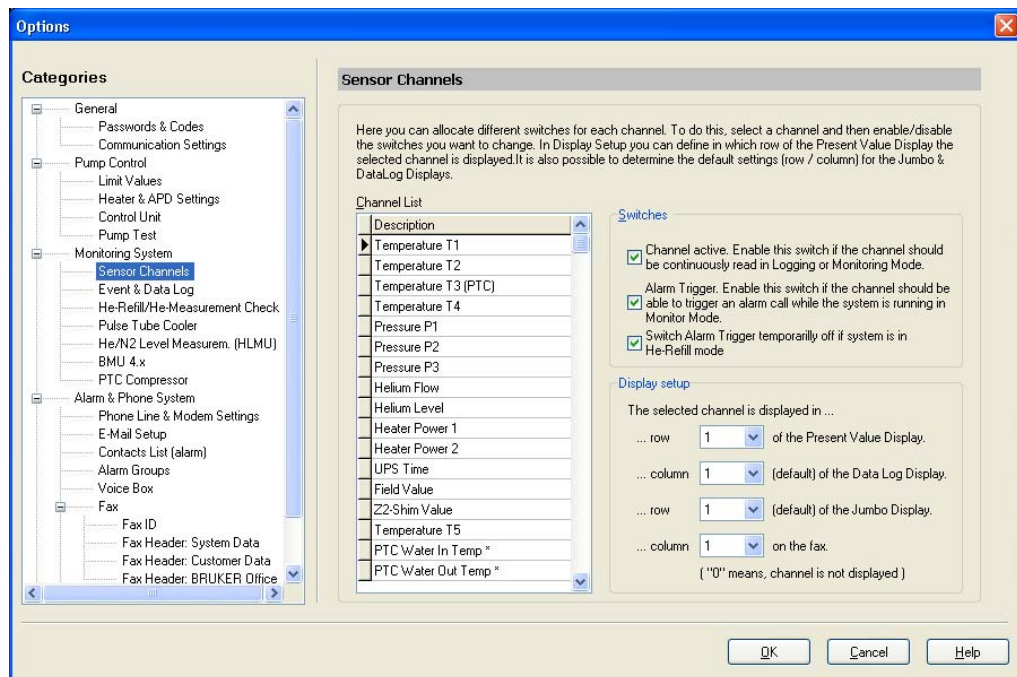

Figure 12.18: Tools - Options - Event & Data Log

1. Event Log (see also "Present Values/Event Display" on page 56)

The following possibilities can be selected:

Unlimited: The log data will be saved until the maximum disk space has been reached.

Number of lines: The maximum number of event log entries can be selected. When the maximum number is reached, the oldest entry will be overwritten.

Number of days: A maximum number of days for which the event log will be stored can be selected. When the maximum number is surpassed, the oldest entry will be overwritten.

2. Data Log (see also "Data Log Display" on page 55)

The same adjustments are available for the Data Log as the Event Log. In addition, there are also several adjustment possibilities for the frequency of entries:

Data Log Interval: Here you can select the interval time for the Data Log. You can choose between 3 minutes and up to 24 hours. If you select 3 minutes, for example, the

complete data set will be written to the data log every 3 minutes. The recommended interval is 6 hours.

Reference Time: The memory cycle is synchronized using this value.

Data Log Interval in Alarm Condition: In alarm condition substantially more data needs to be stored in the log file. Default is 3 minutes. The system switches automatically to a shortened log interval when an emergency occurs.

3. Clear Event / Data Log

In order to delete the entire data or event log file, you must use the Clear Data Log button.

i Note: Using the Clear Data Log button will delete all the data in the file!

It is advisable that you backup the log files on an external storage device (e.g. CD-ROM) before using the Clear Data Log function. To do this you can use the Export Data and Event Log button and/or save the complete log.mdb and log.ldb file from the database directory.

12.3.3.3 He-Refill / He Measurement

This settings window is used to adjust the properties of the helium refill function (refer to the section "[He Fill Mode](#)" on page 59).

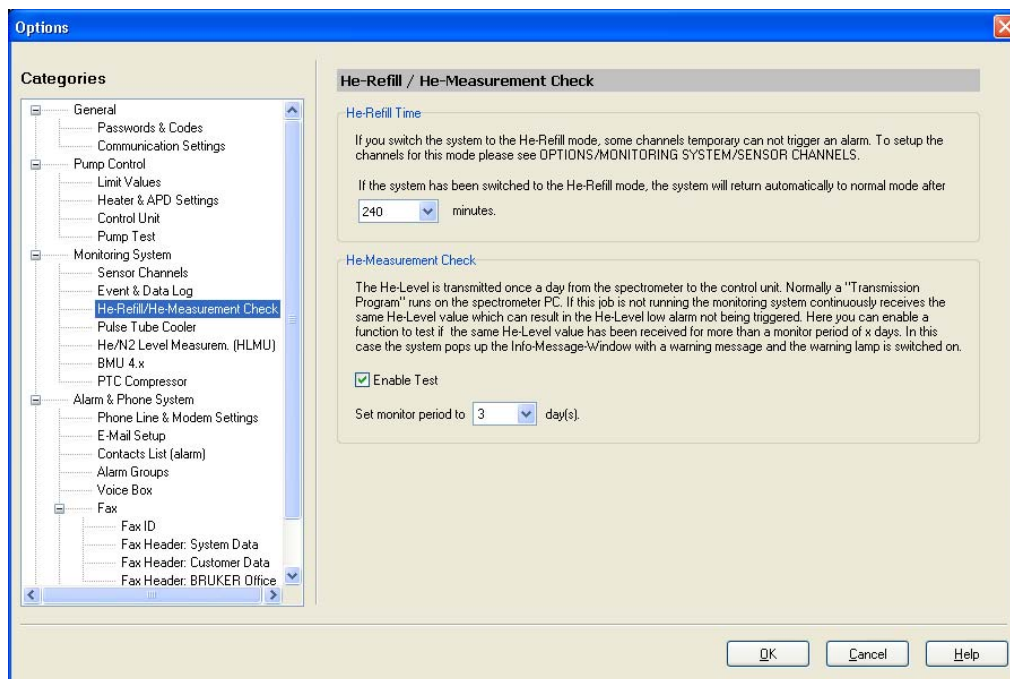

Figure 12.19: Tools - Options - He-Refill / He Measurement

The helium refill time setting allows you to set the amount of time that the selected

alarms will be deactivated during the helium refill. These alarm parameters are set in the Sensor Channels section under the Monitoring System settings (see also "Sensor Channels" on page 94).

In the He Measurement Check window you can activate the helium level monitoring. During the monitoring you can examine whether the helium changes over a preset period of time. This time period can be varied within a range of 1 and 7 days using the field „Set Monitor Period to x days“. When the value of the helium level remains stable for the selected time a warning will be given and a warning light will be activated. With this a missing or incorrectly initialized helium level measurement can be recognized.

12.3.3.4 Pulse Tube Cooler

If your magnet system includes a Pulse Tube Cooler (PTC) the active refrigeration system needs to be monitored.

One important parameter that relates to the operation of the PTC is the heater power. Normally the heater power (Heater Power 1) must be above the set value. If the heater power is below this limit for more than the set time this usual indicates there is a problem.

In this case the system turns on the warning lamp and the software causes the "Info-Dialog" to popup.

To clear the warning and to switch off the warning lamp you must confirm the warning in the "Info-Dialog".

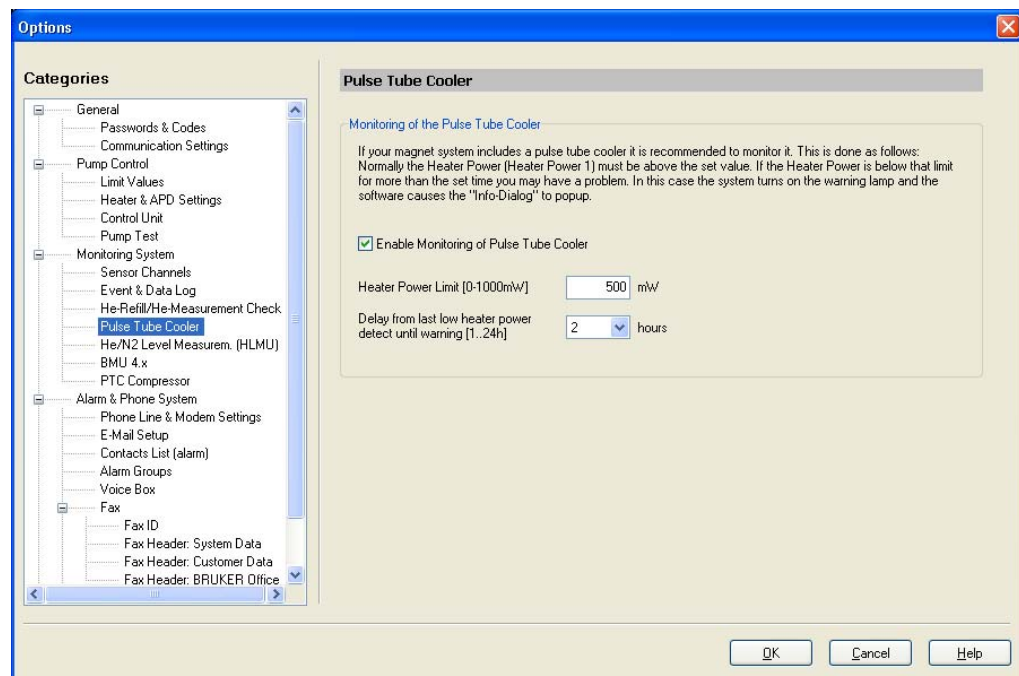

Figure 12.20: Tools - Options - Pulse Tube Cooler

12.3.3.5 He/N2 Measurement with the HLMU

When a BRUKER spectrometer console is not available, you will need a HLMU (Helium/Nitrogen Level Measurement Unit) to measure the helium (or optionally, the nitrogen) level. In this case the BMPC/2 Control software will read the helium level from the HLMU, instead of the BMPC/2 Control Unit, for monitoring.

Before you can use the HLMU to measure the helium level, you have to connect the HLMU to one of the Ethernet ports of the BMPC/2 PC, and setup the Windows network settings for this port.

It is recommended to use the following parameters:

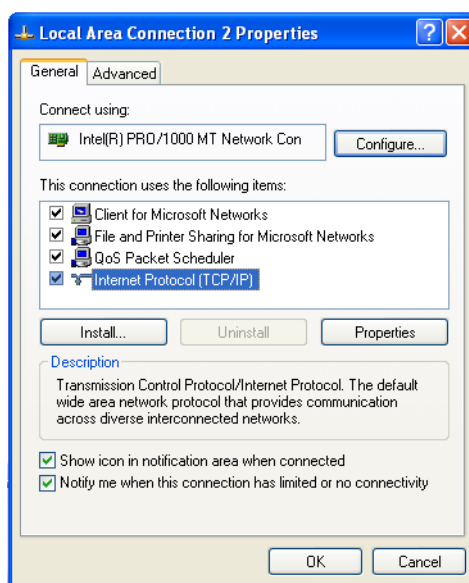

Figure 12.21: Local Area Network Connections

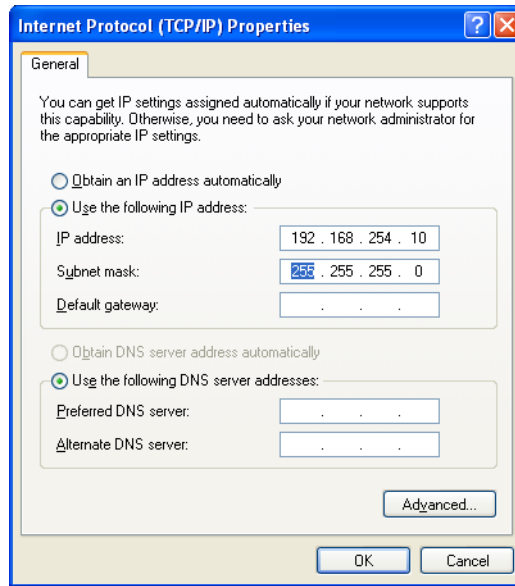

Figure 12.22: Internet Protocol TCP/IP Properties

The default IP address for the HLMU (see the figure above) is: 192.168.254.100.

For details on how to setup and check the settings of the HLMU refer to the HLMU manual.

To use the measurements from the HLMU, you must enable „Monitoring of H2/N2 Level with HLMU“ in the BMPC/2 Options window.

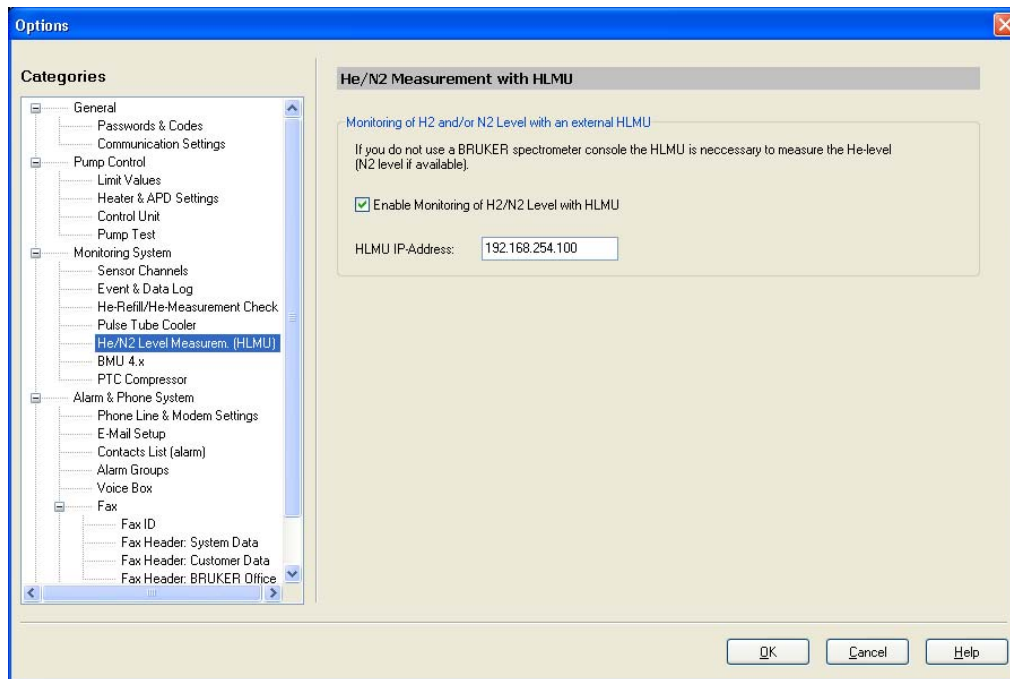

Figure 12.23: Helium/Nitrogen Measurement with the HLMU

In the setup category LIMIT VALUES (see chapter "Limit Values") you will find among others the following two entries used to setup the limit values for use with the HLMU:

- Helium Level (HLMU)
- Nitrogen Level (HLMU)

It is recommended to use the given default parameters (Normal = 70, Warning = 60, Alarm = 50).

Note: If you are using the HLMU for helium (nitrogen) level measurements, the channel "Helium Level" that is normally used, must be disabled (see ["Sensor Channels" on page 94](#)), and the two channels Helium Level (HLMU) and Nitrogen Level (HLMU) must be enabled.

When you now start the Monitoring Mode/Monitoring & Alarm Mode the system will first try to establish a connection to the HLMU. If it fails, the monitoring will not start and an entry will be logged in the Event Log. When the connection is successful, the system will begin continuously reading the level value(s) from the HLMU.

12.3.3.6 BMU 4.x

The Bruker Magnet Monitor Unit BMU4 is used on ultra-high field magnets which are not operated in conjunction with an AVANCE NMR console. The BMU4 is then used to monitor the liquid helium level in the cryostat, the status (on/off) of the compressor(s) for the active regeneration system as well as the temperature of the cooling water for the compressor(s). In addition, the temperature of thermal screens in the cryostat can be monitored.

The BMU4 is connected to the BMPC's industrial PC via the RS232 interface. Typically, COM Port 2 is used. If the compressor status (on/off) is monitored with the BMU4, the parameter "BMU Compressor Status Timeout" denotes the value from which a counter runs down when the compressor is off.

Alarm- and warning values can then be set on this counter to ensure that alarms and warning are issued after the compressor has been off for a certain amount of time. The count-up time is a measure for how slowly the counter runs up when the compressor is operational again.

For additional details on the BMU and its operation, reference is made to the BMU4 Technical Manual.

12.3.3.7 PTC Compressor

Bruker's Aeon NMR magnet systems rely on pulse tube coolers to provide active refrigeration. The pulse tube cooler in an Aeon magnet is supplied with pressurized helium by a compressor, whose correct operation is constantly monitored by the BMPC. The compressor is connected to the industrial PC via an RS232 interface. Typically, COM Port 2 is used. The BMPC can communicate with compressors of two manufacturers, Cryomech, Inc, and Sumitomo Heavy Industries (SHI). To ensure that the correct communication protocol is used, the compressor type has to be selected in the window "Pulse Tube Cooler / Compressor Setting".

Among other parameters, the compressor status (on/off), the cooling water temperature, the compressor capsule temperature and the helium pressure are monitored. Warnings and alarms are issued if these parameters differ sufficiently from their nominal values.

The BMPC can trigger an automatic shut-down of the compressor if certain thresholds for the cooling water temperature are exceeded. In particular, it is possible to set an upper limit on the allowable water inlet temperature, or an upper limit on the allowable temperature difference between the outlet and the inlet. If this temperature difference is too large, the cooling water flow is likely too low.

In Aeon systems, the outlet of the helium pumps is connected to the cryostat to ensure full helium recovery. At high flow rates, the helium pumps in the BMPC expel larger amounts of oil mist and vapor than usual. To avoid that the cryostat is unduly contaminated with oil during periods of high helium flow, the BMPC can automatically control valve 3 as a function of the helium flow rate. The flow rate thresholds at which valve 3 is closed and re-opened can be set in the window "Pulse Tube Cooler / Compressor Setting".

If the compressor status (on/off) is monitored through the compressor's serial interface, the parameter "Compressor Status Timeout" denotes the value from which a counter runs down when the compressor is off. Alarm- and warning values can then be set on this counter to ensure that alarms and warning are issued after the compressor has

been off for a certain amount of time. The count-up time is a measure for how slowly the counter runs up when the compressor is operational again.

12.3.4 Alarm & Phone System

For complete information on using the alarm and telephone system, also read "[Alarm System](#)" on page 65.

12.3.4.1 Phone Line & Modem Settings

In this settings window the most important adjustments for the telephone supported alarm system are configured.

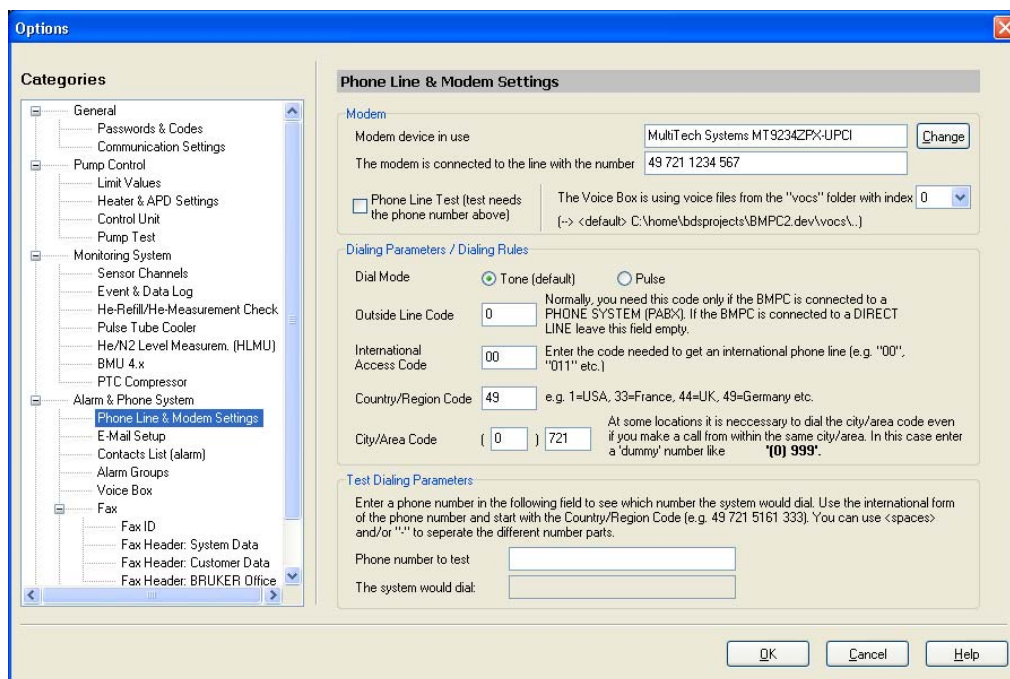

Figure 12.24: Tools - Options - Phone Line & Modem Settings

In order to use a modem with the system the modem information must be entered in the Modem settings area. Normally the system is pre-configured and this step is not necessary, but if this step is required, press **Change** to select the modem device from a list of devices.

Enter the telephone number of the phone to which the system is connected. This number is used for the „Phone Line Test“. When the system is set to „Monitoring & Alarm Mode“ and the „Phone Line Test“ is enabled, the system tries to call itself to test the phone line.

i Notice: On some phone systems it is possible that this test does not work properly. In this case disable the „Phone Line Test“.

The system has an integrated „Voice Box System“ which is used for an alarm sequence, or for requesting a remote status report (see ["Voice Box System" on page 69](#)).

This voice box system uses „Voice files“ for the speech output. This set of files is stored in folders on the hard disk named „vocs“, „vocs1“, and so on.

For future expansion of this system it may be necessary to have more than one set of voice files, for example for other modems, languages etc. To allow for this expansion, it is possible to set an index for the „vocs“ folder used. The default index is „0“ and means that the software uses the voice files stored in the folder „vocs“. When the index is set to „1“ the software will use the files stored in folder „vocs1“, and so on.

Once the modem and telephone number is entered you need to enter the following parameters in the *Dialing Parameters / Dialing Rules* fields:

- Dial Mode: Tone (default) or Pulse
- Outside Line Code. This may be required if the BMPC/2 is connected to, for example, a PABX telephone system.
- The international access code.
- The international country/region code where the unit is located.
- The city/area code where the unit is located.

To see what will be dialed for a given telephone number, simply enter this number in the *Test Dialing Parameters* field. The system shows you the number which would be dialed. If you are entering a number in the preselected area code, then the system should only show the local telephone number as shown in the above example.

12.3.4.2 E-mail Setup

The parameters for the e-mail settings can be supplied by the local system administrator. In some cases it may not be necessary to use a user name and password, whereas the fields will remain blank.

Configuration (Administrator)

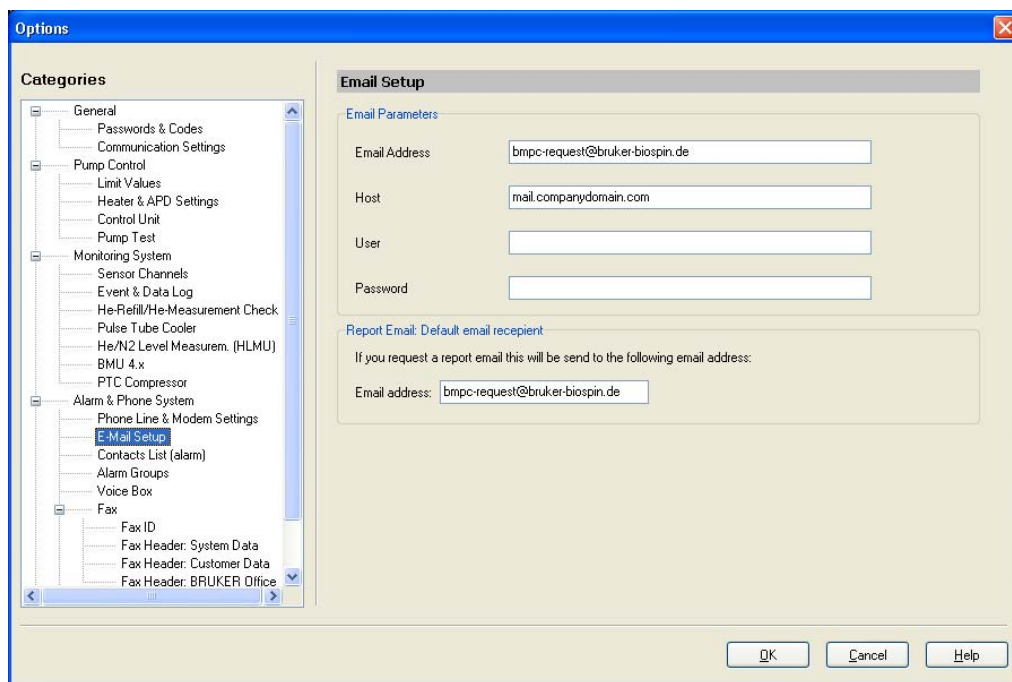

Figure 12.25: Tools - Options - E-Mail Setup

12.3.4.3 Contact List (alarm)

In this window you can make changes to the contact list used for alarms. Press the corresponding button in order to add, edit, delete records or to scroll through the list.

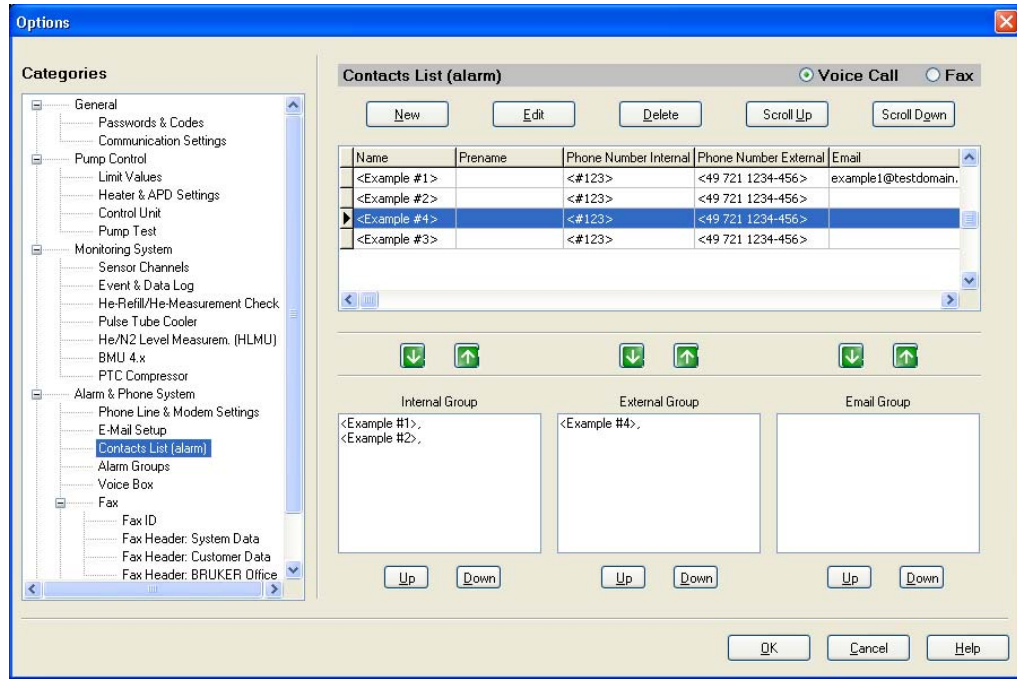

Figure 12.26: Tools - Options - Contact List (alarm)

Through use of the Voice Call and Fax radio buttons, you can determine whether the Voice Call or Fax contact list is displayed.

When you highlight a record from the contact list or one of the groups on the bottom you can add member to or remove members from a notification group using the green arrow buttons.

A description of the various groups and the notification process is found in the section ["Alarm Sequence" on page 66](#).

You can change the sequence within these groups (and therefore the sequence in which they will be contacted) by highlighting the name and using the up and down buttons.

You can also make changes to the groups through the use of Drag & Drop with your mouse.

If you want to add new individuals to the Contact List or you need to change data for an individual on the list, use the functions **New** or **Edit**. Enter or edit the data as shown in [Figure 12.27](#): and press **OK** to accept.

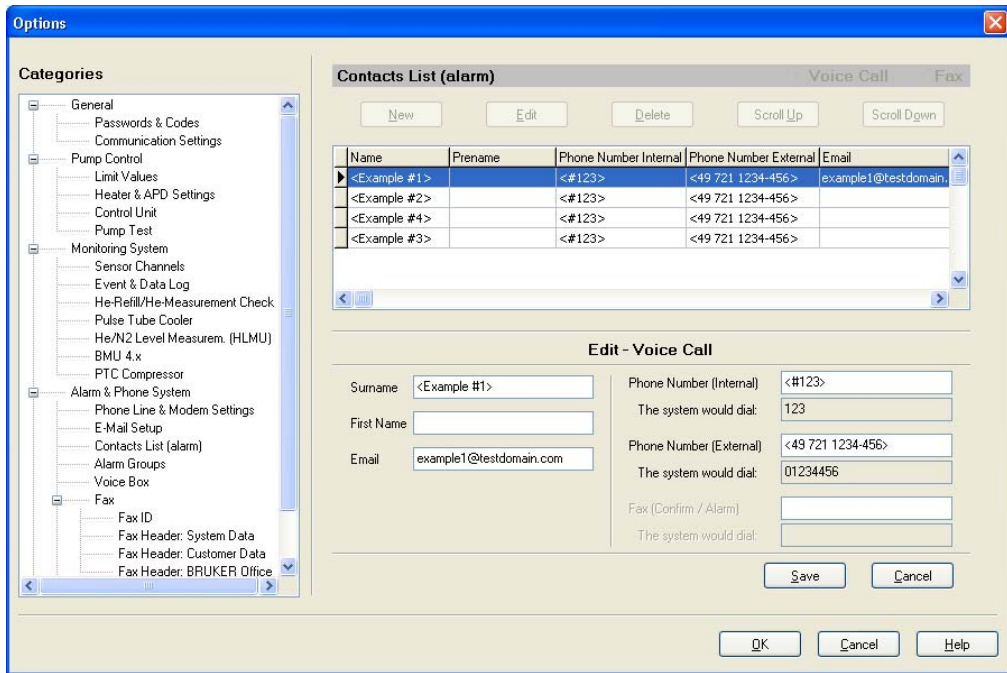

Figure 12.27: Tools - Options - Contact List (alarm) Edit Data

12.3.4.4 Alarm Groups

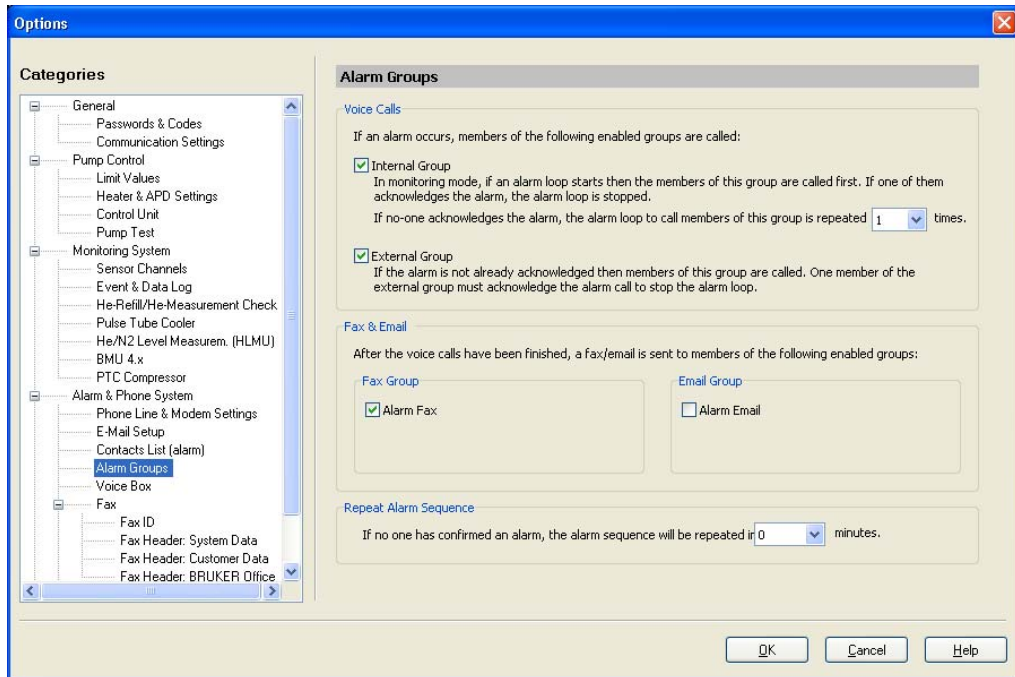

Figure 12.28: Tools - Options - Alarm Group Settings

In this window you can modify the group alarm settings.

- **Internal Group:** When this box is checked the members of the internal contact list are called when an alarm occurs. You can also specify how many times the call will be repeated if no one responds.
- **External Group:** When this box is checked the members of the external contact list are called if the internal group does not acknowledge the alarm. The call will be repeated until a member of the group responds.
- **Fax Group:** After the internal and/or external group is contacted a fax is sent to one or more of the fax groups if the boxes are checked. When an alarm fax is sent to an external receiver it is always meaningful to also send a confirmation fax to the same receiver so they are informed about the situation.
- **E-mail Group:** When this box is checked e-mails are sent to the members of the group after the fax group has been notified.
- **Repeat Alarm Sequence:** Here you can enter an interval for how long the system should wait before it repeats the alarm sequence when no one confirmed the alarm previously. Default is zero minutes.

12.3.4.5 Voice Box

The voice box editor is used to setup the voice box system. This system is pre-configured by Bruker service and does not need to be modified.

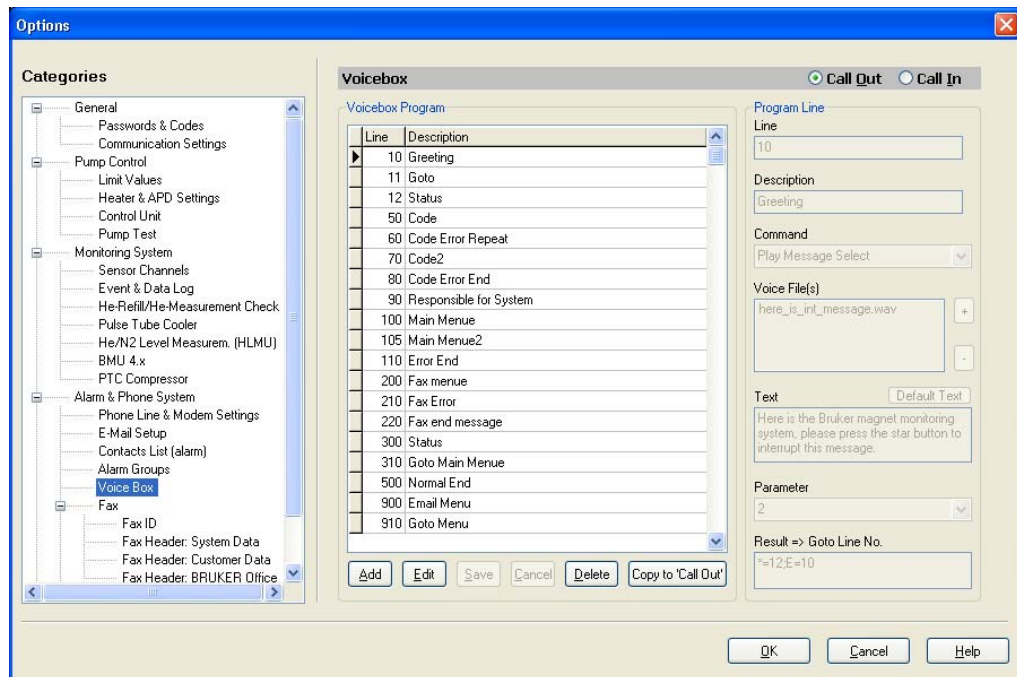

Figure 12.29: Voice Box Configuration Editor

12.3.4.6 Fax

In this window you can enter a default fax number. This fax number will be used, when selecting the default fax number while requesting a status fax. Please refer to section ["Remote Status Request" on page 70](#).

12.3.4.7 Fax - Fax ID

All adjustments in the Fax settings window are used to configure the fax text. The Fax ID fields appear in the header of the fax that is sent.

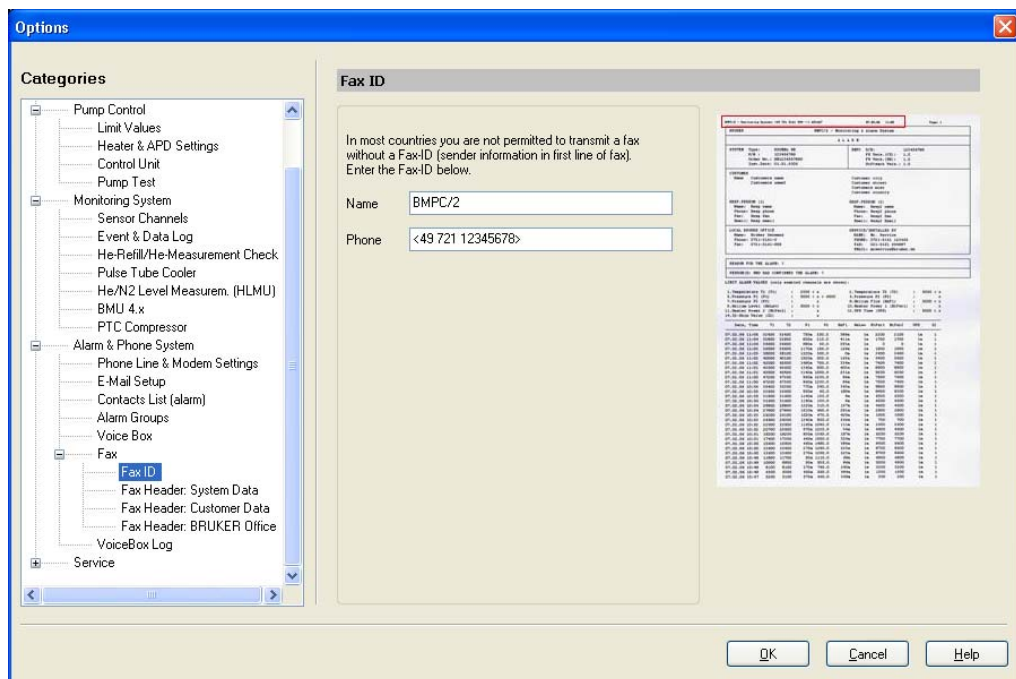

Figure 12.30: Tools - Options - Fax ID

- Name: Enter a meaningful name, such as your company and device name. This information will appear in the status line of the fax.
- Phone: Enter the number used to reach the BMPC/2.

12.3.4.8 Fax - Fax Header - System Data

This window is used to enter all the data concerning the magnet system and BMPC/2.

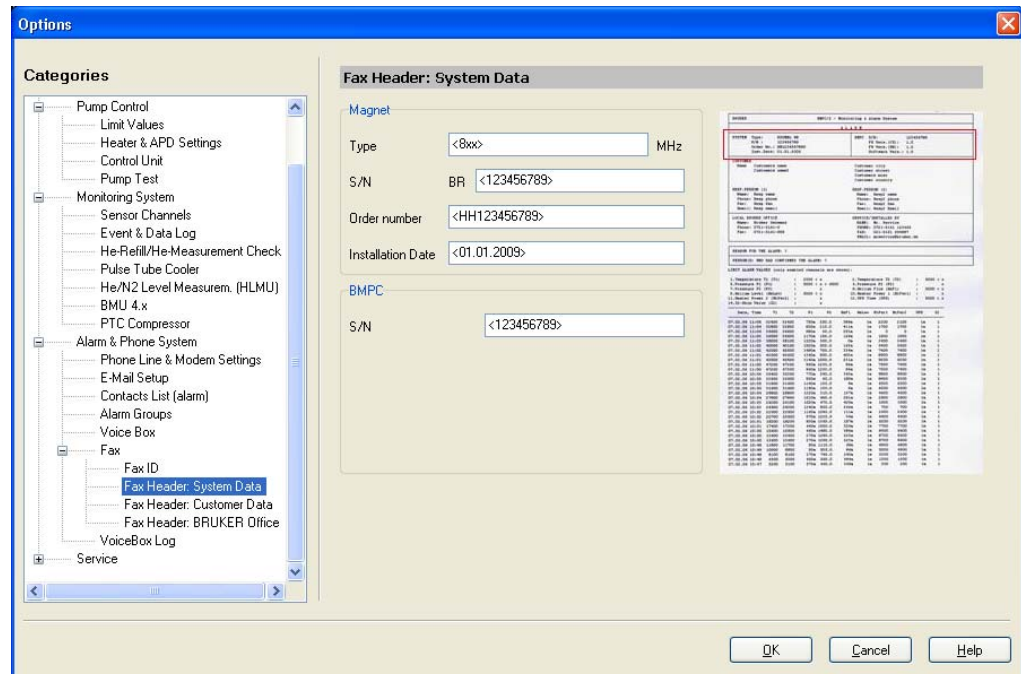

Figure 12.31: Tools - Options - Fax Header: System Data

- Magnet Type: The magnet frequency and design.
- Magnet S/N: The serial number of the magnet.
- Magnet Order Number: The Bruker order number.
- Magnet Installation Date: The date of the installation.
- BMPC P/N: The part number of the BMPC/2 H13035.

12.3.4.9 Fax - Fax Header - Customer Data

In this window the data for your company, including the name and contact information of the individuals responsible for the system must be entered. This information is used to contact your company, if necessary, when Bruker receives an alarm fax.

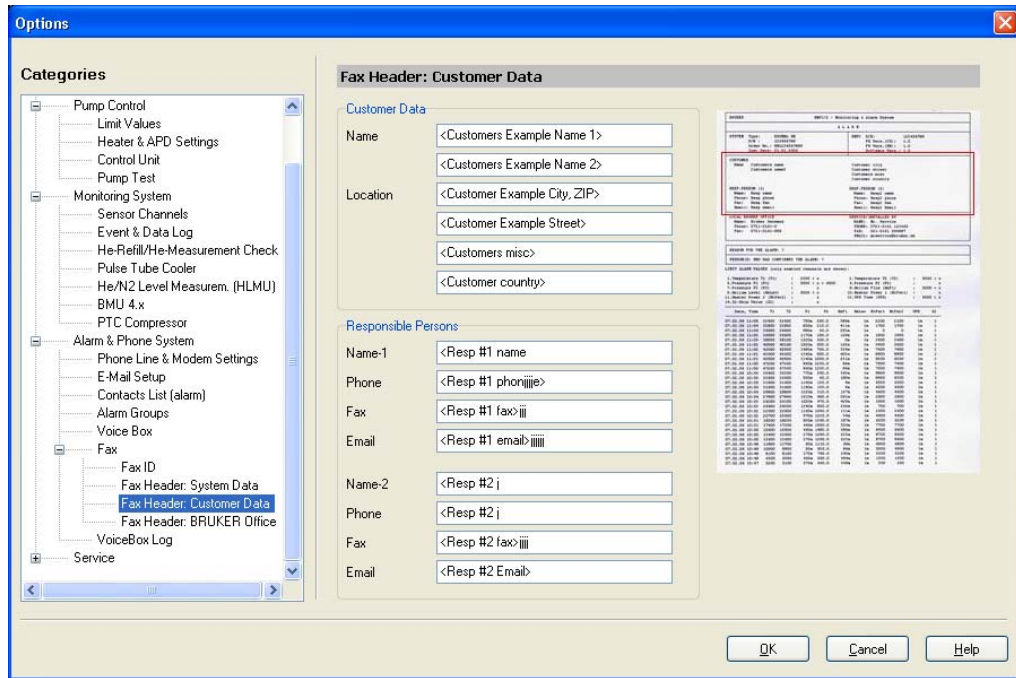

Figure 12.32: Tools - Options - Fax Header: Customer Data

12.3.4.10 Fax - Fax Header - Bruker Office

In this window the data for your local Bruker office and the name of the service engineer that installed the system are maintained.

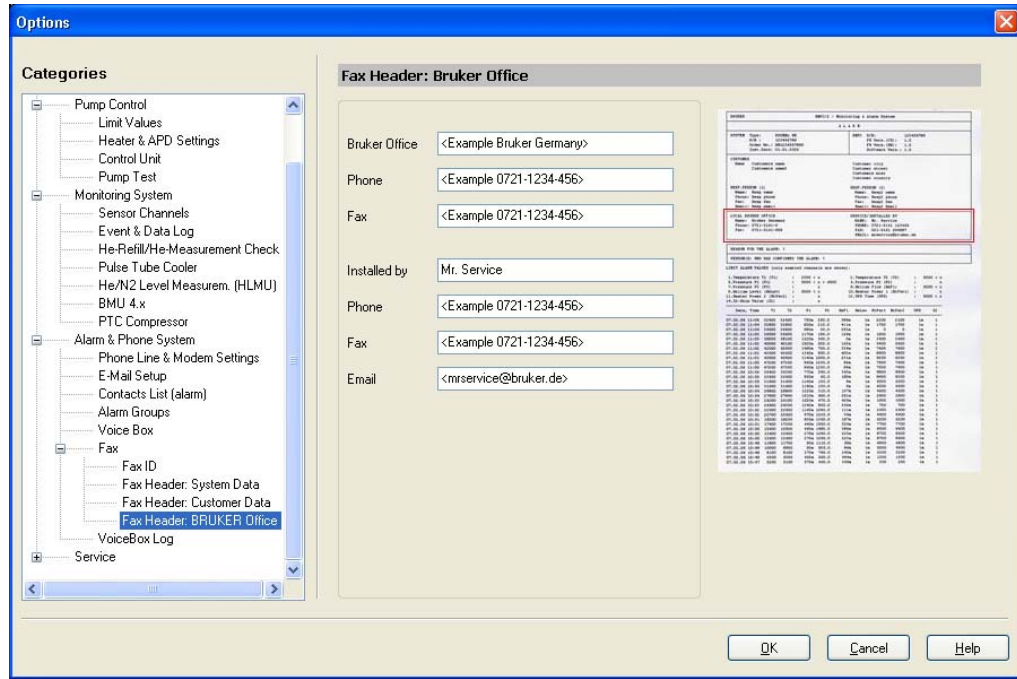

Figure 12.33: Tools - Options - Fax Header: Bruker Office

12.3.4.11 Fax - Voice Box Log

In this window you can adjust the settings for the Voice Box Log. Since this function serves primarily for error tracing in telephone systems you can use a relatively short log recording duration. It is the same rules as for the Data and Event logs (see "[Event & Data Log](#)" on page 95).

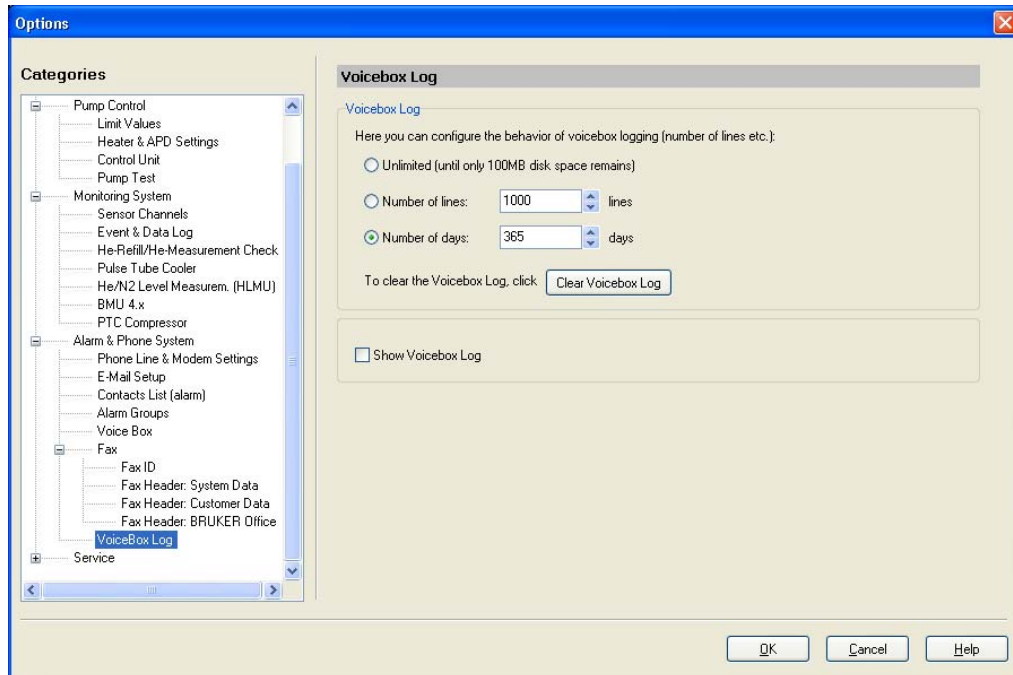

Figure 12.34: Tools - Options - Fax Voice Box Log

When you check the Show Voice Box Log check box, the Voice Box Log window will be displayed as long as you remain in this window.

12.3.5 Service

The service area is only accessible by Bruker service personnel.

13 Maintenance and Cleaning

13.1 Maintenance Work

To prolong the life of the BMPC/2, Bruker recommends that the maintenance work in this chapter be carried out on a regular basis.

13.1.1 Exchanging the Internal UPS Battery

The batteries for the internal UPS (Uninterruptable Power Supply) have a limited life-time. After 4 to 6 years the capacity normally is reduced significantly.

Bruker recommends that the batteries be exchanged every 5 years. Please call Bruker service for assistance.



WARNING

High voltage present inside the UPS

There is high voltage present inside the UPS, even when the UPS is switched off or disconnected!

- ▶ Exchanging the batteries must be done by trained personnel.

When the „Battery Fault“ indicator appears during operation, refer to the appropriate chapter in the UPS manual for troubleshooting instructions.

13.2 Cleaning

No special cleaning has to be carried out. Impurities can be cleaned using a standard household cleaner and cleaning tissues.

Do not use strong cleaning solvents, as they may damage the surface of the BMPC/2.

To clean the LCD panel use a special LCD detergent manufactured for this purpose.

14 Troubleshooting

14.1 Information Window Messages

When an error occurs an error message is displayed inside the information (Info) window and must be acknowledged by the user.

These error messages typically need intervention by the user. For example, the error message „Warning possible fan failure pump cabinet“ may be generated because of a faulty fan inside the pump cabinet. This should alert the user to check the function of the three fans inside the pump cabinet.

After the error has been corrected, the error message can be acknowledged by pressing the **Acknowledge** button. If the error still remains, it is possible that the same error message will be repeated a few minutes later.

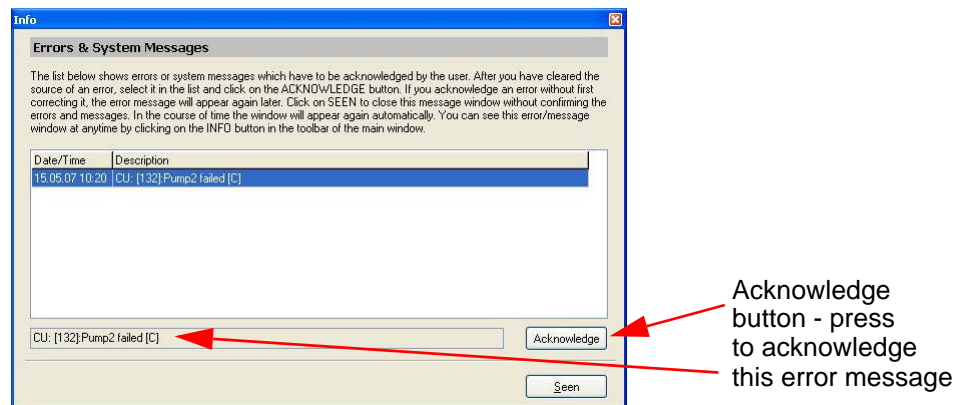

Figure 14.1: Information Window

The information can be closed temporarily by pressing the **Seen** button. The error messages will be periodically displayed in the information window as long as they have not been acknowledged. If all the error messages have been acknowledged, then the information window will remain closed.

14.1.1 Description of Error Messages

The following section contains a description of some of the common error messages that might be displayed, as well as a solution to the problem.

14.1.1.1 Limit Data P1 failed

It was not possible to read the limit data for the pressure P1 from the EEPROM, thus supervision of the Pressure P1 is not possible.

Solution: Using the function „Read from Backup Database“ from the menu *Tools - Options - Limit Values* (see "[Limit Values](#)" on page 90) you are able to read the limit values stored on the PC's hard disk.

To solve this problem you will need to reload the values from the backup database to the BMPC/2 Control Unit using the „Write Values“ function.

14.1.1.2 Limit Data T1 Failed

It was not possible to read the limit data for the temperature T1 from the EEPROM, thus supervision of the temperature T1 is not possible.

Solution: Reload the values from the backup database to the BMPC/2 as shown for Limit Data P1 fail.

14.1.1.3 Limit Data T2 Failed

It was not possible to read the limit data for the temperature T2 from the EEPROM, thus supervision of the temperature T2 is not possible.

Solution: Reload the values from the backup database to the BMPC/2 as shown for Limit Data P1 fail.

14.1.1.4 Limit Data T5 Failed

It was not possible to read the limit data for the temperature T5 from the EEPROM, thus supervision of the temperature T5 is not possible.

Solution: Reload the values from the backup database to the BMPC/2 as shown for Limit Data P1 fail.

14.1.1.5 Limit Data Flow Failed

It was not possible to read the limit data for the helium flow FI from the EEPROM, thus supervision of the helium flow FI is not possible.

Solution: Reload the values from the backup database to the BMPC/2 as shown for Limit Data P1 fail.

14.1.1.6 Limit Data Helium Level Failed

It was not possible to read the limit data for the helium level from the EEPROM, thus supervision of the helium level is not possible.

Solution: Reload the values from the backup database to the BMPC/2 as shown for Limit Data P1 fail.

14.1.1.7 Calibration T1 Failed

It was not possible to read the calibration values for the calculation of the magnet temperature T1 from the EEPROM, thus calculation and supervision of the temperature T1 is not possible.

Solution: A software reset of the BMPC/2 Control Unit usually helps (see also ["Control Unit" on page 93](#)). If not, you will need to recalibrate the temperature T1 (see also chapter ["Calibrate Temperature Linearization Function" on page 76](#)).

14.1.1.8 Calibration T2 Failed

It was not possible to read the calibration values for the calculation of the magnet temperature T2 from the EEPROM, thus calculation and supervision of the temperature T2 is not possible.

Solution: A software reset of the BMPC/2 Control Unit usually helps (see also ["Control Unit" on page 93](#)). If not, you will need to recalibrate the temperature T2 (see also chapter ["Calibrate Temperature Linearization Function" on page 76](#)).

14.1.1.9 Calibration T5 Failed

It was not possible to read the calibration values for the calculation of the pump cabinet temperature T5 from the EEPROM, thus calculation and supervision of the temperature T5 is not possible.

Solution: A software reset of the BMPC/2 Control Unit usually helps (see also ["Control Unit" on page 93](#)).

14.1.1.10 Heater Initialization Failed

The initialization values for the pressure regulation for pressure P2 using the magnet heater could not be read from the EEPROM, thus the pressure regulation could not be activated.

Solution: Reenter the data for the pressure regulation using the menu *Tools - Options - Heater & APD Setting*.

14.1.1.11 Resistor Initialization Failed

It was not possible to read the data for the heater resistors H1 and H2 from the EEPROM. For the calculation of the heater power, the default values are used (100 Ohm), therefore the calculation may be wrong.

Solution: Reenter the data for the heater resistor using the menu *Tools - Options - Heater & APD Setting*.

14.1.1.12 APD Initialization Failed

It was not possible to read the configuration data for the absolute pressure device (APD) from the EEPROM, thus the pressure regulation via the APD could not be started.

Solution: Reenter the data for the heater resistor using the menu *Tools - Options - Heater & APD Setting*.

14.1.1.13 Heater Regulation Initialization Failed

The parameters for the pressure regulation using the heater H1 could not be read from the EEPROM, thus the default data was loaded. This data may not be optimal for your type of magnet, and therefore the pressure regulation may be imprecise.

14.1.1.14 Warning, Power Supply GS1 failed

The power supply GS1 in the BMPC/2 Line Control Unit failed.

Solution: The redundant power supply GS2 has taken over the function of GS1. Please check the GS1 fuse as shown in section ["Exchanging the GS1 or GS2 Power Supply Fuses" on page 135](#). If this does not solve the problem the power supply GS1 must be replaced with a new one. Please contact your local Bruker Service department.

The Bruker part number for this power supply is: **87491**.

14.1.1.15 Warning, Power Supply GS2 failed

The power supply GS2 in the BMPC/2 Line Control Unit failed.

Solution: The redundant power supply GS1 has taken over the function of GS2. Please check the GS2 fuse as shown in section ["Exchanging the GS1 or GS2 Power Supply Fuses" on page 135](#). If this does not solve the problem the power supply GS2 must be replaced with a new one. Please contact your local Bruker Service department.

The Bruker part number for this power supply is: **87491**.

NOTICE

Power Supply Failure

Even though the BMPC/2 works with a faulty power supply, it is strongly recommended that you replace the fuse and/or the power supply as soon as possible. If the second redundant power supply also fails you can no longer control the BMPC/2.

- ▶ Replace the fuse and/or power supply as soon as possible.

14.1.1.16 Warning, Possible Fan Failure Pump Cabinet

A strong temperature rise inside the pump cabinet could be caused by a defective fan.

Solution: Check the fans inside the pump cabinet to see if they are functioning. It is possible that a fuse from one of the fans has blown. For instructions on how to exchange a fuse please read the section "[Exchanging the Pump Cabinet Ventilator Fuse](#)" on page 133.

Remark: This situation also can appear while opening or closing the front door of the pump cabinet.

14.1.1.17 Helium Measurement Error

If you are using a bath cooled system, and the helium level has not changed for a longer period of time, the value for the helium level is probably wrong. For more information read the section "[He-Refill / He Measurement](#)" on page 96.

Solution:

1. Check the function of the Helev transfer program. This program transfers the helium level information and some other data once a day from the BSMS to the BMPC/2. This program must be running in order for the BMPC/2 to receive the newest data.
2. Check for a good cable connection between the He-Lev Sensor and the BSMS.
3. The calibration of the He-Lev Sensor may also be wrong.

14.1.1.18 Pump 1 Failed

Pump 1 has failed or does not work correctly. If the pump was working in automatic mode the BMPC/2 is now using Pump 2.

Solution:

1. Switch to manual pump mode.
2. Switch on Pumpn1, but do not open valve V1, and check to see if the pump is working correctly.
3. If not, check the motor protection switch QM1. To do this open the upper rear panel of the BMPC/2, QM1 is located on the upper left side of the BMPC/2 line control unit.

4. Press the black QM1 button and check if the pump now works.
5. If the pump still does not work, check the on/off switch for the pump itself. The on/off switch is located near to the mains cable input of the pump.
6. If the pump still fails, it must be replaced.

For instruction on how to exchange a pump please read section "[Pump Replacement on Bath-Cooled Systems](#)" on page 126 or "[Pump Replacement on Systems with Helium Recovery](#)" on page 128, if you are using a system with helium recovery.

14.1.1.19 Valve 1 Failed

The valve V1 could not be switched or is not working correctly.

Solution:

1. Switch to the manual pump mode.
2. Switch on Pump 1, and check the function of the valve by switching it on and off.
3. If the valve does not work, check the fuse Q4. To do this open the upper rear panel of the BMPC/2, the Q4 fuse is located on the upper left side of the BMPC/2 line control unit. The black Q4 switch must be in the up position.
4. Recheck if the valve works, if it still does not work call bruker service for assistance.

14.1.1.20 Pump 2 Failed

Pump 2 has failed or does not work correctly. If the pump was working in automatic mode the BMPC/2 is now using Pump 1.

Solution:

1. Switch to the manual pump mode.
2. Switch on Pump 2, but do not open valve V2, and check to see if the pump is working correctly.
3. If not, check the motor protection switch QM2. To do this open the upper rear panel of the BMPC/2, and press the black QM2 button located on the upper left side of the BMPC/2 line control unit.
4. Check if the pump now works.
5. If the pump still does not work check the on/off switch of the pump itself. The on/off switch is located near the mains cable input of the pump.
6. If the pump is not working, it must be replaced.

For instruction on how to exchange a pump please read section "[Pump Replacement on Bath-Cooled Systems](#)" on page 126 or "[Pump Replacement on Systems with Helium Recovery](#)" on page 128, if you are using a system with helium recovery.

14.1.1.21 Valve 2 Failed

The valve V2 could not be switched or is not working correctly.

Solution:

1. Switch to the manual pump mode.
2. Switch on Pump 2, and check the function of the valve, switching it on and off.
3. If the valve does not work, check the fuse Q5. To do this open the upper rear panel of the BMPC/2, the Q5 fuse is located on the upper left side of the BMPC/2 line control unit. The black Q5 switch must be in the up position.
4. Recheck if the valve works, if it still does not work call Bruker service for assistance.

14.1.1.22 Warning Commercial Power Failed

The input power to the external UPS has failed due to a commercial power failure.

Solution: If the power failure was not due to a commercial power outage, check the mains supply chain, perhaps one of the facility fuses has blown.

14.1.1.23 Alarm UPS Low Battery

The backup battery is low and will only supply power for a few more minutes.

Solution: Reestablish power to the unit (e.g. emergency generator or similar if power is not available).

14.1.1.24 Warning UPS on Bypass

The UPS is working in automatic bypass mode. This means that the UPS cannot switch to battery backup mode in case of a power failure.

Solution: Check the output load of the UPS. If this is too high (load on the NMR console), the UPS switches to the automatic bypass mode.

14.1.1.25 Warning UPS General Alarm

The warning message for the UPS may vary according to the make and model of the unit. Read the UPS manual that was delivered with the UPS for information on the meaning of the general alarm message.

14.1.1.26 Warning UPS Not Connected

The status interface between the BMPC/2 and the UPS is not connected. Therefore the BMPC/2 will not receive any information about the UPS status. In the event of a longer power failure no alarm procedure will be activated when the UPS battery fails. Additionally it is not possible to enable the console output.

Solution: Check the connection between the UPS and the BMPC/2. The cable HZ13979 must be connected at X6, which is located on the lower right side of the BMPC/2 line control unit and to the external UPS status interface.

14.1.1.27 Warning Heater H1 Problem

This warning indicates that there is a possible problem with the heater H1. The real output power does not correspond to the desired output power.

Solution: Please check the connection between the wiring box and the heater H1 (cable HZ13813).

14.1.1.28 Warning Heater H2 Problem

This warning indicates that there is a possible problem with the heater H2. The real output power does not correspond to the desired output power.

Solution: Please check the connection between the wiring box and the heater H2 (cable P/N HZ13811).

14.1.1.29 Pump Test Not Possible in Manual Mode

The automatic pump test can not be started in manual pump mode.

Solution: Use the automatic pump mode.

14.1.1.30 Pump Test Not Started

The automatic pump test could not be started due to an internal error. Notify Bruker service.

14.1.1.31 Pump Test Not Possible, Both Pumps in Use

The automatic pump test could not be started because both pumps were in use when the pump test was started.

Solution: Wait until the next automatic pump test or start the pump test manually. To start the pump test manually select *Tools - Options - Pump control - Pump Test*.

14.1.1.32 Pump Test Pump 1 Failed

The automatic pump test detected that the Pump 1 does not work reliably.

Solution: Check the pump very carefully, if it is not working properly, exchange the pump with the spare pump. To change the pump read the section "[Pump Replacement on Bath-Cooled Systems](#)" on page 126 or "[Pump Replacement on Systems with Helium Recovery](#)" on page 128, if you are using a system with helium recovery.

14.1.1.33 Pump Test Pump 2 Failed

The automatic pump test detected that the Pump 2 does not work reliable.

Solution: Check the pump very careful. If it is not working correctly, exchange the pump with the spare pump. To change the pump read the section "[Pump Replacement on Bath-Cooled Systems](#)" on page 126 or "[Pump Replacement on Systems with Helium Recovery](#)" on page 128, if your are using a system with helium recovery.

14.1.1.34 Pump Test Not Possible, Parameter Error

The automatic pump test could not be started because the parameters for helium flow „FI“ and/or pressure1 „P1“ could not be read correctly.

Solution: Read the section "[When the Value of a Parameter is Displayed as NAN](#)" on page 125.

14.2 Messages in the Event Log

Any messages that appear during operation of the BMPC/2 are displayed In the Event Log of the „Present Values/Events“ window. In addition the messages are stored in the Event Log file.

There are several different kinds of messages, which can be displayed or hidden using the filter adjustment of the event log browser:

- **Warning:** The upper or lower limits of a warning limit have been surpassed.
- **Alarm:** The upper or lower limits of an alarm limit have been surpassed.
- **Misc:** A general message, e.g. change of mode.
- **Control Unit:** All messages are transferred from the BMPC/2 through the serial port. These error message are marked with the prefix „CU“.

14.2.1 Additional Error Messages in the Event Log

CAN Network Reboot

CAN Slave General

CAN Slave No Data

CAN Slave Initialization Failed

CAN Slave Unexpected Answer

CAN Slave Hardware Error

CAN Slave SBS Error

CAN Slave Reset Event

CAN Fatal RTX Initialization Failed

CAN Fatal RTX Internal

All of these error messages relate to a malfunction of the CAN bus. Carry out the step listed in the section "[When the Value of a Parameter is Displayed as NAN](#)" on page 125. When this does not correct the error, contact Bruker service.

14.3 Error Message at the Start of BMPC/2 Control Program

The following error messages may occur at the start of the BMPC/2 control program:

- Database Update Error
- Version Check Error
- COM Port Error

These errors are described in the following sections.

14.3.1 Database Update Error

When the BMPC/2 control program is started and the Database Update window appears it normally means the program has loaded an old version of the database structure due to a recent program update.

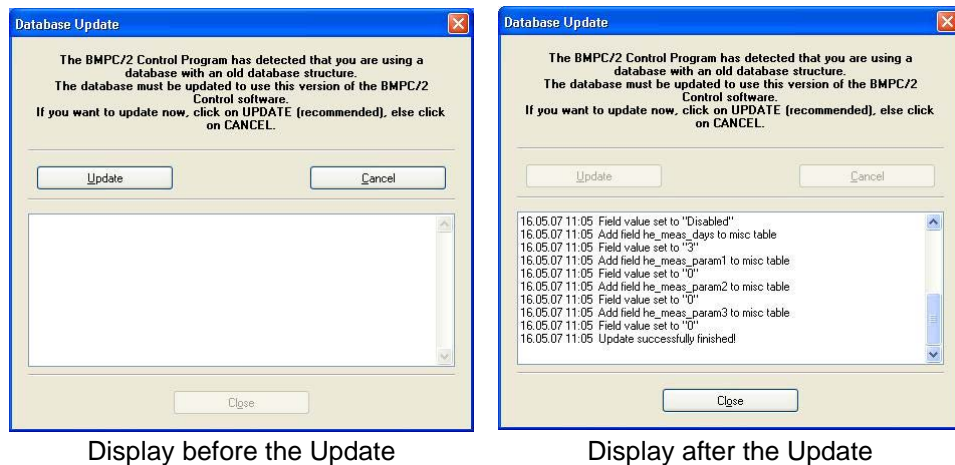

Figure 14.2: Update Database Error

To use the new program version you will need to update the database. Press the **Update** button to update the database, or **Cancel** to close the window. If you close the window without updating the database you **will not** be able to start the control program. Once you have updated the database you can then press **Close** and you will be able to start the control program.

14.3.2 Version Check Error

The BMPC/2 control program requires a firmware version of VX.Y or higher. When this is not the case, the communication between the PC and the BMPC/2 control unit will not function properly. Refer to the section "[Downloading New Firmware](#)" on page 74 for information on how to download the latest version of firmware.

14.3.2.1 COM Port Error

When a COM Port error occurs, it means that the communications port used for communication with the BMPC/2 cannot be used.

Either the port is in use from another program (e.g. SBS terminal or the BMPC/2 Setup Tool), or the cable connection to the control unit is not functioning correctly.

The standard configuration for the COM Port is COM1. Please check this configuration in *Tools - Options - General - Communication Setting*. Also refer to section "[Communication Settings](#)" on page 89.

14.4 Other Errors

14.4.1 When the Value of a Parameter is Displayed as NAN

When the value of a parameter is displayed as NAN (Not A Number), it means that the value of a sensor that is connected to the CAN bus cannot be read. This can lead to various consequences.

Solution:

1. Try to re-initialize the CAN bus by doing a software reset of the BMPC control unit (see "[Control Unit](#)" on page 93).
2. If this is not successful, try to turn the control unit on and off by opening and closing the Q10 safety fuse on the BMPC/2. This is accessible by opening the rear side, upper cover of the BMPC. The Q10 safety fuse is on the upper left-hand side.
3. Compressor: Check the power supply, cables, etc.

When this still not solves the problem, check the CAN bus wiring (see "[CAN Bus](#)" on page 26).

14.5 Pump Replacement on Bath-Cooled Systems



WARNING

Cryogenic Substances

To avoid injury, cryogenic substances must be handled and stored in a safe manner.

- ▶ Refer to the magnet manual for information on the safe handling and storage of cryogenic substances.

When the vacuum pump needs to be replaced, the following steps have to be carried out in sequential order:

1. Switch the BMPC/2 to Monitor Only Mode, so that an alarm is not activated during the service work.
2. Switch the BMPC/2 to Manual Pump Mode. Use the intact pumps and the associated valve to pump to the magnet.
3. Loosen the 4 locking screws on the pump cabinet a quarter turn to the left and remove the front cover. You should now see Pump 1 on the left side and Pump 2 on the right side.



WARNING

Pump surface can cause serious burns!

The surface of the pumps can be extremely hot! Contact with this surface can result in a serious burn.

- ▶ Be sure that the valve from the pump you want to exchange is closed!

4. Loosen the two small flange screw connections that attach the evacuating hoses to the pump.

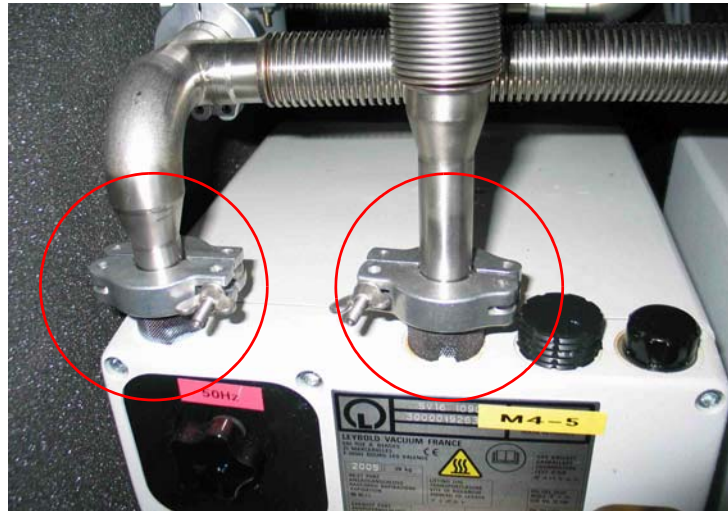

Figure 14.3: Remove the Small Flange Screws

5. Remove the flange screw connections and the associated seals.
6. Remove the mains connection from the backside of the pump.
7. Unscrew the screws holding the pump unit using an 8 mm open-end wrench.
8. Move the locking mechanism so that the pump tray with the defective pump can be moved freely.

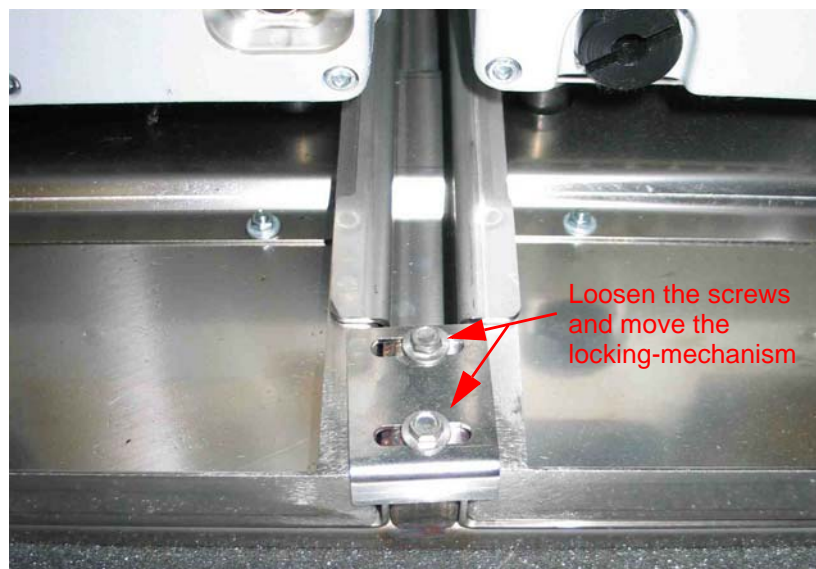

Figure 14.4: Pump Tray Locking Mechanism

9. Pull the pump forward on the pump tray. The tray can not be pulled out all the way, this is a safety measure which prevents it from falling out.
10. Exchange the defective pump with a new one.

i Check to make sure the new pump is ready for use before mounting it. This includes checking and refilling the oil level as required in the vacuum pump manual.

11. Push the pump tray back to its original position and reconnect the locking mechanism.
12. Mount both of the small flange screws including the seals on the new pump. Proceed carefully, the connections need to be completely sealed!
13. Plug in the mains cable on the pump and turn on the pump switch (beside the mains connection).
14. Test the new pump by turning the pump on manually (Pump 1 or Pump 2 on).
15. Test the new pump by comparing the pressure Pump 1 and helium flow FL values established by the new pump with the values of the old pump. These values should be nearly identical. It is possible you will need to wait one hour until the temperature of the pump has settled before the values stabilize.
16. Mount and close the front cover.
17. Place the BMPC/2 in Automatic Pump mode and in Monitor & Alarm mode.

14.6 Pump Replacement on Systems with Helium Recovery



WARNING

Cryogenic Substances

To avoid injury, cryogenic substances must be handled and stored in a safe manner.

- ▶ Refer to the magnet manual for information on the safe handling and storage of cryogenic substances.

In case of malfunction of the continuously operating pump (usually Pump 1), the back-up pump (usually Pump 2) has taken over and maintains continuous operation. In this operation state no further automatic back-up is available. In order to restore the automatic back-up functionality it is necessary to replace the defective pump as soon as possible.

NOTICE

Only use pump oil specifically approved for use with Bruker Aeon magnets.

The pumps for the Bruker Aeon magnet need specifically approved oil.

- ▶ Contact your Bruker service representative to obtain advice on suitable products. Fill it with oil to the specified level before use.

At systems with helium return it is necessary to avoid any contamination of the helium return loop with air. Therefore the pump replacement has to be performed as described in this chapter. During the replacement, check the expansion pressure reading P1 and the magnet temperatures T1 and T2 regularly. Before starting the replacement please get familiar with the complete replacement procedure, then proceed as follows:

1. Switch the BMPC/2 to Monitor Only mode to avoid an alarm during the service work. To do so a security code may be needed. This code is defined by Bruker but may have been changed by the customer.
2. Switch the BMPC II to the manual mode. The back-up pump should continue to work, but now controlled manually.
3. Close the return valve V3.

i It is assumed that the back-up pump is already running. If not, switch on the back-up pump and open the associated valve.

4. Loosen the 4 locking screws on the pump cabinet a quarter turn to the left and remove the front cover. You should now see the two pumps, Pump 1 on the left side and Pump 2 on the right side.

WARNING



Pump surface can cause serious burns!

The surface of the pumps can be extremely hot! Contact with this surface can result in a serious burn.

- ▶ Allow the defective pump to cool down.
- ▶ Avoid touching the operational pump. (Use the pump tray to pull out the defective pump.)

5. If the pump to be replaced (defective pump) is still running, close the associated valve and switch off the pump. Wait some minutes for the flow rate FL and the pressure Pump 1 to stabilize and write down both values.
6. Loosen the two KF clamps that attach the evacuating hoses to the pump.
<Figure 11.x Remove the Flange Clamps>
7. Remove the flange clamps and the associated seals.
8. Remove the mains connection from the backside of the pump.
9. Unscrew the screws holding the pump unit using an 8 mm open-end wrench.
10. Move the locking mechanism so that the pump tray with the defective pump can be moved freely.
<Figure 11.x Pump Tray Locking Mechanism>
11. Pull the pump forward on the pump tray. The tray cannot be pulled out all the way, this is a safety measure which prevents it from falling out.

NOTICE

Check the oil level of the spare pump.

The spare pump needs the required quantity of oil.

- ▶ If necessary please fill it with Aeon approved oil to the specified level before use.

12. Replace the defective pump with the spare pump.
13. Push the pump tray back to its original position and reconnect the locking mechanism.
14. Use new o-ring seals to mount both of the KF flanges on the new pump. Proceed carefully, the connections need to be completely tight!
15. Plug in the mains cable on the pump and turn on the pump switch (beside the mains connection).
16. Use the respective BMPC switch to switch on the replaced pump but leave the associated valve (V1 or V2) closed. Watch the flow meter. After several minutes and warm-up of the pump, the flow meter reading should reach the same value as noted down in (5). If the value is higher there is a leak in the connection from the pump to the valve or the pump itself. If the flow meter reaches the same value as in (5) and is stable, then open the associated valve (V1 or V2).
17. The back-up pump should still run. Keep pump at this speed, until the pressure Pump 1 in the pump line reaches a value below the value of the standard operating condition.
18. Close the valve of the back-up pump. Switch off the back-up pump. Watch the operating conditions for some time and check if FL and Pump 1 reach their standard values again.
19. Wait for one hour after the replaced pump has reached its operating temperature. Then, open V3.
20. When the heater power has stabilized below its limit in automatic mode and standard operating conditions are reached switch back the BMPC/2 to automatic mode.
21. Reactivate the Monitor & Alarm mode.

14.7 The NMR Console Switches Off Too Fast

i This chapter is applicable only if the BMPC II is operated with an NMR spectrometer.

The voltage supply for the NMR console supplies power to the BMPC/2. The NMR console is attached to terminal X3 of the BMPC/2 line control unit (see "Line Control Unit" on page 30). Since the NMR console may be supplied only for a short time by the batteries of the UPS during a power failure, it is automatically switched off by a time delay relay after a preset time.

The preset time can be adjusted anywhere between 1.5 minutes and 30 minutes. The following section explains how to adjust the time delay.

14.7.1 Adjusting the NMR Console Turn-off Time

The adjustment of the turn-off time is made through the KM3 relay. To access the relay open the upper back cover, the KM3 relay is found almost exactly in the middle of the line control unit.

To change the time you need to move the yellow turning wheel. Turn the wheel downwards to shorten the time (minimum of 1.5 minutes), upwards to lengthen the time (maximum of 30 minutes).

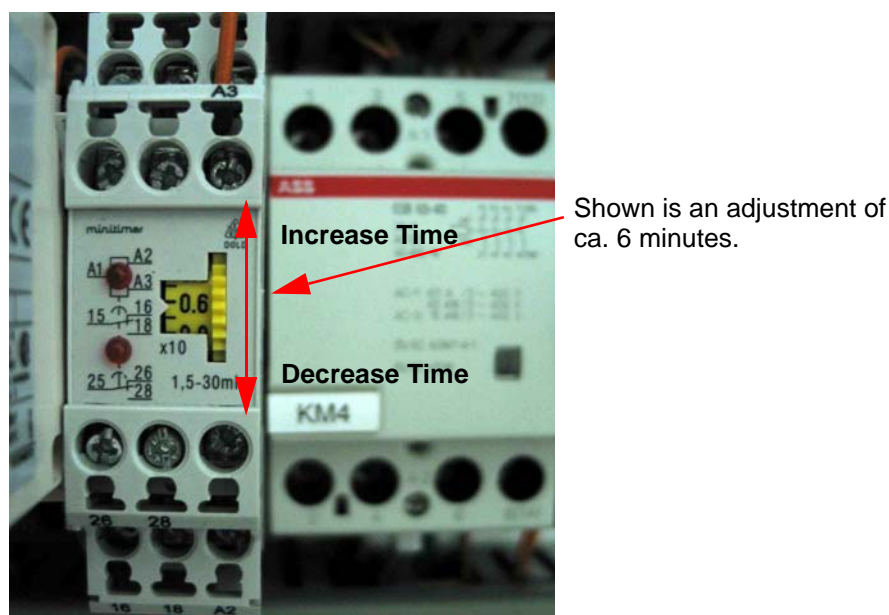

Figure 14.5: Adjusting the NMR Console Turn-off Time

i In the event of a **power failure**, the longer the console remains on the UPS, the shorter the time that the vacuum pumps will be powered. A favorable value is within the range of a maximum of 5 minutes.

14.8 Turning on the NMR Console After a Power Failure

When the NMR console switches off due to a power failure there are two different ways to restart it: when the power is restored:

- Restart the console through the software.
- Restart the console using the mains switch.

The console can only be switched on if the following conditions are fulfilled:

- The UPS must not be running under battery power.
- The status interface to the UPS must be attached.

14.8.1 Restarting the NMR Console Through the Software

In the menu *Tools* you will find the options *Enable NMR Console* and *Disable NMR Console*. When you are logged in as Administrator you can use these functions to turn the NMR console on or off.

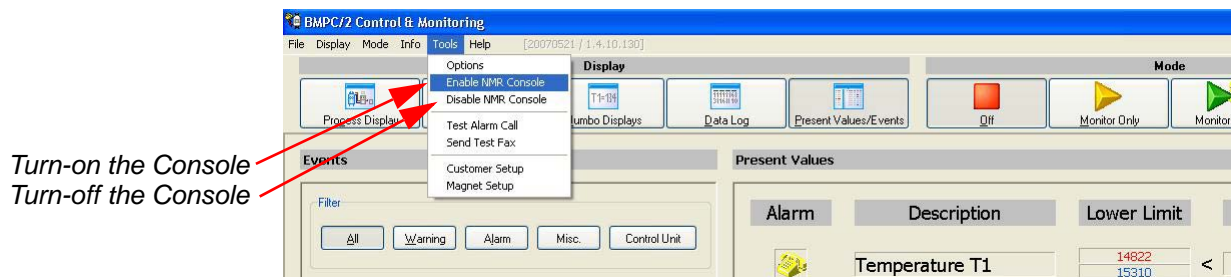

Figure 14.6: Restarting the NMR Console Through Software

14.8.2 Restarting the NMR Console Using the Mains Switch

If you cannot switch on the console using the software, you can alternatively use the S4 switch. The S4 switch is found behind the rear cover, roughly in the middle. As soon as you turn on this switch the KM4 contactor will be activated and the console will be provided with power.



The S4 switch is used to turn on the NMR console.

Figure 14.7: Restarting the NMR Console Using the S4 Switch

14.9 Exchanging Fuses

Several fuses are used within the BMPC/2. The following sections contain detailed instructions on how to change these fuses.

14.9.1 Exchanging the Pump Cabinet Ventilator Fuse

In the pump cabinet are a total of 3 ventilator fans. Each of these fans is protected by its own fuse.

The following fuse type is required for the pump cabinet fans:

- Cartridge fuse 5 x 20 mm 0.1 A time lag. The Bruker part number is **2241**.

To replace a fuse open the upper back cover of the BMPC/2. The fuse for the fans are located on the upper right side, marked as FU5, FU6 and FU7.

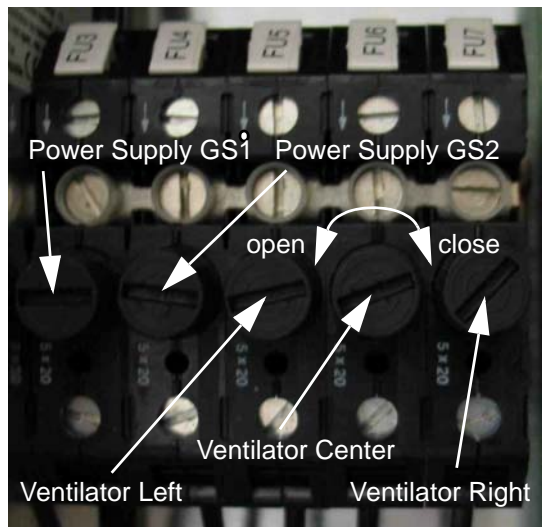

Figure 14.8: Exchanging the Ventilator Fuses

The FU5 fuse is found on the left side, the FU6 fuse in the center, and the FU7 fuse on the right side as shown in the figure above. To exchange a fuse you will need to unscrew the fuse caps with a flat-head screwdriver. Remove the fuse and insert a new one, then use the screwdriver to replace the fuse cap.

14.9.2 Exchanging the GS1 or GS2 Power Supply Fuses

There are two power supplies in the BMPC line control unit. Each of these power supplies has its own safety fuse.

The following fuse type is required for the power supplies:

- Cartridge fuse 5 x 20 mm 0.8 A time lag. The Bruker part number is **2250**.

The fuse for power supply GS1 is FU3 and the fuse for power supply GS2 is FU4. See the previous section ([14.9](#)) for instructions on how to exchange the fuse.

14.9.3 Exchanging the Control Unit Fuse

The BMPC/2 control unit utilizes two safety fuses.

The following fuse type is required for the control unit:

Cartridge fuse 5 x 20 mm 0.8 A time lag. The Bruker part number is **2250**.

To exchange a fuse in the control unit:

1. Remove the upper rear cover. To access the back of the control unit, unscrew the left and right side screws securing the line control unit using a cross-tip screwdriver and tilt the unit outwards.



Figure 14.9: Tilt Open the Line Control Unit

2. Remove the power supply plug from the control unit and open the fuse holder as shown in the figure below.
3. Remove the fuse insert and exchange both safety fuses.
4. Reassemble the unit in reverse order.



Figure 14.10: Replacing the Control Unit Fuse

15 Dismantling and Disposal

After the lifespan of the instrument, Bruker takes responsibility for disassembly and disposal in accordance with the European directive 2012/19/EC WEEE. Bruker BioSpin GmbH offers to take back the components free of charge after usage at the customer site upon request by the customer. If the customer wants to arrange disposal on their own, then this has also to be stated when the product is ordered.

16 Contact

Manufacturer:

Bruker BioSpin NMR
am Silberstreifen
D-76287 Rheinstetten
Germany
Phone: +49 721-5161-0
E-mail: nmr-support@bruker.de
<http://www.bruker.com>
WEEE DE43181702

NMR Hotlines

Contact our NMR service centers.

Bruker BioSpin NMR provide dedicated hotlines and service centers, so that our specialists can respond as quickly as possible to all your service requests, applications questions, software or technical needs.

If contacting Bruker always provide the serial number of your BMPC/2.

Please select the NMR service center or hotline you wish to contact from our list available at:

<http://www.bruker.com/service/information-communication/helpdesk/magnetic-resonance.html>

Appendix A

A.1 Warning Signs

Warning

High voltage present inside the UPS	113
Pump surface can cause serious burns!	126, 129

Caution

Never use pump 1 when valve 2 is open, or pump 2 when valve 1 is open	41
Heater and APD Settings	92

Notice

Changing the limit values	90
In manual mode the BMPC II will not react to critical magnet parameters	41
Phone System Test not working.	103
Power Supply Failure	119
Using the pump in manual mode	41

A.2 Figures

Figure 5.1:	System Block Diagram for Non-refrigerated Bath Cooled Aeon NMR Systems	17
Figure 5.2:	System Block Diagram Magnet Systems with Helium Recovery	18
Figure 5.3:	General Structure of the BMPC/2 Magnet Pump Control for Non-refrigerated Systems	19
Figure 5.4:	Interior of the Pump Cabinet	22
Figure 5.5:	BMPC/2 Line Control Unit.....	23
Figure 5.6:	BMPC/2 Wiring Box	25
Figure 5.7:	CAN Bus Structure.....	26
Figure 5.8:	External Wiring Overview for use with NMR Spectrometers.....	27
Figure 5.9:	Internal Wiring Overview	27
Figure 5.10:	BMPC/2 Control Unit Rear Panel.....	28
Figure 5.11:	Industrial PC Rear Panel	28
Figure 5.12:	UPS - Uninterruptible Power Supply (P/N 1802515)	29
Figure 5.13:	The UPS Circuit Breaker.....	30
Figure 5.14:	Line Control Unit Connector X3 / X4 / X5	31
Figure 5.15:	Line Control Unit Connector X6	33
Figure 7.1:	BMPC/2 Control Unit Front Plate	39
Figure 7.2:	Automatic Pump Mode vs. Manual Pump Mode.....	42
Figure 8.1:	BMPC/2 Login Screen	46
Figure 8.2:	Display Organization.....	47
Figure 8.3:	Display Buttons	48
Figure 8.4:	Process Display without Compressor	48
Figure 8.5:	Process Display with Compressor	49
Figure 8.6:	Graphical Display.....	50
Figure 8.7:	Graphical Display - Configuration X-axis	51
Figure 8.8:	Graphical Display - Configuration Y-axis	52
Figure 8.9:	Graphical Display - Zoom Function.....	53
Figure 8.10:	Jumbo Display	54
Figure 8.11:	Jumbo Display Configuration	54
Figure 8.12:	Data Log Display.....	55
Figure 8.13:	Present Values/Events Display	56
Figure 8.14:	Mode Buttons	57
Figure 8.15:	Present Values Display in Monitor & Alarm Mode	58
Figure 8.16:	Temperature T1 in the Present Value Display	58
Figure 8.17:	He Fill Mode 292 Minutes	59
Figure 8.18:	Alarm Temporarily Disabled.....	59
Figure 8.19:	Tools - Options - Control Unit - Pump Test - Configuration	61
Figure 8.20:	Event Log - Pump Test	62
Figure 8.21:	Tools - Options - Control Unit - Pump Test.....	63
Figure 9.1:	Present Values/Events in Alarm Mode	65
Figure 11.1:	Setup Tool Start Window	73
Figure 11.2:	Setup Tool - Download	74
Figure 11.3:	Setup Tool - Can Bus Diagnostic.....	75
Figure 11.4:	Setup Tool - Calibrate Temperature	76
Figure 12.1:	Magnet Setup Step 1	77
Figure 12.2:	Magnet Setup Step 2	78
Figure 12.3:	Customer Setup - Phone Line & Modem Settings	79
Figure 12.4:	Customer Setup - Contacts List (alarm).....	80
Figure 12.5:	Customer Setup - Alarm Groups.....	81

Figure 12.6: Customer Setup - Fax Setup - Fax ID	82
Figure 12.7: Customer Setup - Fax Setup - Fax Header.....	83
Figure 12.8: Customer Setup - Fax Setup - Fax Header (Customer).....	84
Figure 12.9: Customer Setup - Fax Setup - Fax Header (Bruker).....	85
Figure 12.10: Customer Setup - Summary.....	86
Figure 12.11: Tools - Options Menu.....	87
Figure 12.12: Tools - Options - Passwords & Codes	88
Figure 12.13: Tools - Options - Communication Settings.....	89
Figure 12.14: Tools - Options - Limit Values	90
Figure 12.15: Tools - Options - Heater & APD Setting.....	91
Figure 12.16: Tools - Options - Control Unit.....	93
Figure 12.17: Tools - Options - Sensor Channels	94
Figure 12.18: Tools - Options - Event & Data Log	95
Figure 12.19: Tools - Options - He-Refill / He Measurement	96
Figure 12.20: Tools - Options - Pulse Tube Cooler	97
Figure 12.21: Local Area Network Connections.....	98
Figure 12.22: Internet Protocol TCP/IP Properties	99
Figure 12.23: Helium/Nitrogen Measurement with the HLMU	100
Figure 12.24: Tools - Options - Phone Line & Modem Settings	102
Figure 12.25: Tools - Options - E-Mail Setup	104
Figure 12.26: Tools - Options - Contact List (alarm)	105
Figure 12.27: Tools - Options - Contact List (alarm) Edit Data	106
Figure 12.28: Tools - Options - Alarm Group Settings	106
Figure 12.29: Voice Box Configuration Editor	107
Figure 12.30: Tools - Options - Fax ID	108
Figure 12.31: Tools - Options - Fax Header: System Data	109
Figure 12.32: Tools - Options - Fax Header: Customer Data.....	110
Figure 12.33: Tools - Options - Fax Header: Bruker Office.....	111
Figure 12.34: Tools - Options - Fax Voice Box Log	112
Figure 14.1: Information Window	115
Figure 14.2: Update Database Error	124
Figure 14.3: Remove the Small Flange Screws	127
Figure 14.4: Pump Tray Locking Mechanism.....	127
Figure 14.5: Adjusting the NMR Console Turn-off Time	131
Figure 14.6: Restarting the NMR Console Through Software.....	132
Figure 14.7: Restarting the NMR Console Using the S4 Switch	133
Figure 14.8: Exchanging the Ventilator Fuses	134
Figure 14.9: Tilt Open the Line Control Unit.....	135
Figure 14.10: Replacing the Control Unit Fuse	136

A.3 Tables

Table 4.1:	General Information	15
Table 4.2:	Electrical Connection Values.....	15
Table 5.1	BMPC/2 Control Unit Components	20
Table 5.2	Fuse Overview	24
Table 5.3	Pin Count Connector X4	31
Table 5.4	Pin Count Connector X4	31
Table 5.5	Pin Count Connector X5	32
Table 5.6	Pin Count Connector X4	32
Table 5.7	Pin Count Connector X5	32
Table 5.8	Pin Count Connector X6	33
Table 7.1	P1 Pressure Monitoring	43
Table 7.2	T1/T2 Temperature Monitoring.....	44
Table 7.3	FL Helium Flow Monitoring	44
Table 10.1	Responding to an Alarm Call	69

A.4 Glossary

PTC

Pulse Tube Cooler

A.5 Index

A

Administrator Level	45
Alarm Groups	106
APD Settings	91
Automatic pump test	60

B

Battery	113
---------------	-----

C

CAN Bus	26
CAN Bus Diagnostic	75
Communication Settings	89
Contact List	105

D

Data Log Display	55
Display Mode	48, 51
DTMF	69

E

E-mail Setup	103
Event & Data Log	95
External Group	67

F

Fax	108
Fax Group	67
Fax Header - Bruker Office	111
Fax Header - Customer Data	110
Fax Header - System Data	109
Fax ID	108
Firmware - download	74
Fuses	133

G

Graphical Display	49
-------------------------	----

H

He Fill Mode	59
Heater Settings	91
He-Refill / He Measurement	96

I

Industrial PC	20
Internal Group	67

J

Jumbo Display	53
---------------------	----

L

Limit Values	90
Line Control Unit	23

M

Manual Mode	40
Monitor & Alarm Mode	58
Monitor Only Mode	57
Monitoring	43
Monitoring Helium Flow FI	44
Monitoring Pressure P1	43
Monitoring Temperature T1/T2	44

N

NAN	125
NMR Console	131, 132

O

OFF Mode	57
----------------	----

P

Password	87
Phone Line & Modem Settings	102
Present Values / Event Display	56
Process Display	48, 51
PTC	97
Pulse Tube Cooler	97

S

Sensor Channels	94
Service Level	45
Setup Tool	73
Status Request	70

T

Temperature calibration	76
TFT Display	19

U

UPS	21
User Level	45

V

voice box	69
Voice Box Log	112

Voice files 103

W

Wiring Box 25

Z

Zoom Function 52

 **Bruker Corporation**

info@bruker.com
www.bruker.com

Order No: Z31823