



# **BMSO H10052**

**User Manual**

**Version 001**



The information in this manual may be altered without notice.

BRUKER BIOSPIN BIOSPIN accepts no responsibility for actions taken as a result of use of this manual. BRUKER BIOSPIN BIOSPIN accepts no liability for any mistakes contained in the manual, leading to coincidental damage, whether during installation or operation of the instrument. Unauthorized reproduction of manual contents, without written permission from the publishers, or translation into another language, either in full or in part, is forbidden.

This manual was written by

Uwe Vogel

© August 20, 2004: Bruker Biospin GmbH

Rheinstetten, Germany

P/N: Z31705  
DWG-Nr: 1412001

# Contents

	<b>Contents .....</b>	<b>iii</b>
<b>1</b>	<b>About This Manual.....</b>	<b>5</b>
1.1	Introduction .....	5
1.2	Disclaimer .....	5
1.3	Warning and Notes .....	5
1.4	Contact Information for Additional Technical Assistance .....	6
1.5	Declaration of Conformity .....	7
<b>2</b>	<b>Terms and Definitions .....</b>	<b>9</b>
<b>3</b>	<b>BMSO General Information.....</b>	<b>11</b>
3.1	Purpose .....	11
3.2	Acceptable Usage .....	11
3.3	Heating Chamber Physical Specifications BMSO .....	12
3.4	Security Recommendations .....	13
<b>4</b>	<b>Preparation Before First Usage.....</b>	<b>15</b>
4.1	Overview of Location .....	15
4.2	Safety Installation .....	18
4.3	BMSO Assembly After Unpacking .....	20
	Install UV Cells .....	20
	Install Columns .....	25
	Nomenclature of the Capillary Numbering .....	26
	Nomenclature of the Valve Numbering .....	26
	Installing the BMSO Waste Capillaries .....	27
4.4	Initial Connections to the Standalone Unit .....	28
	Installing the External Parts .....	28
4.5	Initial Connections to the MicroBay Cabinet .....	29
<b>5</b>	<b>Operating Instructions .....</b>	<b>33</b>
5.1	Functional Description .....	33
5.2	Optional Cooling Port .....	35
	Cooling Recommendations .....	35
5.3	Safety Information .....	37
5.4	Front Panel Connections .....	38
5.5	Rear Panel Connections .....	38
5.6	The Heating Chamber .....	39
5.7	The Rear Chamber .....	40
5.8	Valve Numbering .....	41

<b>6</b>	<b><i>Service Information</i></b> .....	<b>45</b>
6.1	General Information .....	45
	Maintenance .....	46
	Maintenance Required for Long-term Storage .....	47
6.2	Replacing Fiber Optics Cables .....	47
6.3	Drawer Handling During Servicing .....	48
6.4	Using the Correct Ferrules and Fittings .....	49
	Rheodyne Valve Fittings .....	49
	Vici Valves Fittings .....	50
	Front Plate Connector Fittings .....	52
	UV Cell Fittings .....	53
6.5	Replacing the Air Actuator Valve .....	53
6.6	Replacing the Electric Actuator (Column Selection) Valve ..	55
6.7	Part List .....	56
6.8	Capillary Wiring .....	57
	BMSO Capillary Internal Wiring .....	57
	Capillary Wiring in Standalone Unit .....	60
<b>7</b>	<b><i>Serial Interface Control</i></b> .....	<b>61</b>
7.1	BMSO RS232 Connector .....	61
7.2	BMSO Control over an Ethernet Interface .....	62
<b>8</b>	<b><i>Cable Wiring</i></b> .....	<b>63</b>
8.1	Boards in the BMSO .....	63
	Fan Connector X5 .....	64
	BIS Connector X14 .....	65
	Control Board Connectors .....	66
	Power Connector X9 and Remote Connector X20 .....	67
<b>9</b>	<b><i>Error Guide</i></b> .....	<b>69</b>
9.1	Leakage Detected .....	69
9.2	Defective Capillary .....	69
9.3	No Heating is Possible .....	69
9.4	Not Possible to Open the Drawer .....	69
9.5	Warnings and Error Messages .....	70
<b>10</b>	<b><i>Embedded Web Server</i></b> .....	<b>71</b>
10.1	The BMSO Homepage .....	71
	Homepage Status Display .....	73
10.2	The BMSO Service Pages .....	77
	The Main Page: 'ews.html' .....	77
	The Device Information Page: 'info.html' .....	78
	The Service Page: 'service.html' .....	79
	The Operation Mode Settings Page: 'oper.html' .....	80
	The Valve Position and Variable Setting Page: 'valves.html'	
	.....	81
	The Heater Settings Page: 'heating.html' .....	82
	The Miscellaneous Settings (Misc) Page: 'misc.html' .....	83
	The BMSO Messages Page: 'messages.html' .....	84

	The Setup Page: 'setup.html' .....	85
<b>11</b>	<b><i>FTP Download</i></b> .....	<b>87</b>
11.1	Ethernet Program Download .....	87
11.2	Ping a Unit to check the connection .....	90
<b>A</b>	<b><i>Appendix</i></b> .....	<b>93</b>
A.1	Valve Usage Information .....	93
	The 6-Way Column Selector .....	93
	The 6-Port 3L 2 Position Valve with Air Actuator .....	93
	The Injection Valve .....	94
	<b><i>Figures</i></b> .....	<b>95</b>
	<b><i>Tables</i></b> .....	<b>99</b>



# About This Manual

# 1

---

## **Introduction**

**1.1**

This manual is included with the delivery of the BMSO (EC00) unit. It provides instructions on how to:

- Install and configure the BMSO unit.
- Wire and operate the unit.
- Service and maintain the unit.

---

## **Disclaimer**

**1.2**

The unit should only be used for its intended purpose as described in this manual. Use of the unit for any purpose other than that for which it is intended is taken only at the users own risk and invalidates any and all manufacturer warranties.

Service or maintenance work on the unit must only be carried out by qualified personnel.

---

## **Warning and Notes**

**1.3**

There are two types of information notices used in this manual. These notices highlight important information or warn the user of a potentially dangerous situation. The following notices will have the same level of importance throughout this manual:



---

Note: Indicates important information or helpful hints.

---



---

**WARNING:** Indicates the possibility of severe personal injury, loss of life or equipment damage if the instructions are not followed.

---

### Contact Information for Additional Technical Assistance

1.4

For further technical assistance for the BMSO unit, please do not hesitate to contact your nearest BRUKER dealer or contact us directly at:

BRUKER BIOSPIN GMBH  
Silberstreifen  
D-76287 Rheinstetten  
Germany

Phone: +49 721 5161 0  
FAX: +49 721 5171 01  
E-mail: [lcnmr@bruker-biospin.de](mailto:lcnmr@bruker-biospin.de)  
Internet: [www.bruker-biospin.de](http://www.bruker-biospin.de)



Figure 1.1. Declaration of Conformity



**DECLARATION OF CONFORMITY**

The under mentioned product

**BMSO H10052**  
**BRUKER MULTICOLUMN STOP-FLOW OVEN**

conforms to the main requirements  
set by the commission for the  
Harmonization of Regulations of the EU Member States  
with regards to electromagnetic compatibility  
(EMI 89/336/ECC) and safety (Low Voltage Electrical  
Equipment: 72/23/ECC) regulations.

For the assessment the following norms were applied:

EMI: EN 61326-1: 2001  
Test report: Nemko FS-0211-03947

Safety: EN 61010-1: 2<sup>nd</sup> ed. (2001)  
Test report: Nemko EL-0212-04078

Documentation: Z31705 Docu Standard: BMSO / Multicolumn Stop-Flow Oven

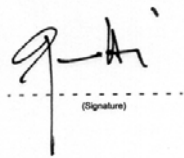
Manufacturer's Name: BRUKER BIOSPIN GmbH  
Manufacturer's Address: 76287 Rheinstetten, Silberstreifen,  
Germany

Declaration approved by:

Dr. Tonio Gianotti

Head of Development

Rheinstetten 18.05.2004



(Signature)



# Terms and Definitions

# 2

<b>BMSO:</b>	<b>Bruker Multicolumn Stopflow Oven</b>
<b>BNMI:</b>	<b>Bruker NMR-MS Interface</b>
<b>BPSU36-2:</b>	<b>Bruker Peak Sampling Unit</b>
<b>DAD:</b>	<b>Diodes Array Detector</b>
<b>EPP foam:</b>	<b>Expanded Polypropylene foam</b>
<b>Esquire:</b>	<b>Bruker Ion Trap MS System</b>
<b>Esquire 3000:</b>	<b>Successor to the Esquire</b>
<b>EWS:</b>	<b>Embedded Web Server</b>
<b>HPLC:</b>	<b>High Performance Liquid Chromatography</b>
<b>HyStar:</b>	<b>Bruker PC program controlling chromatography system and LC-NMR Interfaces BSFU, BPSU, BNMI, and SPE.</b>
<b>LC-NMR:</b>	<b>Combined HPLC and NMR analysis</b>
<b>MS:</b>	<b>Mass Spectroscopy</b>
<b>SPE:</b>	<b>Solid Phase Extraction</b>



# BMSO General Information

# 3

## Purpose

## 3.1

The BMSO is designed for HPLC-NMR applications and will be controlled by the HyStar software via Ethernet connection (**IP Address BMSO: 192.168.254.40**).

Several features have been implemented:

1. Mounting of six columns inside the heating chamber.

The possibility of selecting one of six columns via an HPLC Column selector system (see capillary wiring **Figure 6.13**).

Note: In the column system is the column No.6 and bypass, the six columns are col. 1-5 and column 7.

2. Full functionality of serial connection is only possible if two UV-cells are installed and a two channel DAD is used.
3. Heating or cooling of the columns.
4. Integration of one (or two optional) optical high pressure UV-cell(s) to detect a peak after the pre-column and after the selected main column.
5. Integration of an injection valve to inject and load chromatographic samples.

The BMSO is used in connection with the BPSU36-2 inside the MicroBay cabinet or as a standalone in a table rack.

## Acceptable Usage

## 3.2

The BMSO is designed for use in analytical chemistry research and development labs, as well as in universities for basic research.

The BMSO should always be installed in conjunction with a spectrometer system (NMR or MS) and is not for use in publicly-accessed areas.

The ambient temperature is defined by BRUKER (refer to the spectrometer site planning manual).

The BMSO may only be used in the LC-NMR cabinet (P/N W3003497) or in the standalone table rack (P/N W3004568).

The BMSO should only be operated by highly qualified personnel.

**BMSO Dimensions:**

Height: 132.5 mm  
Width: 19"  
Depth: 660 mm

**heating chamber Dimensions:**

Wide: 305mm  
Depth: 180mm  
Height: 33mm

**BMSO Weight:**

BMSO 21kg

**Operational Environment:**

5°C to 40°C non-condensing air humidity.

**Mains Voltage Line-In:**

Power Requirements: 110-230V  
50-60Hz  
Power Input (max.): 400VA

**Fuses:**

2 x 2.5A, 230V

**Main Pressure Input:**

Oil free dry air or N<sub>2</sub> max. 8 bar.

**Operational Pressure:**

2-3 bar.

**Cooling Medium:**

Only distilled water (maybe with an additive) max. input pressure 2 bar.  
Lowest temperature: maximum -10°C.



---

*The liquid used in HPLC may be dangerous for your health. Avoid skin contact and wear proper protection. The liquid in the BMSO is partially under high pressure. Be careful when opening connections and always wear eye protection.*

---



---

*Caution: UV radiation may be present at the outlet port and at the end of the light guide. Wear eye protection and do not look directly into the beam. Shut down the UV source if open any fiber optics loop.*

---



---

*If the cooling port is not in use keep the stop-cocks open. To avoid overpressure in the cooling fluid path, it is strongly recommended that you disconnect the tubes and flush the fluid after any cooling cycle (use of a cooling aggregate), before using the heating.*

---





# Preparation Before First Usage

# 4

## Overview of Location

4.1

The BMSO is used in 2 main configurations, in a standalone rack and inside a MicroBay cabinet rack with the BPSU36-2.

Typical installations as a standalone rack are shown in [Figure 4.1.](#), [Figure 4.2.](#), and [Figure 4.3.](#)

Figure 4.1. A Typical Installation without a LC-NMR MicroBay Cabinet

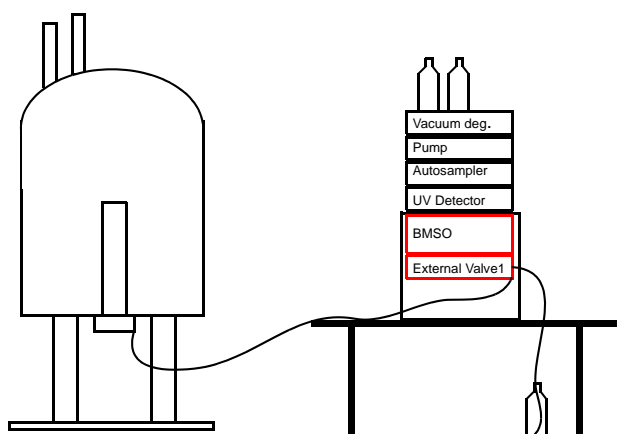
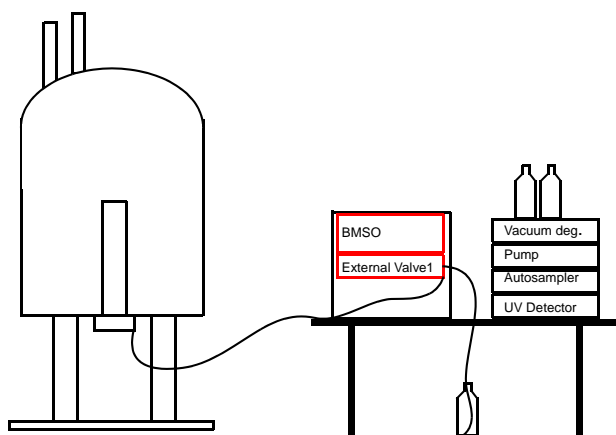
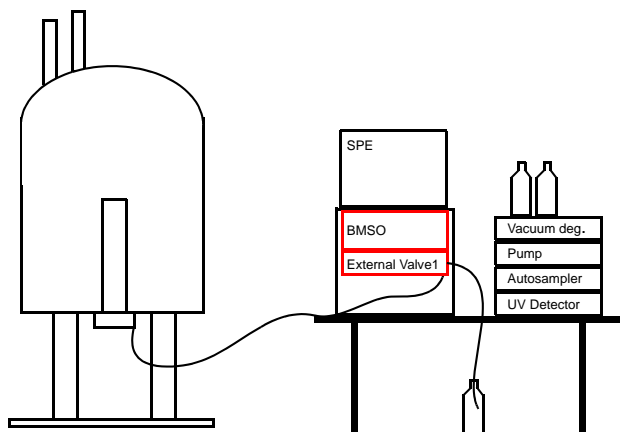


Figure 4.2. A Second Typical Installation without a LC-NMR MicroBay Cabinet.



# Preparation Before First Usage

Figure 4.3. A Typical Installation without a LC-NMR MicroBay Cabinet with SPE



Typical installations with a LC-NMR MicroBay cabinet are shown in [Figure 4.4.](#), [Figure 4.5.](#), and [Figure 4.6.](#)

Figure 4.4. A Typical Installation with a LC-NMR MicroBay Cabinet

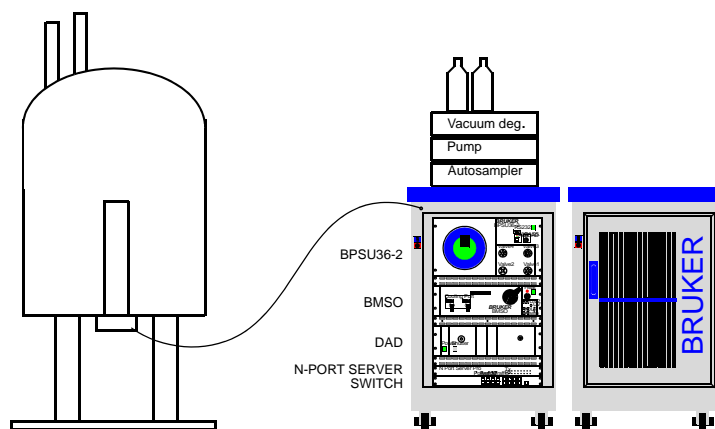


Figure 4.5. A Typical Installation with a LC-NMR MicroBay Cabinet and SPE

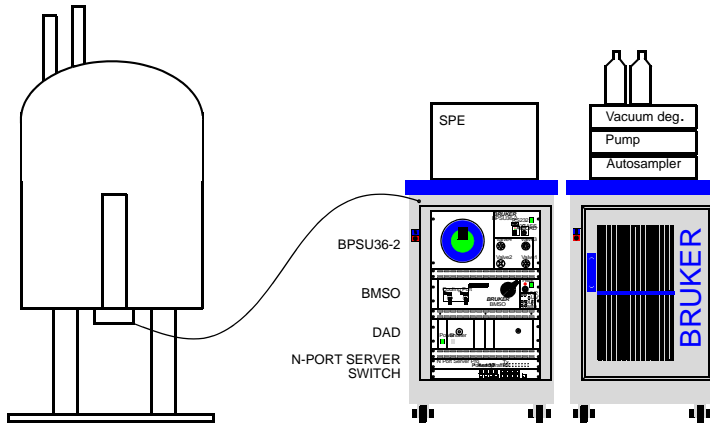
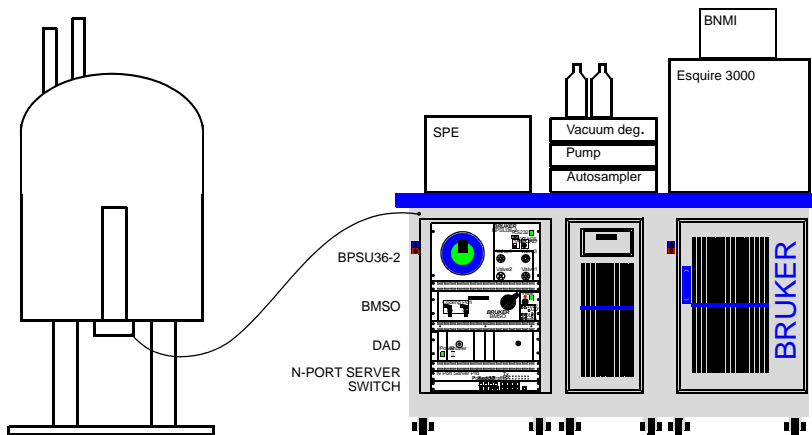


Figure 4.6. A Typical Installation with LC-NMR /MS MicroBay Cabinet and SPE



The BMSO is normally installed inside the standalone rack or inside the LC-NMR MicroBay cabinet.

The racks are shipped inside a wooden box. After unpacking the box please control the racks before removing them, to see if all the units are fixed inside the racks.



---

Keep the BMSO's transportation lock closed until the rack is in its final installation position. The BMSO should be placed as far as possible outside of the 5 gauss line of the magnet stray field.

---



---

Position the BMSO so that there is a short as possible length between the BMSO OUT and the NMR system.

---



---

**Before opening the drawer on BMSO remove the transport lock (see Figure 4.7.) on the front panel. Before ANY transport the transport lock must be installed again!**

---

Figure 4.7. Standard Racks

Standalone Rack



Transportation Lock

LC-NMR MicroBay Cabinet

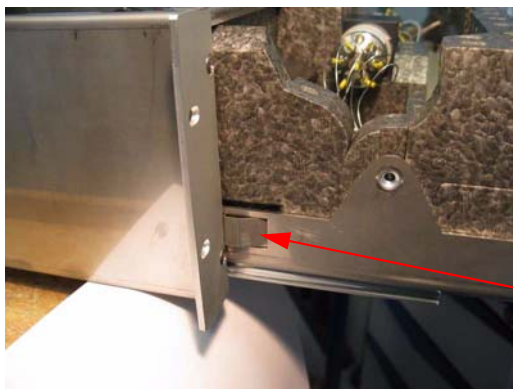


---

When opening the BMSO drawer there is an end position lock (see [Figure 4.8.](#)) which is used to fix the drawer in the open position. To close the drawer press the lock as shown in the figure below.

---

Figure 4.8. End Position Lock



Press the lock to close the drawer

## Preparation Before First Usage

### ***BMSO Assembly After Unpacking***

**4.3**

After unpacking the racks, the BMSO must be assembled with the ultraviolet (UV) cells, fiber optics and columns.

#### ***Install UV Cells***

**4.3.1**

To install the UV cells you need the following parts.

To install the UV Cell 1

1 x UV cell P/N 86009 (including 2 x hexagon socket screws M3 x 6)

3x fiber optics P/N 84266 variant 4 (400mm length)

1x opto adapter SMA/2mm P/N 85677

1 x capillary (OD1/16" / ID 0.125mm/ length 100mm) P/N 86326

To install the UV Cell 2

1 x UV cell P/N 86009 (including 2 x hexagon socked screws M3 x 6)

2 x fiber optics P/N 84266 variant 12 (1180mm length)

2 x fiber optics (for external connection) P/N 84266 variant 4 (400mm length)

2x opto adapter SMA/2mm P/N 85677

Unscrew one screw (**only one!**) from the separate front panel with the SMA connectors and capillary connectors, and remove the panel (pull away the lower side first).

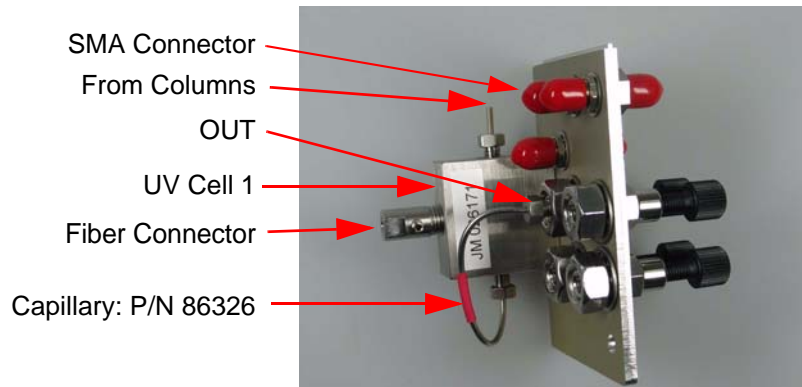


---

***THE FRONT PANEL WITH THE POWER SWITCH AND THE HEATER LAMP SHOULD NOT BE REMOVED. „BE CAREFULL THERE IS MAINS VOLTAGE PRESENT ON THE REAR SIDE“.***

---

Figure 4.9. UV Cell on the Front Panel



Unscrew only this screw and remove the panel

Place the UV cell 1 behind the right small front plate (use the two hexagon socket screws M3 x 6).

Take the capillary (P/N86326) from the accessory and connect it in the lower input of the UV cell. Bend the capillary and connect the other side to the front plate connector labeled (OUT). Take the capillary labeled OUT (coming from the columns) and connect it in the upper cell connector.

Take the 400mm length fiber optics and insert the 2mm metal frame side into the cell connector (internal) until the stop limit. Connect the other side into the front panel SMA connector (Cell 1).



When installing the fiber optics in the UV cell, please insert the 2mm metal frame side until the limit stop.

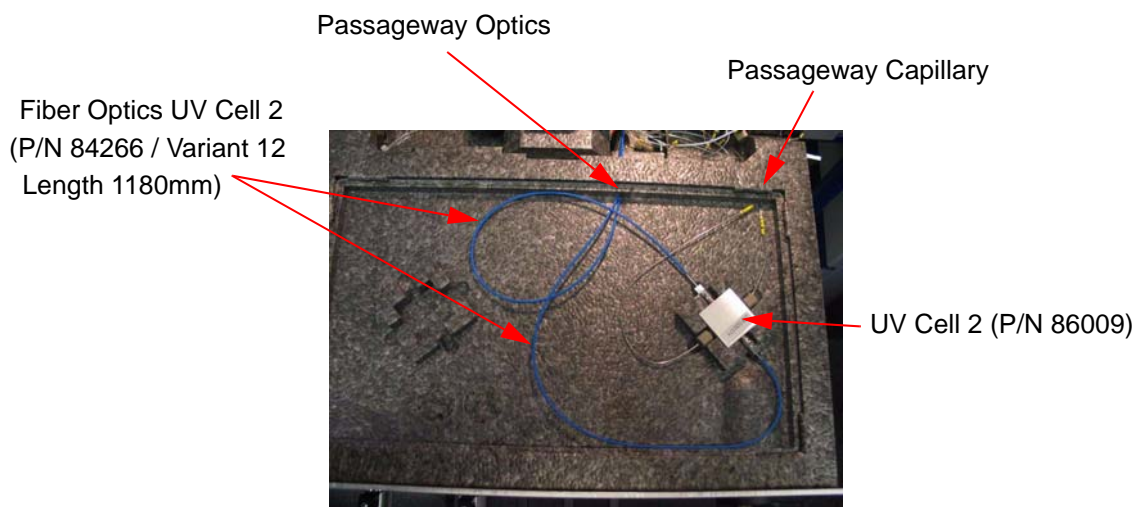


Tighten the two socket screws (on all 2mm optical connector sides) using slow torque.

The UV cell 2 (if used) is placed in a socket at the top of the heating chamber cover on the right side.

## Preparation Before First Usage

Figure 4.10. Location of the UV Cell 2



With this in mind, the cell should be placed in the direction as shown in **Figure 4.10.**

- Pull out the drawer and remove the acrylic glass cover.
- Take out the capillary connector at the top of the heating cover and replace it with the UV cell 2.

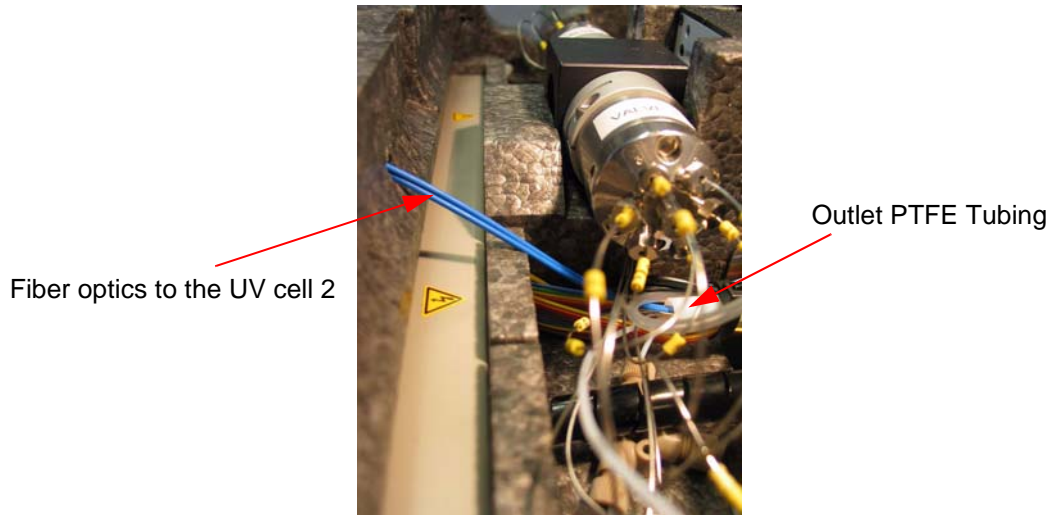
There are two optical cables (2 x fiber optics P/N 84266 variant 12 - 1180mm length) necessary for the connection of the UV cell 2.

One end of the fiber optics cable has an SMA connector, the other end a plain metal frame with a 2mm diameter. The length is 1180mm.

- Insert the fiber cables one by one with a rotating motion starting from the front plate side into the PTFE tubing. Two of these tubes are located inside the flexible cable guide. From the PTFE outlet insert the fiber cables into the heating room cover (see **Figure 4.11.**).

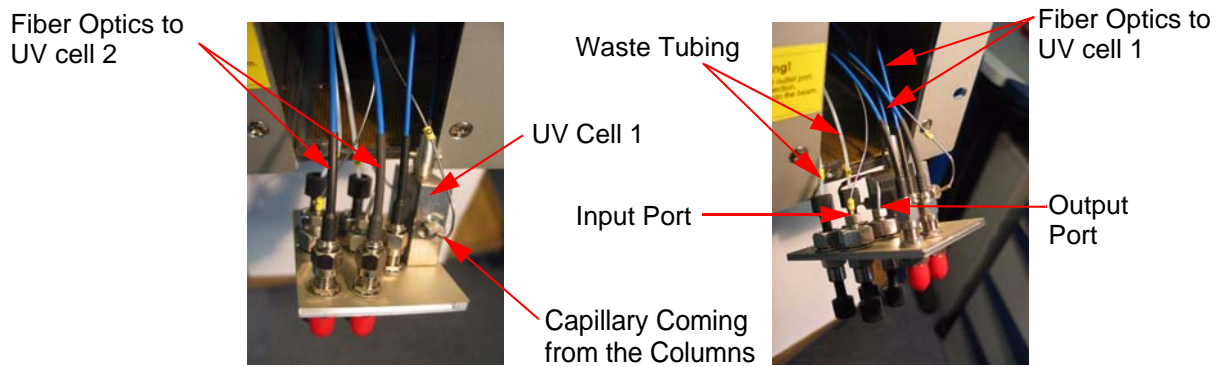


Figure 4.11. Fiber Optics to the UV Cell 2



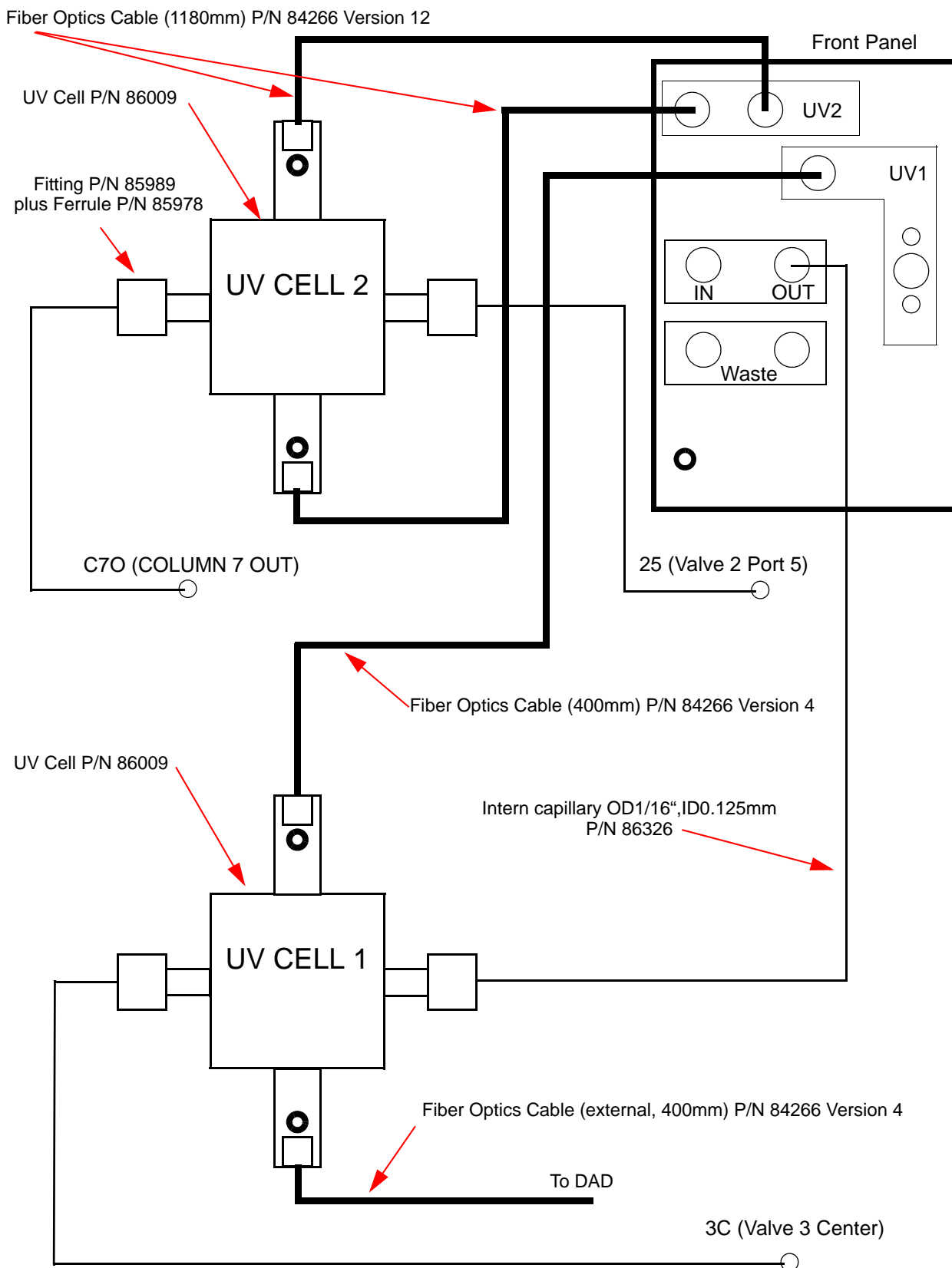
All fiber optics and capillaries should be placed in a stress free position.

Figure 4.12. Fiber Optics Connections on the Front Panel



# Preparation Before First Usage

Figure 4.13. Schematical UV Cell Wiring





---

Verify that the fiber optics are correctly fitted and that the radian is not too narrow. The 2mm end of the fiber cable should be inserted to the stop position in the UV cell, then carefully tighten the two hexagon socket set screws.

---



---

**Correctly Locking a Capillary Connection:** Take the end of the capillary and insert the fitting and the ferrule into the slot and tighten the fitting. While tightening be sure to press the capillary to the limit stop.

---

### ***Install Columns***

**4.3.2**

---

The next step in assembling the BMSO is to install the columns.  
Open the heater cover and install your column configuration.



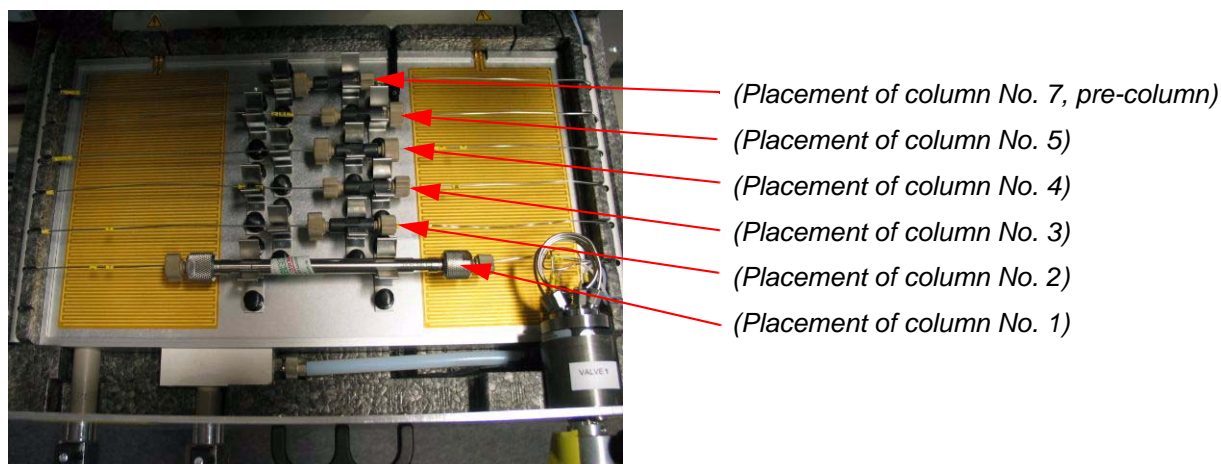
---

Refer to **Figure 4.14.** for the numbering of the columns which corresponds with the HyStar software.

---

## Preparation Before First Usage

Figure 4.14. Column Numbering in the BMSO



„Column“ 6 is a special case, whereas it is not possible to integrate a column in this path. This path is a bypass path (capillary connection between valve 3 port 6 and valve 4 port 6). This capillary does not lie inside the heating chamber but rather behind them.

### ***Nomenclature of the Capillary Numbering***

Labeling (yellow labels on capillaries) of all capillary connections are follows:

- All capillary connectors have a yellow label which correspond with the capillary connection plan, see ***Figure 6.13***.

Example of a **valve** connection number:

- If a capillary connector has a yellow ring with number 25 it means **valve 2 port 5**.

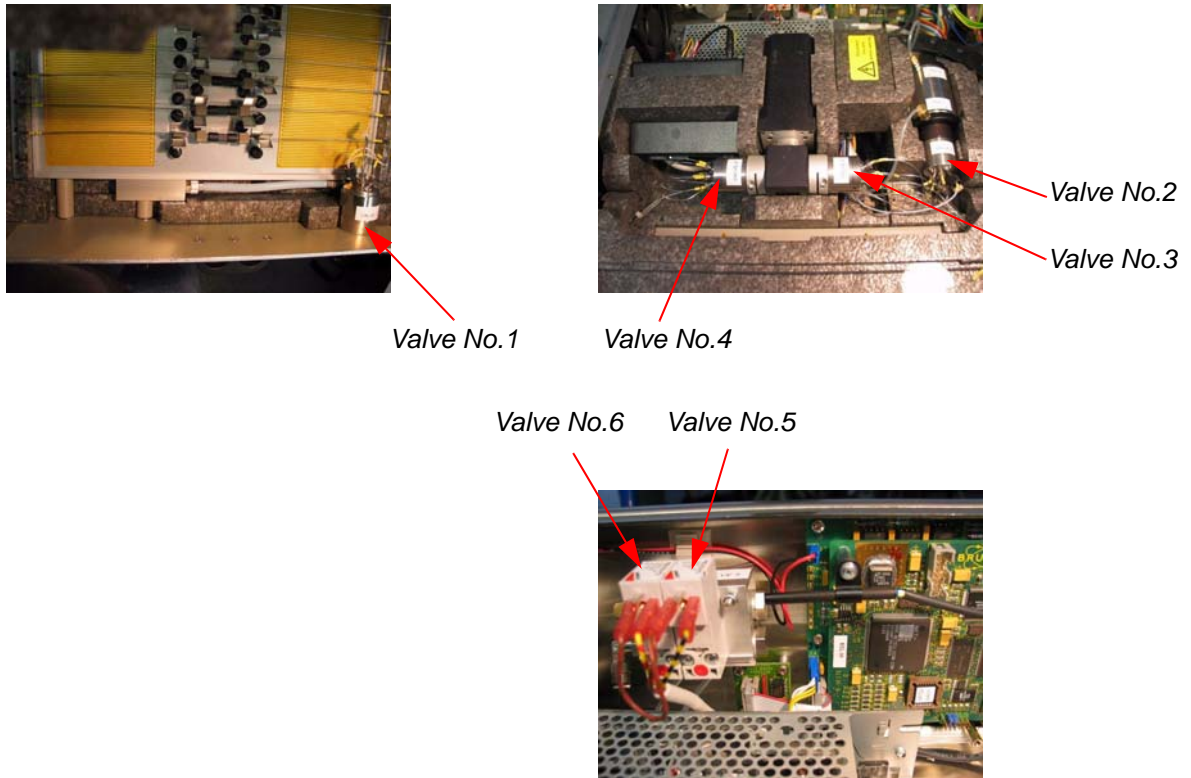
Example of a **column** connection number:

- If a capillary connector (on column) has a yellow ring with number 31 it means **column No. 3 In** or when the connector has a ring with 40 it means **column No. 4 OUT**.

### ***Nomenclature of the Valve Numbering***

All valves in the BMSO are numbered as shown in ***Figure 4.15***.

Figure 4.15. Valve Numbering



## Installing the BMSO Waste Capillaries

### 4.3.3

At the front panel, on the right side, are two capillary outputs to connect the BMSO to the waste bottle see [Figure 4.16](#).

To connect the BMSO to the waste bottle, take the PTFE capillary (P/N 69011) with a 0,5mm internal diameter (for the capillary look in the accessory package) and connect one end to the BMSO waste connectors, and insert the other end into an waste bottle.

Figure 4.16. Waste Connector on the Front Panel

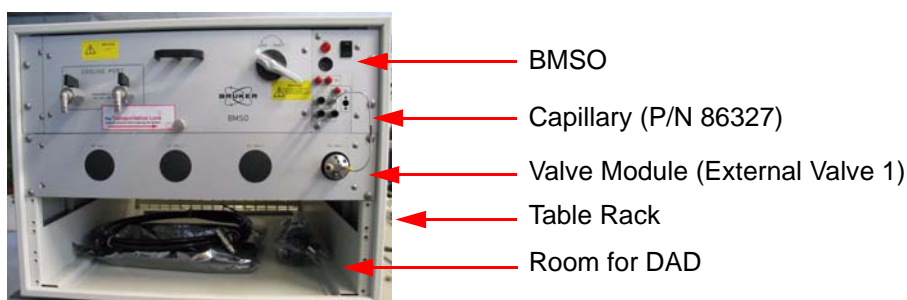


By now the columns, UV cells and fiber optics should be installed inside the BMSO.

Before using the BMSO for the first time, you need to do install all the external parts.

If using the BMSO in the LC MicroBay rack refer to **"Initial Connections to the MicroBay Cabinet" on page 29**. If using the BMSO in the standalone rack, refer to the following steps.

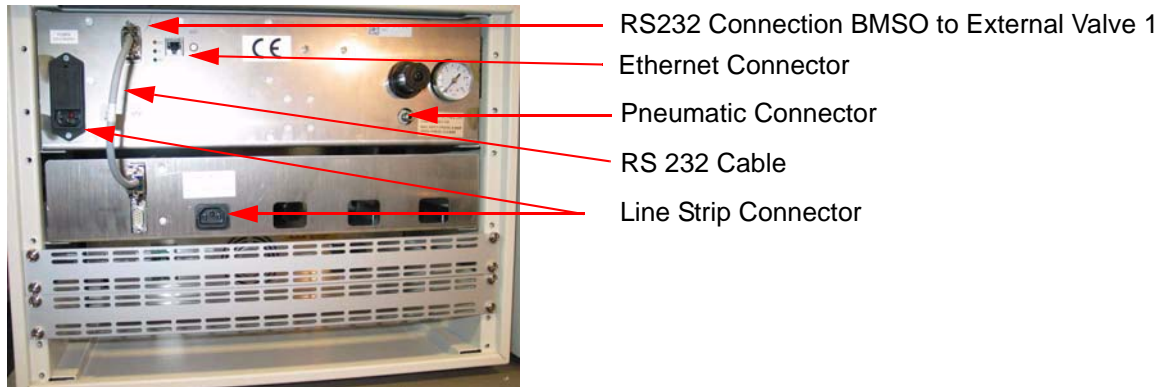
Figure 4.17. BMSO Standalone Table Rack Front View



#### Installing the External Parts

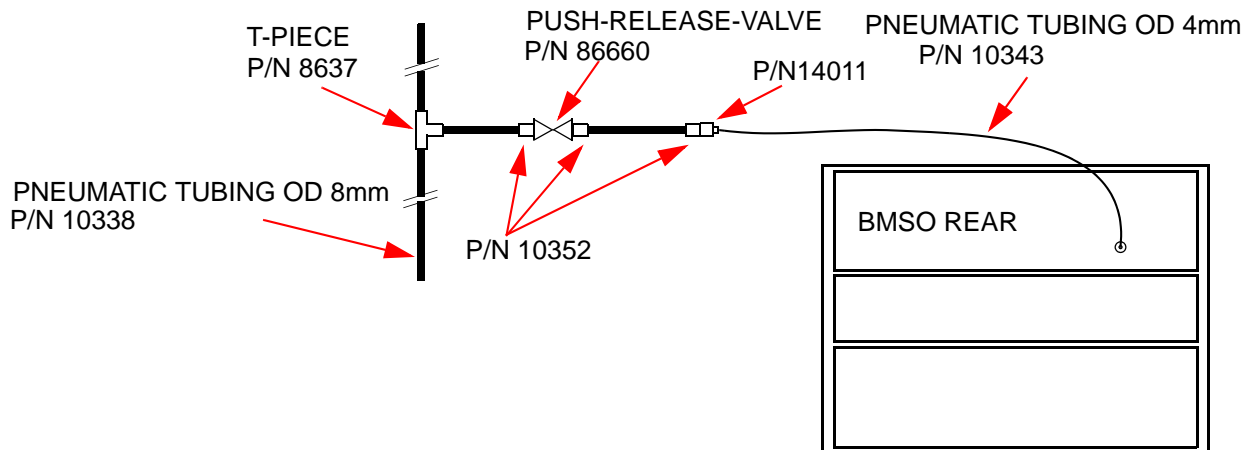
- Connect the fiber optics cable (P/N 84266, version 4, 400mm length) from the UV source (DAD) to the UV cell 1 and an additional fiber optics cable (same type 400mm) from UV receiver to the UV cell 1.
- Connect the capillary (see accessory pack P/N 86497) from the BMSO OUT to external valve 1 port 1.
- Close the external Valve 1 Port 3 using the plug fitting (P/N 67398).
- Connect the waste capillary (PTFE tubing with 0.5mm internal diameter) from external valve 1 port 2 to the waste bottle.
- Connect the capillary from the external Valve 1 Port 4 to the NMR Probe.
- Connect the IN connector on front plate to the PUMP.
- Connect the short RS232 connector cable from the BMSO **RS232 OUT** on the rear side to the external valve 1 **RS232 IN**.
- Connect the Ethernet cable from the BMSO to the SWITCH/HUB.
- Connect the pneumatic tubing (OD 4mm see **Figure 4.19.**) to the BMSO rear side.
- Connect both power lines (BMSO and external valve 1).

Figure 4.18. BMSO Standalone Table Rack Rear



All necessary parts for the pneumatic connection of the BMSO are inside the installation kit (P/N H10157).

Figure 4.19. BMSO Standalone Pneumatic Connection



### Initial Connections to the MicroBay Cabinet

4.5

Connect the MicroBay line strip.

Connect the pneumatic tube to the rear panel („ONLY N<sub>2</sub> OR OIL FREE DRY COMP. AIR“ max. input pressure 8 bar) see **Figure 4.22**.

Connect the Ethernet from SWITCH/HUB to the rear panel („ETH1“).

Connect the capillary (P/N 86498) from the BMSO OUT to the BPSU36-2's valve 4 port 2.

Connect all the external fiber optics as discussed in the section **"Initial Connections to the Standalone Unit" on page 28**.



# Preparation Before First Usage

Figure 4.20. MicroBay Cabinet Front View

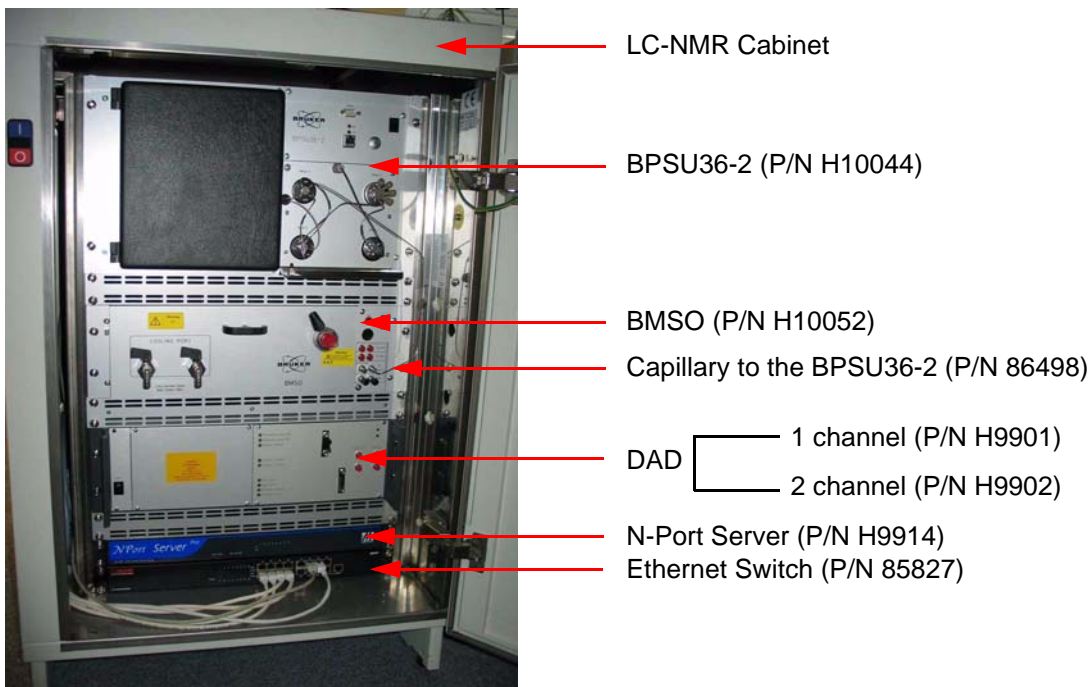
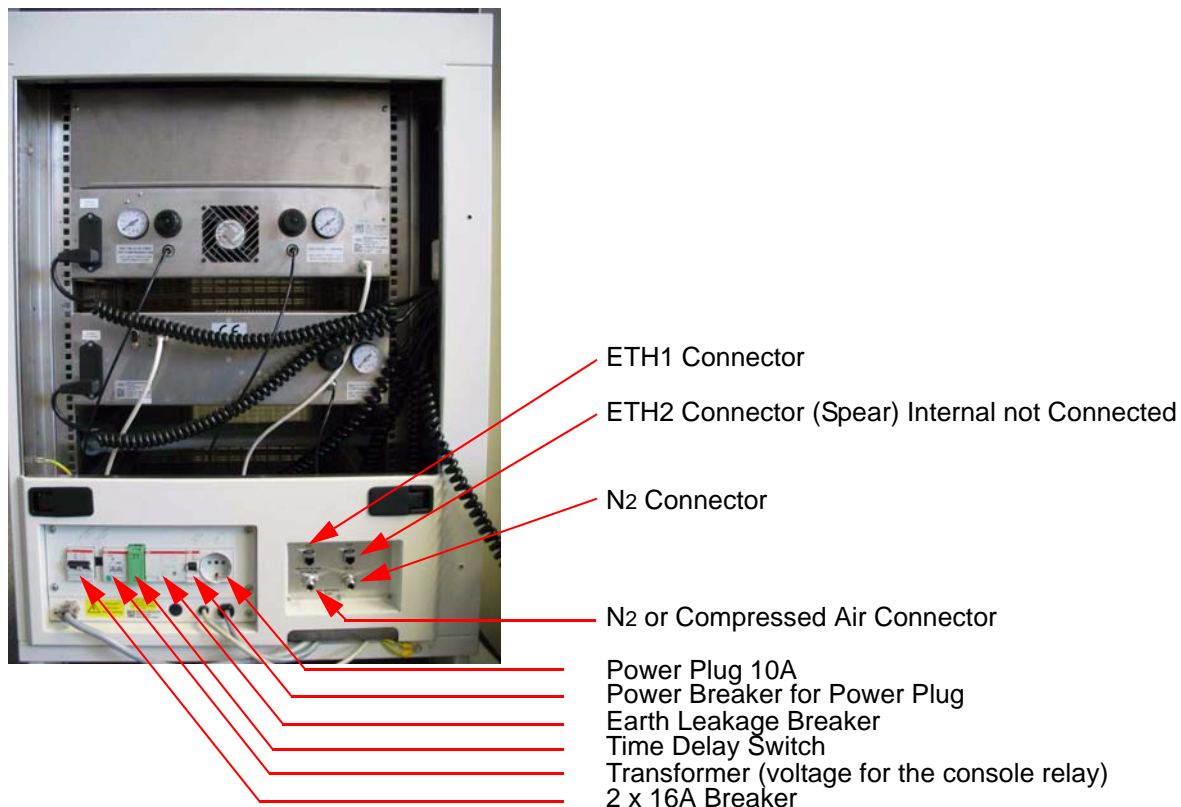


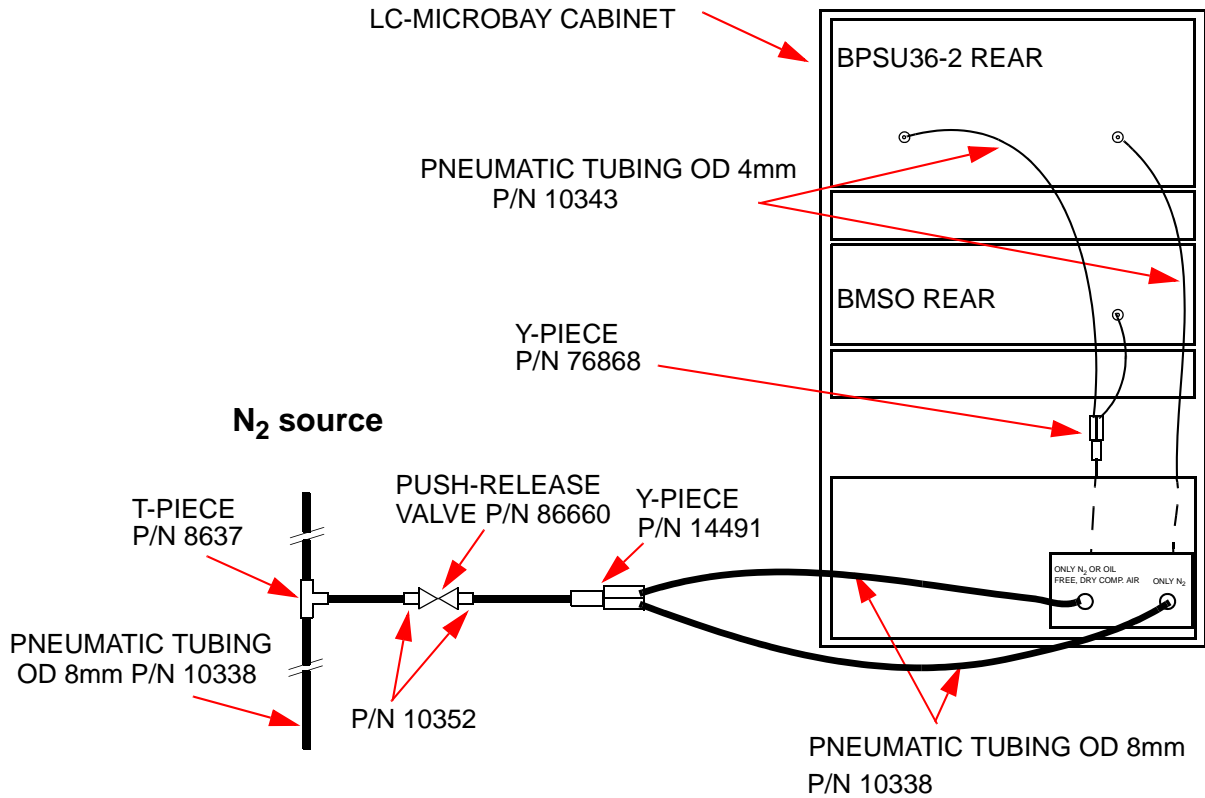
Figure 4.21. MicroBay Cabinet Rear View



If the system operates only with the N2 connected to the pneumatic as shown in **Figure 4.22**.



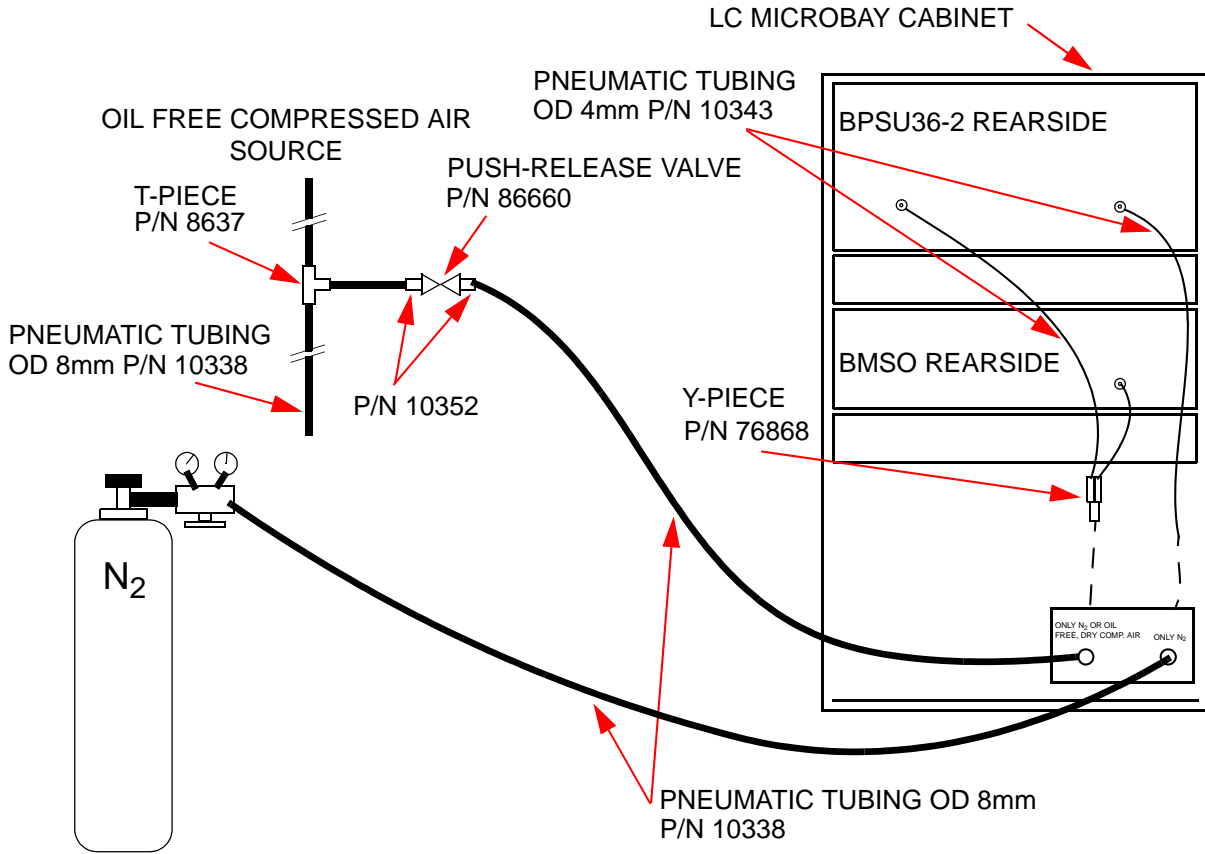
Figure 4.22. BPSU36-2/BMSO Pneumatic Connection (only N<sub>2</sub>)



If the system operates with compressed air and N<sub>2</sub>, connect the pneumatic as shown in [Figure 4.23](#).

# Preparation Before First Usage

Figure 4.23. BPSU36-2/BMSO Pneumatic Connection (N<sub>2</sub> + Comp. Air)



# Operating Instructions

# 5

## Functional Description

## 5.1

One of the main functions of the BMSO is to house up to 6 columns inside the oven (different diameter and different length are possible). The adjustable temperature range provides ambient temperature up to 80°C in steps of 1°C, with an accuracy of +/- 1°C.

To place a column in the oven, move out the drawer and open the heating chamber cover and place up to 6 HPLC columns in the column holder. The oven should not be used for any other device, only HPLC columns should be admitted. The columns are fixed in place by two snap clips per column.

The heater module consists by an aluminium block that has a bonded heating foil on the bottom. This heating foil is operated through the mains power and is switched ON/OFF by two solid state relays. To prevent accidental damage from overheating, two thermal switches (switch point 110°C) are mounted on the right and left side of the heating foil. When a thermal switch is activated, the heating foil switches off until the foil cools down to about 70°C, whereas it will automatically switch on again.

An additional feature of the BMSO is the ability to cool the heating chamber. To achieve this, the aluminium plate has 12 serial connected holes, whereas the queue starts and stops at the two stop valves on the front panel.

The system measures the temperature at two points: the air temperature inside the heating chamber (see [Figure 5.11.](#)), and the temperature inside the aluminium plate.

The BMSO electronics detect leakages from capillary connections inside the heating chamber or from the capillary connections behind the right front plate (see [Figure 5.1.](#), [Figure 5.11.](#)).

The closed position of the drawer is detected through use of a switch located inside the BMSO. When the drawer is not closed tightly, it is not possible for the heater electronics to switch on the heater foil.

When the heater foil is switched on the red light on the front panel is on too.

The existence of an injection valve (with 100µl sample loop) supports the manual injection of a probe in the system. In the LOAD position the probe can be manually filled in the sample loop. A sensor will detect when the valve is moved into the inject position and will report this to HyStar. The HyStar software can use this as a start signal to trigger the data acquisition.

The BMSO uses two UV cell's, located at the main columns (cell no. 1) and at the precolumn (cell no. 2), to measure the UV absorption peak. The placement of cell 1 is behind the right front panel of the main columns; the placement of cell 2 is at the top of the heating chamber cover.

## Operating Instructions

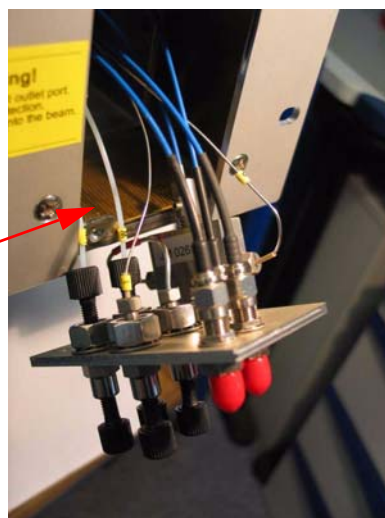
Located inside the BMSO is an electrically powered column selection valve, which can switch one of six columns in the main flow path (an exception is column no. 6, then a normal capillary is installed as a bypass in place of the column).

The BMSO also has a pneumatic powered, two position, 3L valve which is used to either switch the precolumn (column no.7) in the flow path, or to bypass them. This valve is controlled by two pre-control valves which are mounted on the back panel beside the controller board.

For an overview of the capillary and valve connections see **Figure 6.13**.

*Figure 5.1. Location of the Leak Sensor behind the Front Plate*

Leak sensor behind the front plate



## Optional Cooling Port

5.2

The cooling port is a mechanical feature inside the BMSO used to connect a cooling aggregate (see [Figure 5.2](#), [Figure 5.3](#), [Figure 5.4](#)).

The choice of which cooling aggregate is used, as well as the connection used, and the maintenance of such an cooling aggregate is the responsibility of the customer and is not supported by BRUKER.



### Specs Cooling Port:

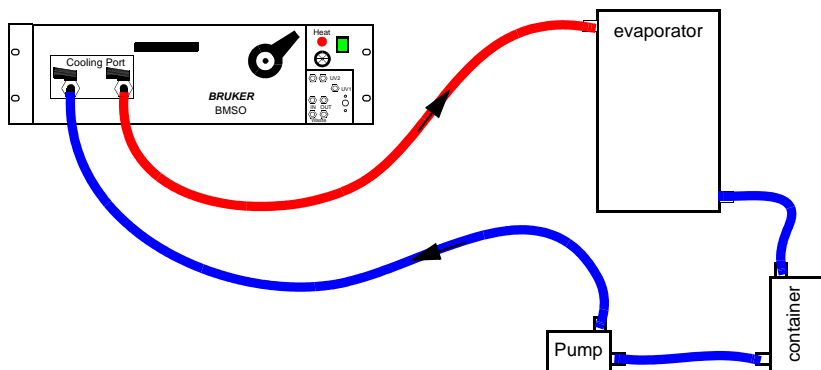
Cooling medium: Use only distilled water with a maximum input pressure of 2 bar. There is no restrictions on which stop valve is used as input.

## Cooling Recommendations

5.2.1

If you need to cool the heated plate in a short time down to ambient temperature, you can use a cooling system which is used normally in PC Systems [Figure 5.2](#).

Figure 5.2. Cooling System Connections



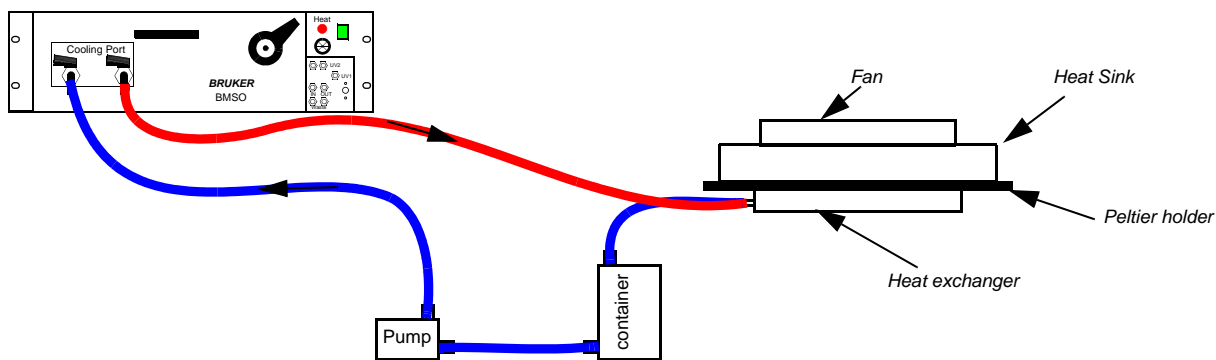
# Operating Instructions

If you need to cool the heating chamber to temperatures under the ambient temperature, you will need an active cooling aggregate (see **Figure 5.3**).



When the temperature decreases, condensed water will collect inside the heating chamber and may cause leaks or sensors to set off an alarm.

Figure 5.3. Peltier Cooling Aggregate



An advanced cooling system for the BMSO consists of an aggregate with a compressor as illustrated in **Figure 5.4**. (example: [www.thermoneslab.com](http://www.thermoneslab.com)).

Figure 5.4. Recirculating Chillers

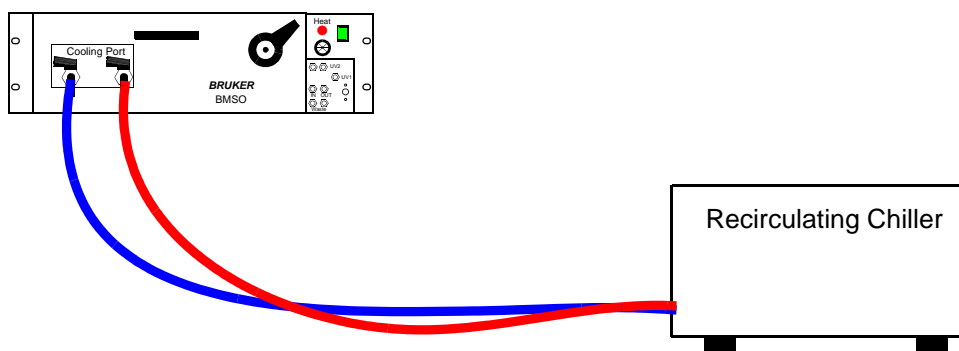


Figure 5.5. Caution Concerning UV Radiation

If the fiber optics has an open end or connection do look not into the beam. Eye protection should be worn.



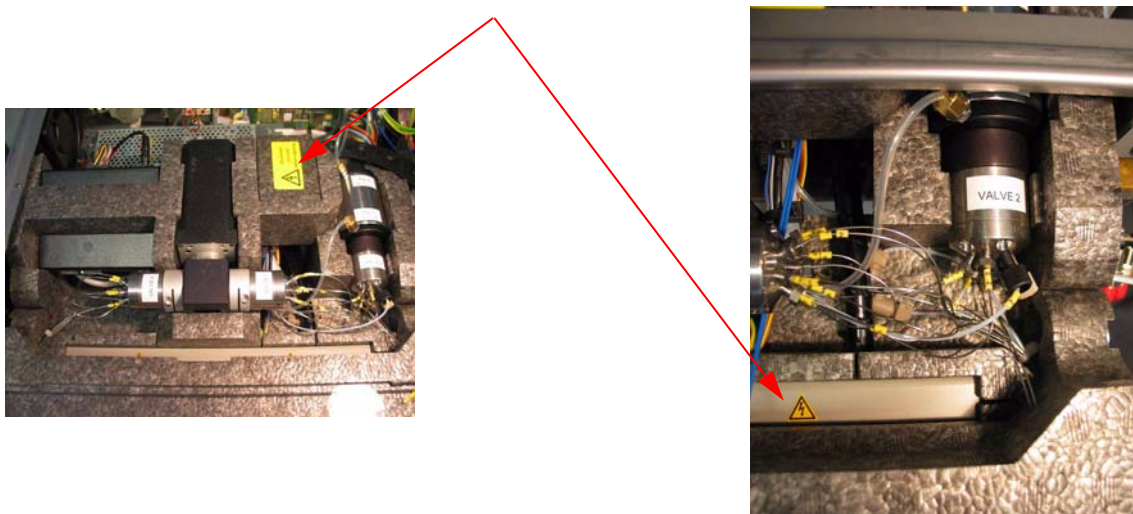
Figure 5.6. Caution Concerning Hot Parts and Liquids

This label warns that hot parts and/or liquids may be present. Do not touch any parts or liquids inside the heating chamber when the unit is in use.



Figure 5.7. Caution Concerning High Voltage

Indicates presence of high voltage (under the cover).

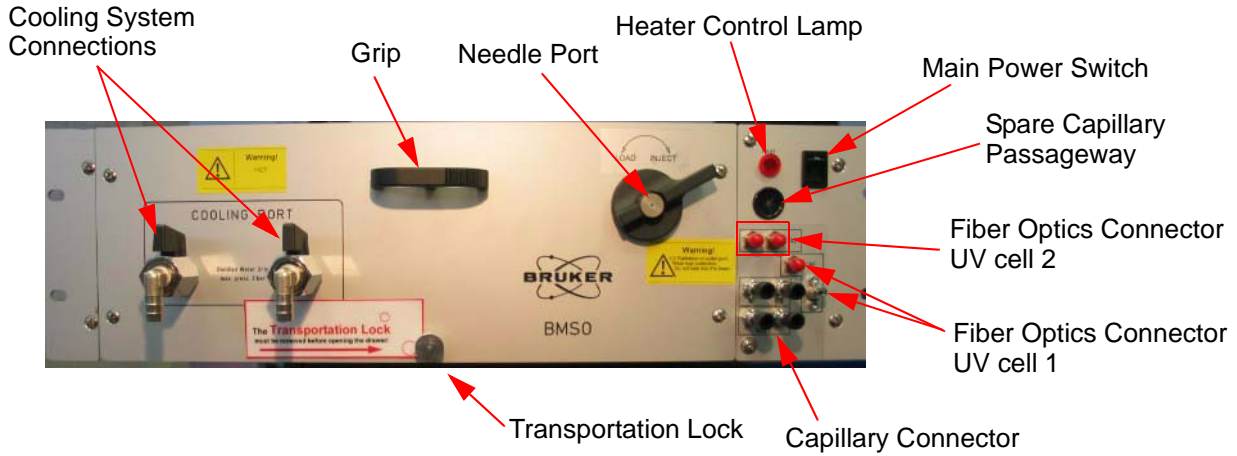


# Operating Instructions

## Front Panel Connections

5.4

Figure 5.8. Location of the Front Panel Connections



## Rear Panel Connections

5.5

Figure 5.9. Location of the Rear Panel Connections (electrical)

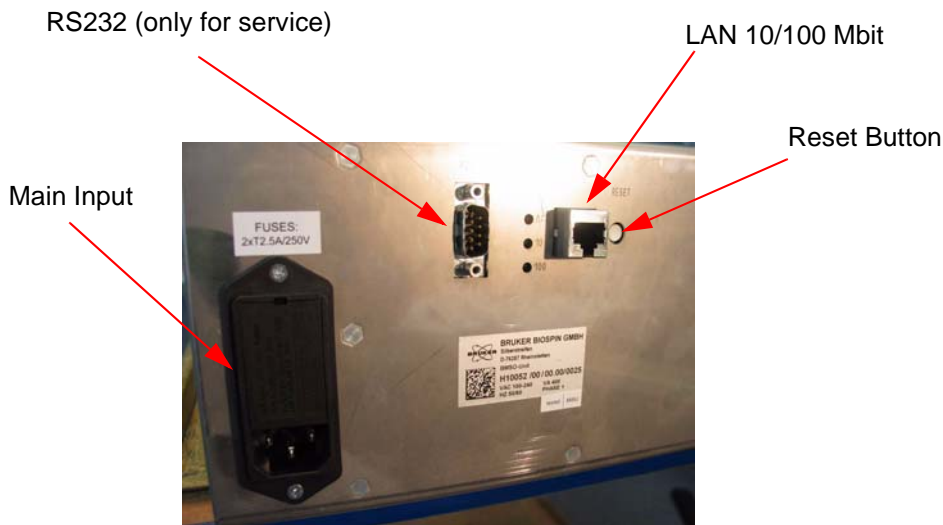
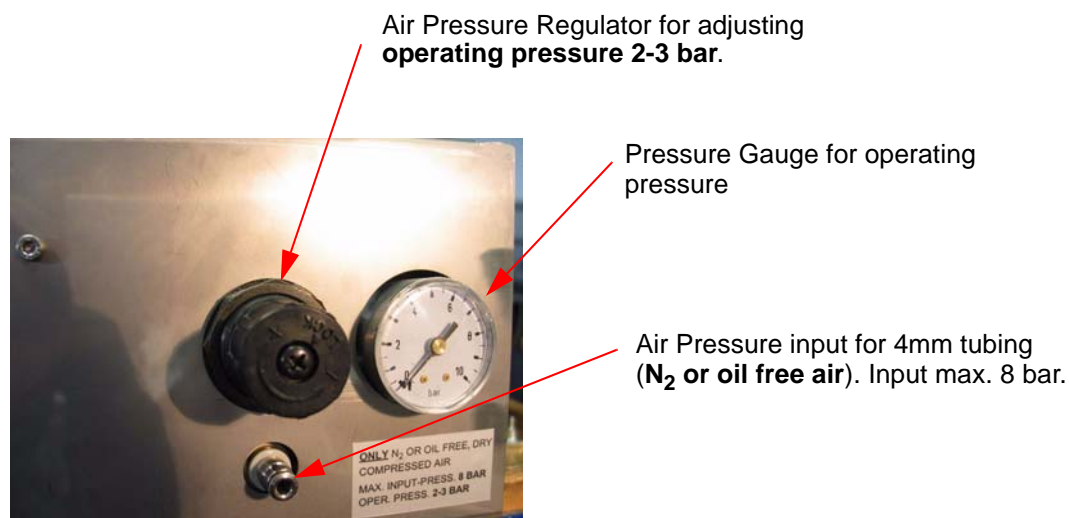




Figure 5.10. Location of the Rear Panel Connections (pneumatic)



### The Heating Chamber

### 5.6

The heating plate contains leak sensors, located on both sides, which detect leaks in the heating chamber.

When a leakage is detected, a warning is initiated from the HyStar software.

After repairing the leakage the contaminated area should be thoroughly cleaned until the warning is suppressed in the HyStar software. The column holder can be removed by lifting up the two black knobs.

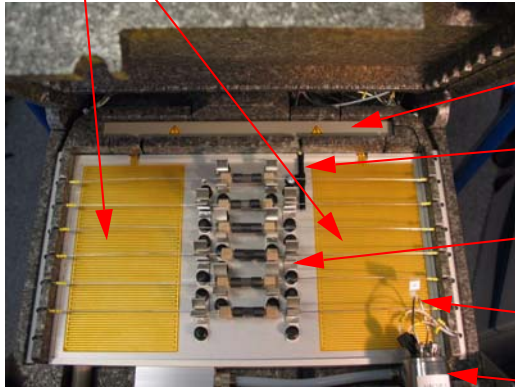


***The cable trench cover should not be opened as there is high voltage present inside.***

# Operating Instructions

Figure 5.11. Location of Sensors, Column Holders, Cable Trench Cover

Leak Sensors



Cable Trench Cover

Temp. Sensor (air heating chamber)

Column Holder

Sample Loop (100ul)

Injection Valve (Valve No.1)

## The Rear Chamber

5.7

Figure 5.12. Location of Boards and Power Supply

Valve block used to switch the 6 port/3L/2 position valve

BMSO Control Board

100MB Ethernet Board

BIS Board

PT100 Temperature Sensor

Power Supply

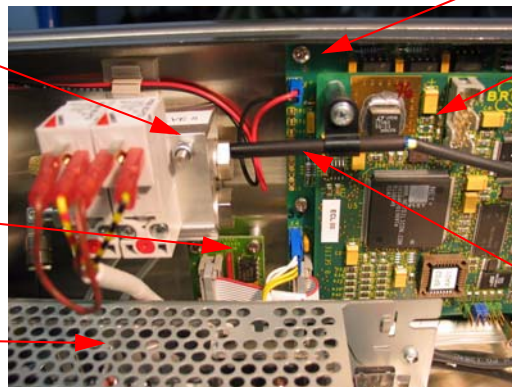
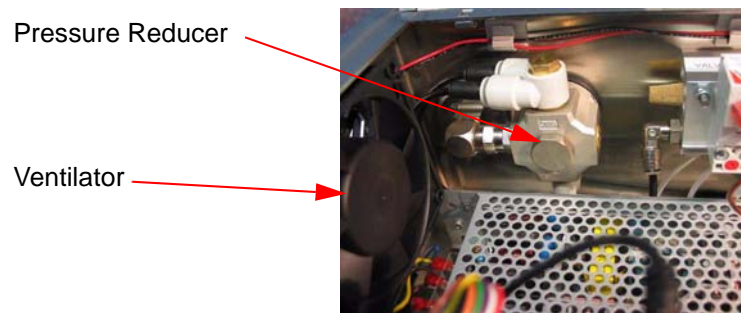


Figure 5.13. Location of Pressure Reducer and Ventilator inside BMSO



## Valve Numbering

5.8

Each valve is numbered for reference in the tubing wiring plan.

1. Valve No.1 - Injection valve in front plate.
2. Valve No.2 - 6Port/3L/2 position valve (right side).
3. Valve No.3 - Column selection valve (right).
4. Valve No.4 - Column selection valve (left).
5. Valve No.5 - Valve block on rear panel (right valve on block).
6. Valve No.6 - Valve block on rear panel (left valve on block).



***The protective cover should only be opened for service. In this case it is imperative that the mains power cable is disconnected.***

# Operating Instructions

Figure 5.14. Location of Valves No. 2,3, and 4

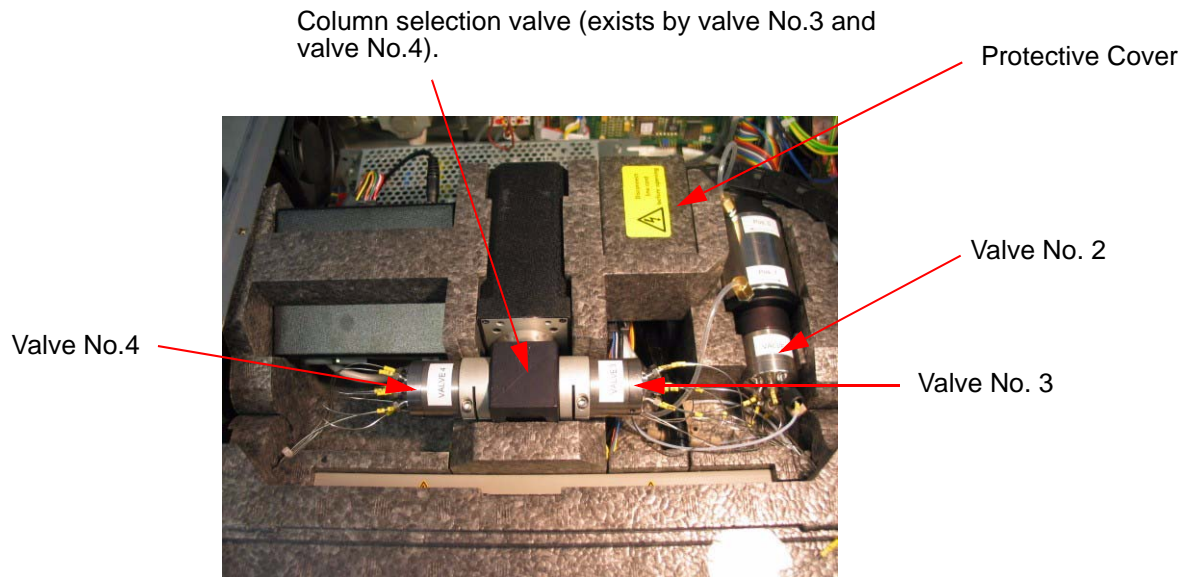


Figure 5.15. Location of Valve No. 1 (Injection Valve)

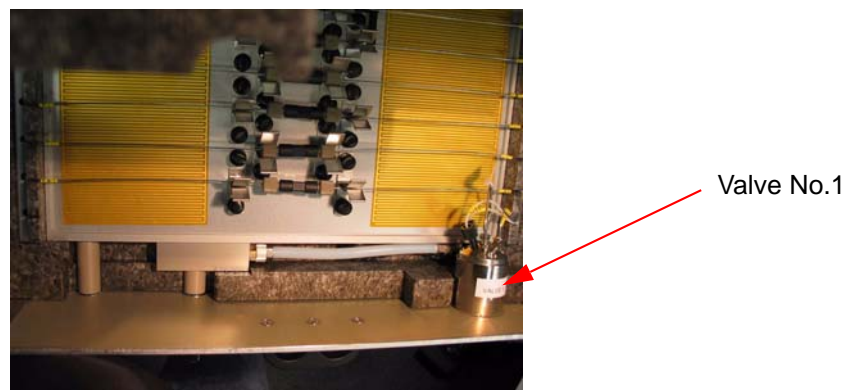
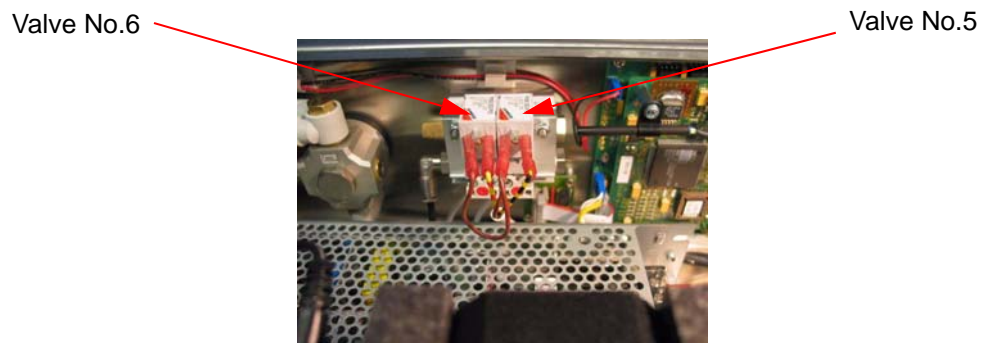


Figure 5.16. Location of Valves No. 5 and 6







---

**Main Power Cable:** The mains power cable must be removed before opening the unit (cover), when pulling out the drawer past the first lock (see "Drawer Handling During Servicing" on page 48) or when removing the front panel (the panel with the mains switch and heater lamp).

**Solvents:** Liquids used in chromatography (e.g Acetonitril, Methanol, etc.) are extremely hazardous. Proper skin and eye protection must be worn, and contact and inhalation must be avoided. Take care when opening capillary connections, as liquids may be pressurized.

**Protected Mains Ground:** The mains ground connection to the unit is supplied via the largest pin in the Euro-Standard 3 pin connector. This must be connected to the ground using either the mains cable supplied, or one with similar specifications. Incorrect grounding of the unit can be very dangerous.

**Cooling:** The air flow through the cabinet must not be obstructed. Make sure that the front and rear air passageways are not blocked!

**Fire hazard:** Handle the unit carefully when heating above 40°C - do not touch any parts inside the oven. The parts inside the oven maintain this temperature for a long time after the heater is switched off.

**Transport:** Before transporting the BMSO the transportation lock must be installed.

**Cleaning:** To prevent electric shock do not clean in the region of the mains switch or mains connection cable without first disconnecting the mains cable from the rear of the unit.

---

The parts accessible from the front of the valve module are resistant to typical solvents used in HPLC. These parts may be cleaned with a cloth moistened with water, methylated spirit etc. When the leak sensor is damp the unit will indicate a leak, whereas this must be dried thoroughly with a dry, lint-free cloth. This can be done with the unit powered-on and showing the status display, whereas the state of the leak sensor can be monitored.



---

The BMSO parts that come in contact with liquids are made of glass, stainless steel, Kel-F, PTFE and PEEK. Solvents which are used in analysis, or for flushing the system, should not be corrosive to any of these materials.

---

The HPLC column selector valve, the 6 port 3L 2 position valve, and the injection valve are not user serviceable. In case of malfunction, replacement or repair should only be carried out by trained Bruker service personnel. When a leak is detected, the user may check the fittings and tubing, and clear any blockages.

Before **each use** check all the capillary connections inside, and especially those outside the oven, as these connections have no leak sensors.

The air fan in the unit should be checked **annually** to ensure that the airflow through the unit is not obstructed. Make sure that the fan is not blocked or contaminated. To perform this check **disconnect the mains power cable**, remove the BMSO from the rack, and open the cover.



---

When using the cooling port for the first time it is necessary to check all the cooling port connections and seals around the heating plate to be sure that no cooling liquid is escaping.

---



- If the BMSO has not to used for a longer period of time, you will need to flush all the capillaries with a cleaning solvent to remove any salts or waste before using the unit.
- After using the BMSO flush the unit with a cleaning solvent to remove any salts. The flushing liquid used should be compatible with the actual solvent composition.
- The BMSO can be stored filled with liquid after use, however, a clean salt-free solution with high organic content (for example, water with 80% acetonitrile) must be used to avoid bacterial growth.

## Replacing Fiber Optics Cables

### 6.2

There are one fiber optics cables inside the BMSO (optionally three, if two UV-cells are installed). Two of the optical cables and two additional capillaries are located inside a PTFE protection tube. Two of these tubes are located inside the flexible cable guide. One end of the fiber optics cable has a SMA connector, the other end a plain metal frame with a 2mm diameter.



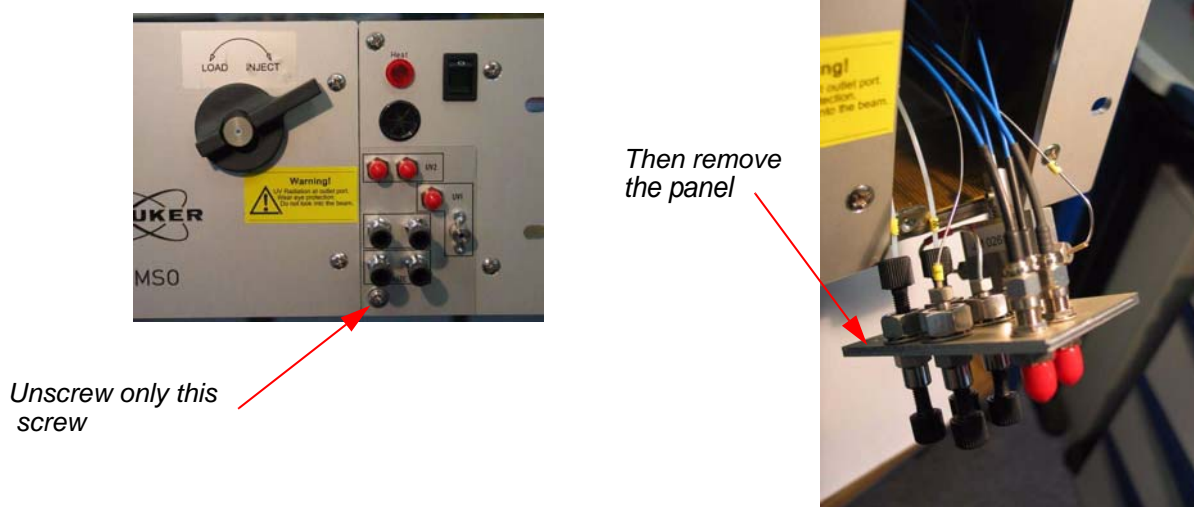
**THE FRONT PANEL WITH THE POWER SWITCH AND THE HEATER LAMP SHOULD NOT BE REMOVED AS THERE IS MAINS VOLTAGE PRESENT AT THE REAR SIDE OF THE PANEL.**

When it is necessary to replace a fiber optics cable the following procedure should be observed:

1. Unscrew one screw (**only one!**) from the separate front panel with the connected fiber optics.
2. Remove the panel and disconnect the damaged fiber optics cable (rear side the panel 5/16" hex nut).
3. Pull out the drawer and remove the acrylic glass cover, then unscrew the other side of the corresponding fiber optics cable.
4. Grasp the fiber optics cable on the front panel side (SMA connector) and pull out with a rotating motion.
5. Repeat the procedure in reverse to install the new fiber optics cable.
6. Verify that the fiber optics cables are correctly fitted and that the radian is not too narrow.

## Service Information

Figure 6.1. Removing the Port Front Panel



### Drawer Handling During Servicing

6.3

If a valve or capillary needs to be replaced during a service, it is possible to pull out the drawer in various intervals.

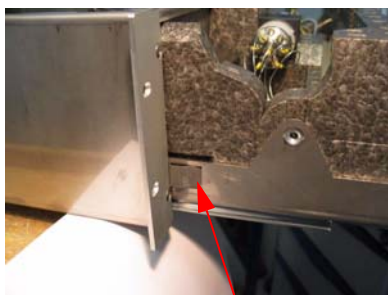
The standard interval (340mm) is reached when you pull out the drawer until it locks in place. This interval is normally used for handling the columns inside the heating chamber.

The next interval (400mm) is obtained when you press the unlock clip [Figure 6.2](#) on the left side the drawer and pull the drawer until it stops. This interval is necessary in order to access the valves and capillaries.



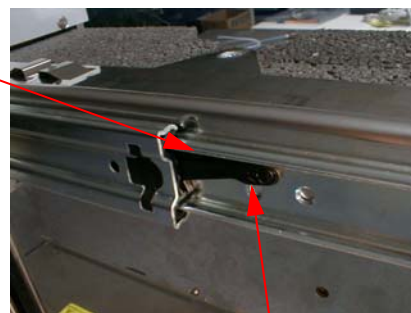
**The maximum interval length (~560mm) is possible if you unlock the black plastic lever at the bottom side of both drawer guides. This should be done only when the BMSO is out of the rack and placed on a stabilized table so that the drawer does not fall down. In this case it is possible to pull the drawer out of its traverse, whereas the only connection remaining between the case and drawer is the cable chain.**

Figure 6.2. Unlock the Drawer



Drawer lock in the normal out position

Unlock the drawer by moving the black plastic lever (on both sides) to the left.



Press to the left

**Warning!** Unlock the drawer only when the BMSO is on a stabilized table!

### Using the Correct Ferrules and Fittings

6.4

In the BMSO are several different ferrules and fittings used.

Two different injection valves have been installed in the BMSO. When the BMSO was first produced the valve used was from Rheodyne. This valve has since been replaced with a valve from Vici (both valves are functionally identical). The main difference between these valves are the special ferrules which are used for the Rheodyne valve.

For the Rheodyne valve capillary connection you can only use the special ferrules, adapter peek tube, and 100µl sample loop shown in **Figure 6.3.**

Generally when a 1/32" SS capillary is connected with a SS ferrule and nut, you will need a peek adapter tube to ensure a safe connection. (see **Figure 6.3.** and **Figure 6.7.**).

#### Rheodyne Valve Fittings

6.4.1

When installing the Rheodyne valve, you must use the 100µl sample loop (P/N 86049).

- To connect the 1/32" SS capillary, use the Rheodyne compatible ferrules and PEEK adapter tubes.
- To connect the PTFE waste tube, use the PEEK fittings and ferrules (P/N 69908).

# Service Information

Figure 6.3. Rheodyne Injection Valve and Fittings with Steel Capillary

Rheodyne Injector Valve



100µl Sample Loop  
only for Rheodyne  
valves P/N 86049

Special Ferrule (only for Rheodyne valves)  
(Visible on his ladder)



Adapter Peek Tube  
OD 1/16", ID 0.04"  
P/N 86119

Nut + Ferrule P/N 69908

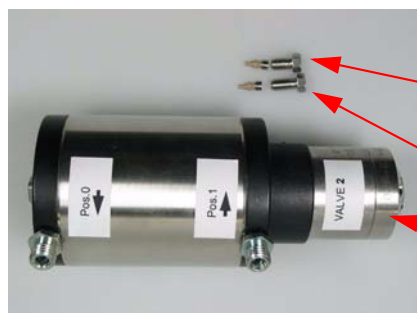
## Vici Valves Fittings

6.4.2

All Vici valves are connected with 1/32" (outer diameter) stainless steel capillaries using the nuts and ferrules as shown in **Figure 6.4.**

The nut which connects to the valve center is a little longer than the others, which makes it easier to handle.

Figure 6.4. Vici Valves and Fittings Connections with Stainless Steel Capillaries

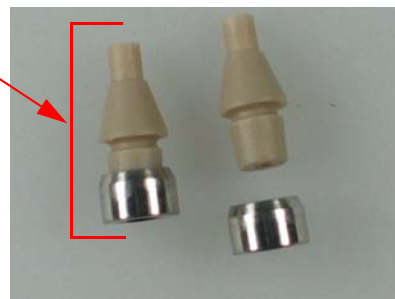


Nuts  
P/N 86014

Nuts (connected in center)  
P/N 86606

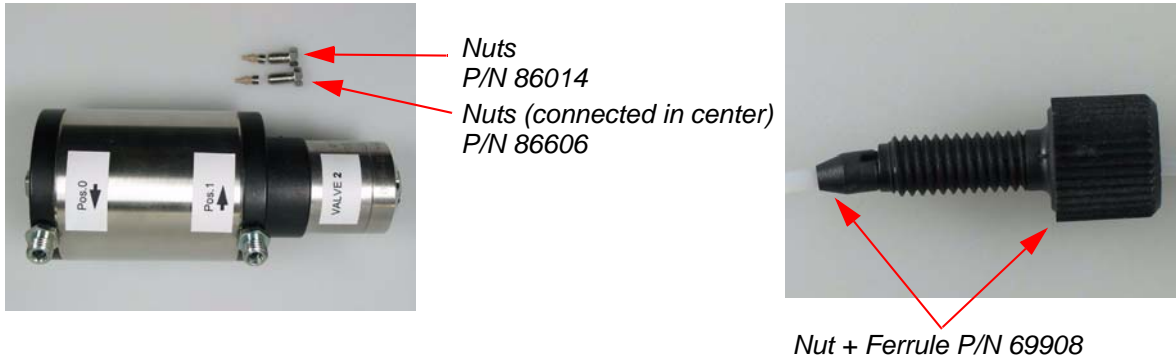
Vici Valve Heads

Ferrule  
P/N 86526



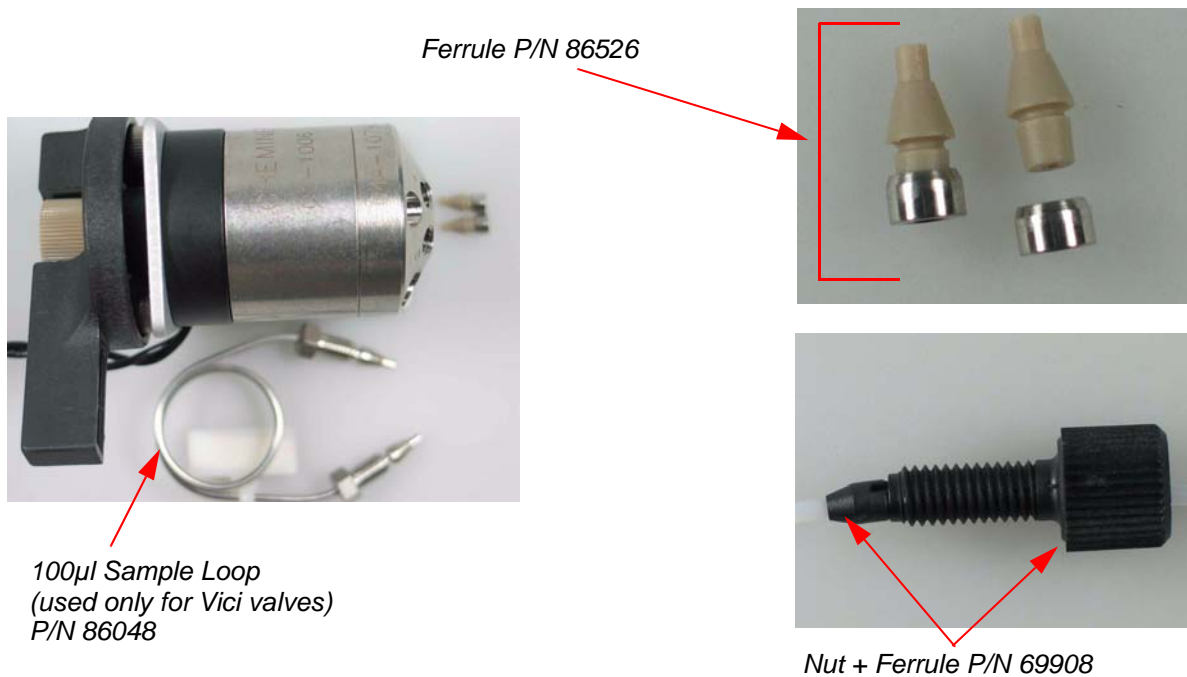
Electrical Actuator

Figure 6.5. Vici Valves and Fittings with PTFE Tubing Connections



The Vici injection valve uses the same fittings and ferrules as the other Vici valves, but requires a special 100µl sample loop (P/N 86048) shown in the figure below.

Figure 6.6. Vici Injection Valve and Fittings Connected with 1/32" Steel Capillary.



On the front plate are 4 capillary passages (see **Figure 6.7.**).

- Two of them are PTFE waste capillaries with 1/16" OD, 0.5mm ID;
- One is the output coming from the UV Cell 1 (stainless steel 1/16" OD, 0.005" ID);
- One is for the input (stainless steel 1/32" OD, 0.254mm ID).

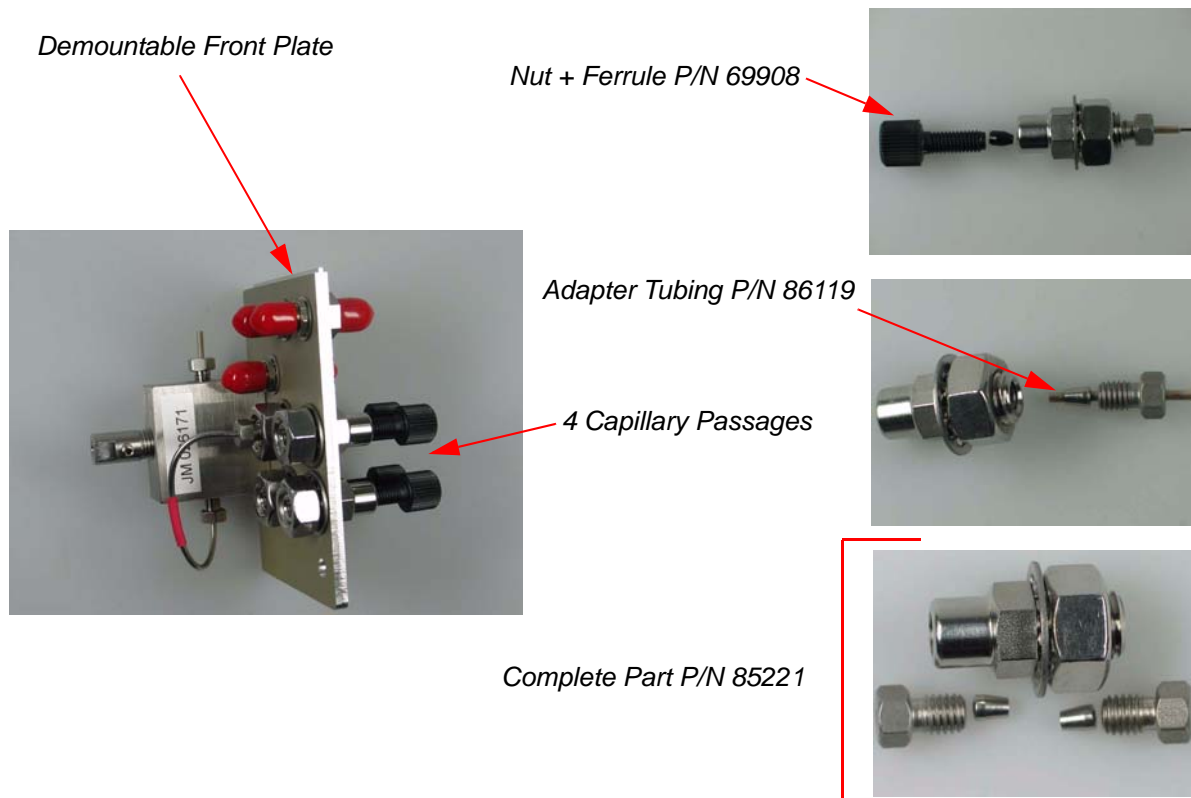
An adapter tubing (P/N 86119) is necessary for all 1/32" capillaries which connect to stainless steel ferrules and nuts.



All 1/32" capillary connections with tube adapters and stainless steel nuts/ferrules must be tightened securely, i.e. with a wrench.

All 1/32" capillary connections with combined peek/metal ferrules (Vici valves) should **only be carefully hand-tightened** and under no circumstance to the end stop.

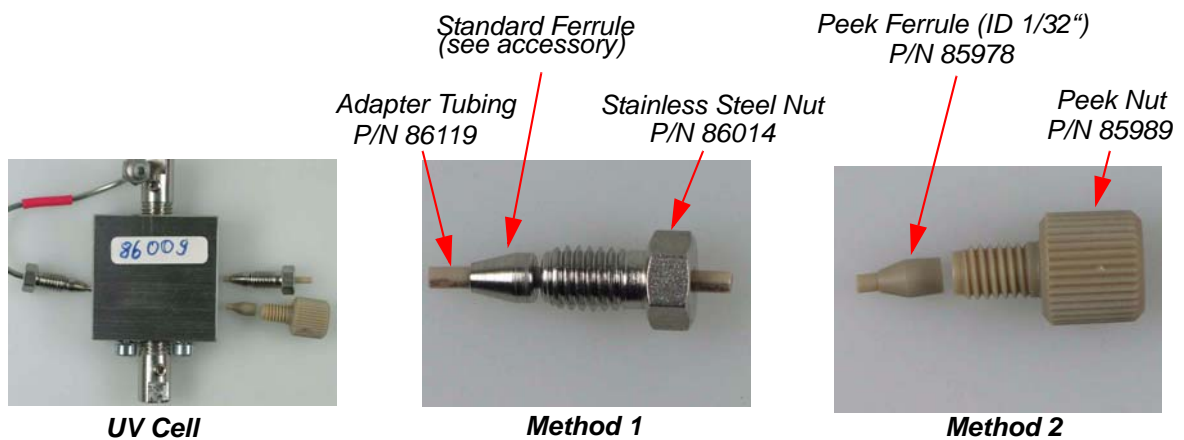
Figure 6.7. Fittings and Ferrules on Front Plate Connector



In the BMSO there are 2 methods (Fitting/Ferrule) used to connect the 1/32" stainless steel capillaries to the UV-cell as shown in **Figure 6.8**.

- The first method uses a stainless steel nut and ferrule to connect the UV Cell 1 behind the front plate. This combination requires an adapter tubing with an outer diameter (OD) of 1/16" and an inner diameter (ID) of 0.004" so that the 1/32" capillary clamps securely.
- The other method uses a peek nut and peek ferrule (ID 1/32") for the capillary connection.

Figure 6.8. Fittings and Ferrules on UV cell s



## Replacing the Air Actuator Valve

The air actuator valve **should only be replaced by trained service personnel**.

Before dismantling the valve actuator unit, move the valve to position 0. Position 0 is the left limit stop as viewed from the valve (see **Figure 6.9**).

Figure 6.9. Valve Null Position



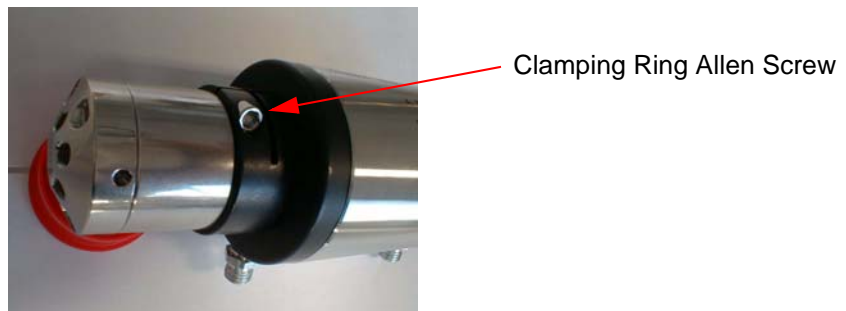


## Service Information

The following steps are necessary for replacing an air actuator valve:

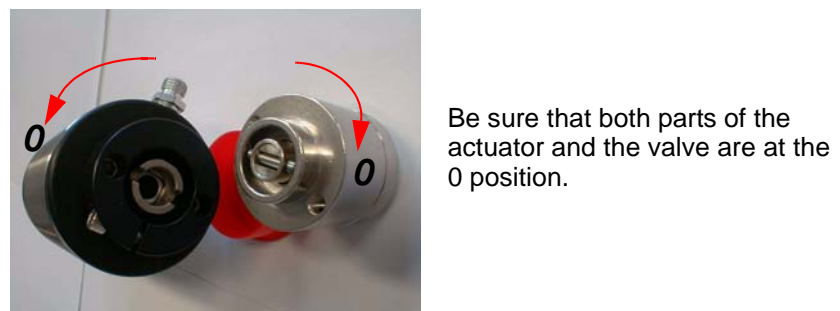
1. Disconnect the line cord, ETH-connector, pneumatic tube, fiber optics, and all the capillaries from the BMSO.
2. Install the transportation lock in front of the drawer.
3. Remove all rack holder screws.
4. Move the BMSO out of the rack.
5. Remove the BMSO cover.
6. Remove all the capillaries from the valve (valve No. 2).
7. Remove all the pneumatic tubes.
8. Remove valve 2 from the EPP foam.
9. Loosen the clamping ring allen screw (figure 6.10)

*Figure 6.10. Location of the Clamping Ring Allen Screw*



10. Remove the valve. Before assembling the new valve, move it to the 0 position as shown in figure 6.11. Be sure that both parts of the actuator and the valves are in the 0 position.

*Figure 6.11. Removing the Valve*



Be sure that both parts of the actuator and the valve are at the 0 position.



11. Assemble the valve and actuator as instructed in **Figure 6.12**.

Figure 6.12. Eliminating the Clearance



Assemble the valve and actuator.

**Before tightening the Allen screw, the clearance must be eliminated as follows:**

- Hold the actuator tightly and turn the valve to the left until no more clearance is available.
- Tighten the allen screw in this position.

**This step is critical for correct functionality!**

### Replacing the Electric Actuator (Column Selection) Valve

6.6

The electric actuator valve **should only be changed by trained service personnel**.

The following steps are necessary for replacing an electric actuator valve:

- Disconnect the line cord, ETH-connector, pneumatic tube, fiber optics, and all the capillaries from the BMSO.
- Install the transportation lock in front of the drawer.
- Remove all rack holder screws.
- Move the BMSO out of the rack.
- Remove the BMSO cover.
- Remove all the capillaries from the valves (valves No. 3 and 4).
- Remove the column selection valve from the EPP foam and disconnect the connector.
- Loosen the clamping ring Allen screw and remove the valve (don't lose the adapter ring).
- Put in the new valve (valve fits only in one position), then tighten the Allen screw.
- Replace the valve in the correct position inside the EPP foam.
- Replace all the parts/connections in reverse order as described above.

Table 6.1. Cable Configuration in the BMSO

Part Description	Part Number
BMSO Harness AC	HZ10260
BMSO Harness DC	HZ10266
BMSO Harness Signals	HZ10265
BMSO Harness Pneumatic	HZ10271
BMSO Harness Power Supply Remote ON/OFF	HZ10272

Table 6.2. List of Major Parts in the BMSO

Part Description	Part Number
BMSO Control Board	H10064
BPSU36-2 100MBIT Ethernet Board	H10059
Universal BBIS Board	H5783
Ventilator 24V	19991
Pneumatic Valve Block	85301
Power Supply	85348
Micro Door Switch	HZ12501
Injection Valve (No.1)	Rheodyne:68969 Vici: 85991
Sample Loop 100ul (for Rheodyne Valve)	86049
Sample Loop 100ul (for Vici Valve)	86048
Valve 6Port 3L 2Position (No.2)	85363
Valve Column Selector (No.3, No.4)	85195
BMSO Plexiglas Window	HZ09010
UV cell	86009
Fiber Optics (400mm)	84266 Variant 4
Fiber Optics (1180mm)	84266 Variant 12

**Capillary Wiring****6.8**

The tube binders that are in place in the heating chamber should be replaced with the relevant columns that are needed for the specific application or experiment that will be carried out.

The connection nomenclature is as follows:

- The column No. 1 is the next behind the drawer frontplate.
- The second column that follows is the second and so on.

The abbreviated labeling used on the capillary wiring is listed in table 6.3.

*Table 6.3. Labeling Used on the Capillary Wiring*

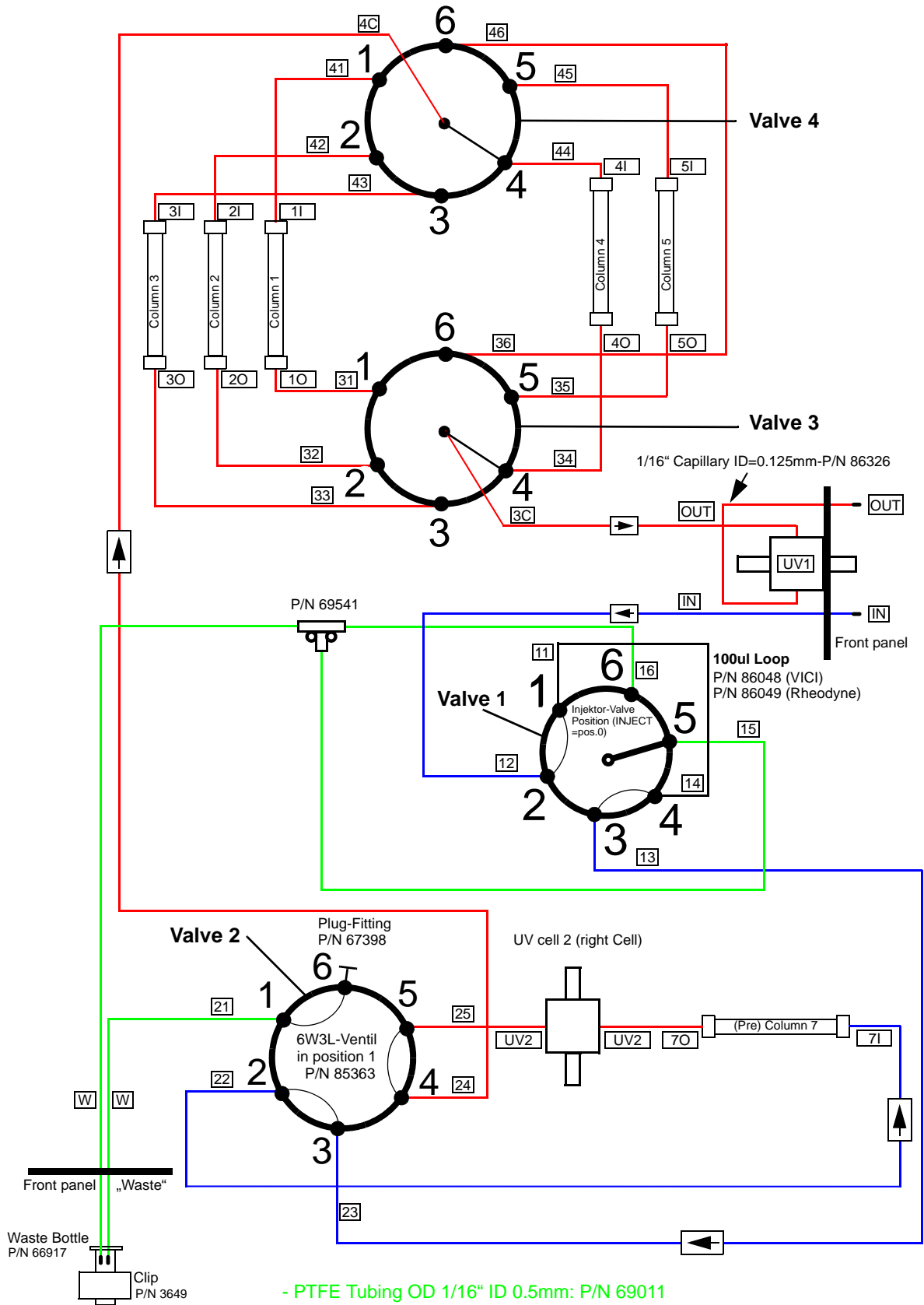
Abbreviation	Meaning
<b>W</b>	<b>W</b> aste
<b>UV1</b>	<b>UV</b> Cell 1
<b>UV2</b>	<b>UV</b> Cell 2
<b>7I</b>	Column No. 7 (pre-column) <b>I</b> N
<b>7O</b>	Column No. 7 (pre-column) <b>O</b> UT
<b>1I</b>	Column No. 1 <b>I</b> N
<b>1O</b>	Column No. 1 <b>O</b> UT
<b>3C</b>	Valve No. 3 <b>C</b> enter
<b>4C</b>	Valve No. 4 <b>C</b> enter
<b>11</b>	Valve No. 1 Port No. 1
<b>12</b>	Valve No. 1 Port No. 2

**BMSO Capillary Internal Wiring****6.8.1**

The stainless steel capillary requires special conditioning to achieve an absolute flush surface after cutting (self cutting is not possible). All metal capillaries used in the BMSO have a fixed length and each length has its own part number. For a list of replacement capillaries refer to [Table 6.4.](#)

# Service Information

Figure 6.13. Capillary Wiring Schematic



- PTFE Tubing OD 1/16" ID 0.5mm: P/N 69011
- Stainless Steel Tubing OD 1/32" ID 0.008" (0.2)mm
- Stainless Steel Tubing OD 1/32" ID 0.01" (0.254)mm

Table 6.4. Table of Internal Capillaries

From	Until	Capillary P/N	Capillary Length
16 (Valve 1 Port 6)	T-PIECE	PTFE P/N 69011	390mm
15 (Valve 1 Port 5)	T-PIECE MIDDLE	PTFE P/N 69011	390mm
Front panel connector: "Waste"	T-PIECE	PTFE P/N 69011	790mm
Front panel connector: "Waste"	21 (Valve 2 Port 1)	PTFE P/N 69011	900mm
26 Close with plug (P/N 67398)			
11 (Valve 1 Port 1)	14 (Valve 1 Port 4)	Sample Loop 100µL P/N 86048 (VICI) P/N 86049 (Rheodyne)	
23 (Valve 2 Port 3)	13 (Valve 1 Port 3)	Metal P/N 86506	410mm
12 (Valve 1 Port 2)	Front panel connector: "IN"	Metal P/N 86500	1180mm
36 (Valve 3 Port 6)	46 (Valve 4 Port 6)	Metal P/N 86504	300mm
UV cell 1(Front Panel)	3C (Valve 3 Center)	Metal P/N 86507	900mm
24 (Valve 2 Port 4)	4C (Valve 4 Center)	Metal P/N 86503	350mm
31 (Valve 3 Port 1)	C1O(Column1Out)	Metal P/N 86510	480mm
32 (Valve 3 Port 2)	C2O(Column2Out)	Metal P/N 86511	460mm
33 (Valve 3 Port 3)	C3O(Column3Out)	Metal P/N 86512	440mm
34 (Valve 3 Port 4)	C4O(Column4Out)	Metal P/N 86501	420mm
35 (Valve 3 Port 5)	C5O(Column5Out)	Metal P/N 86502	400mm
41 (Valve 4 Port 1)	C1I (Column1 In)	Metal P/N 86510	480mm
42 (Valve 4 Port 2)	C2I (Column 2 In)	Metal P/N 86511	460mm
43 (Valve 4 Port 3)	C3I (Column 3 IN)	Metal P/N 86512	440mm
44 (Valve 4 Port 4)	C4I (Column 4 IN)	Metal P/N 86501	420mm
45 (Valve 4 Port 5)	C5I (Column 5 IN)	Metal P/N 86502	400mm
22 (Valve 2 Port 2)	C7I (Column 7 IN)	Metal P/N 86505	590mm
UV cell 2	25 (Valve 2 Port 5)	Metal P/N 86509	250mm
UV cell 2	C7O(Column7OUT)	Metal P/N 86508	580mm
UV cell 1 (Front Panel)	Front-panel connector: "OUT"	Metal P/N 86326 OD1/16, ID=0.125	100mm

In the standalone version, when no BPSU36-2 is present, an external valve is placed under the BMSO in the rack which is needed for stop/flow applications.

Refer to **Figure 6.14.** for the capillary connections.

Figure 6.14. Capillary Wiring External Valve1

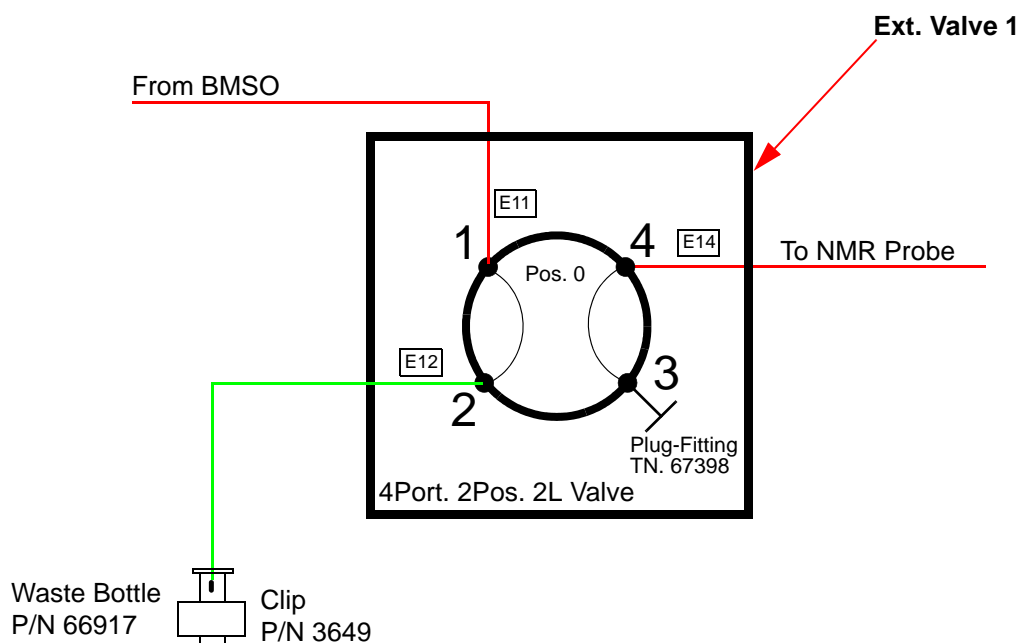


Table 6.5. Table of External Capillaries

From	To	Capillary P/N	Capillary Length
Front panel connector: "OUT".	E11(Ext. Valve1 Port1)	Metal P/N 86497	200mm OD=1/16" ID=0.18mm
E12 (Ext. Valve1 Port 2)	Waste Bottle	PTFE P/N 69011	1000mm
E14 (Ext. Valve1 Port 4)	To NMR Probe		
E13 Close with Plug (P/N 67398)			

# Serial Interface Control

# 7

## BMSO RS232 Connector

## 7.1

The RS232 at the rear of the BMSO unit uses a 9 pin Mini-D male connector and has the same pin layout as used in an IBM compatible PC:

This interface is used to set up the Ethernet parameters (after RESET), or as a DEBUG interface.

If the BMSO is used as standalone unit, the BMSO controls the external valve over this interface.



It is not possible to control the BMSO via the RS232 Interface.

Table 7.1. RS232 Interface Pin Connections

Pin	Description	Pin	Description
1	Not Used	6	Not Used
2	RxD	7	RTS
3	TxD	8	Not Used
4	Not Used	9	Not Used
5	GND	10	

Baud Rate: 9600

Data Bits: 8

Stop Bits: 1

Parity: None

Flow Control: RTS (or none). Software flow control is not supported.

The BMSO is designed for exclusive control over the Ethernet.

Normally, the HyStar software program (version 3.0 or later) is used to control the BMSO, BPSU36-2 and BNMI, DAD, etc.

It is also possible to run each unit as a stand-alone unit.



# Cable Wiring

# 8

## Boards in the BMSO

## 8.1

There are three boards installed inside the BMSO:

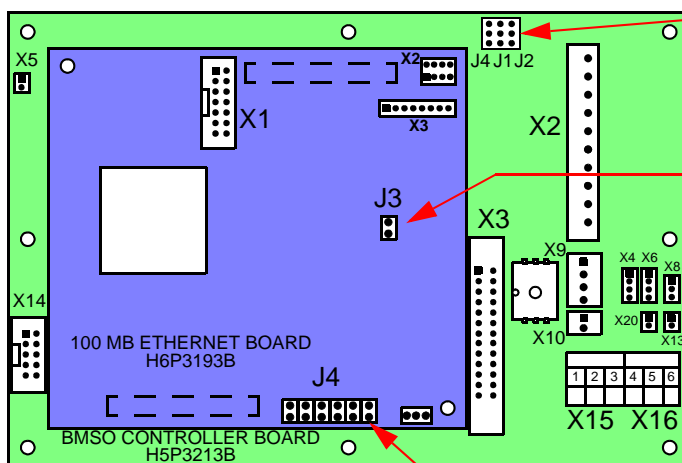
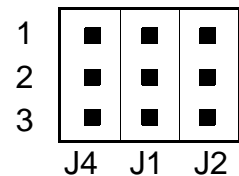
1. **The BMSO Controller board** (see the green board): On this board are the serial A/D converter, RS232 Interface, analog signal processing (sensor signals), actuating of the heating foil and the pilot valves and all connectors.
2. **The 100MB Ethernet board** (see the blue board): On this board are the processing unit and the ethernet interface.
3. **The universal BBIS board** (see the brown board): This board contains memory used to store BMSO unit data (P/N, production date, EC level, etc.).

Figure 8.1. Jumper Settings on the BMSO Control Board only **H5P3213B**

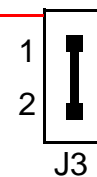
Jumper J1 is not used! All pins are connected on solder side.

Jumper J2 is not used! All pins are connected on solder side.

Jumper J4 is not used!



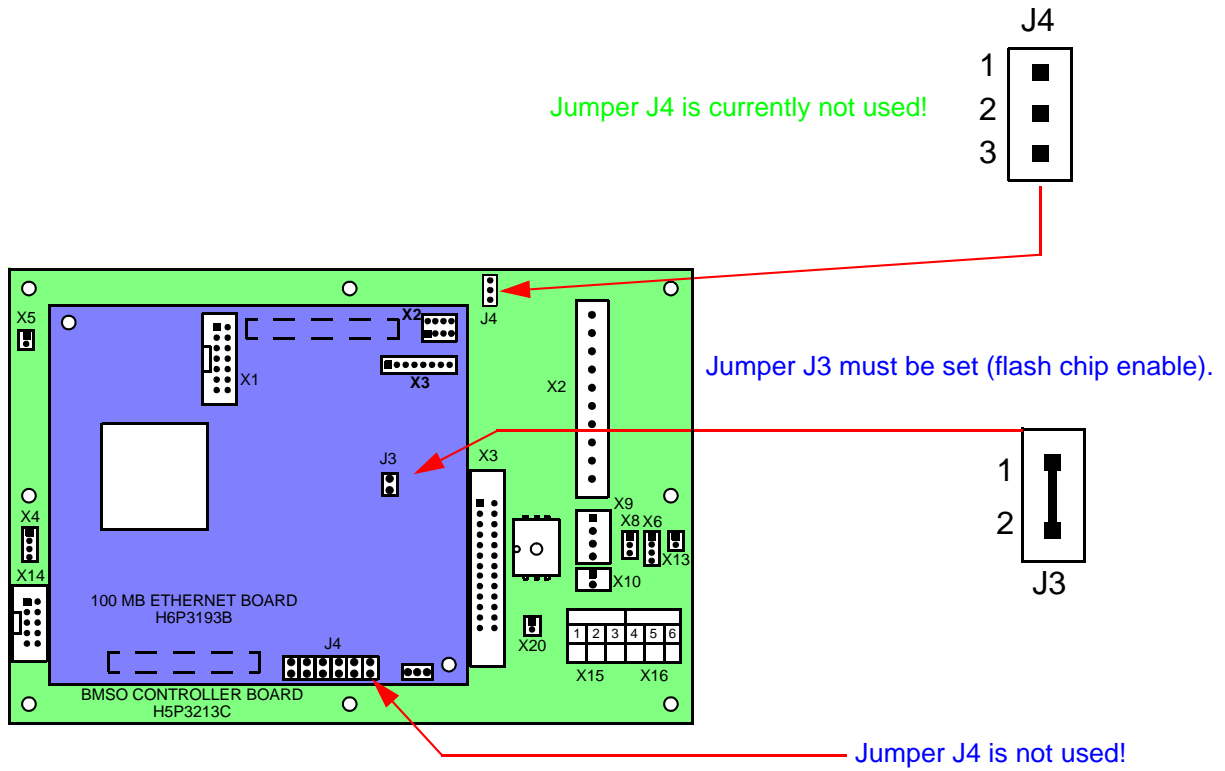
Jumper J3 must be set (flash chip enable).



Jumper J4 is not used!

# Cable Wiring

Figure 8.2. Jumper Settings on the BMSO Control Board only **H5P3213C**



## Fan Connector X5

8.1.1

Figure 8.3. The Fan Connector X5

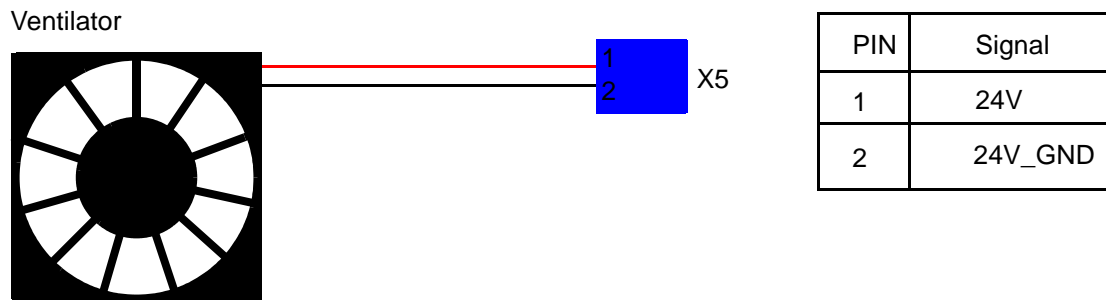


Figure 8.4. The BIS Connector X14

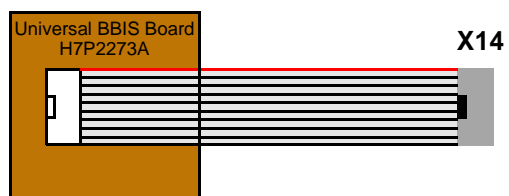


Figure 8.5. The BMSO Control Board Connections

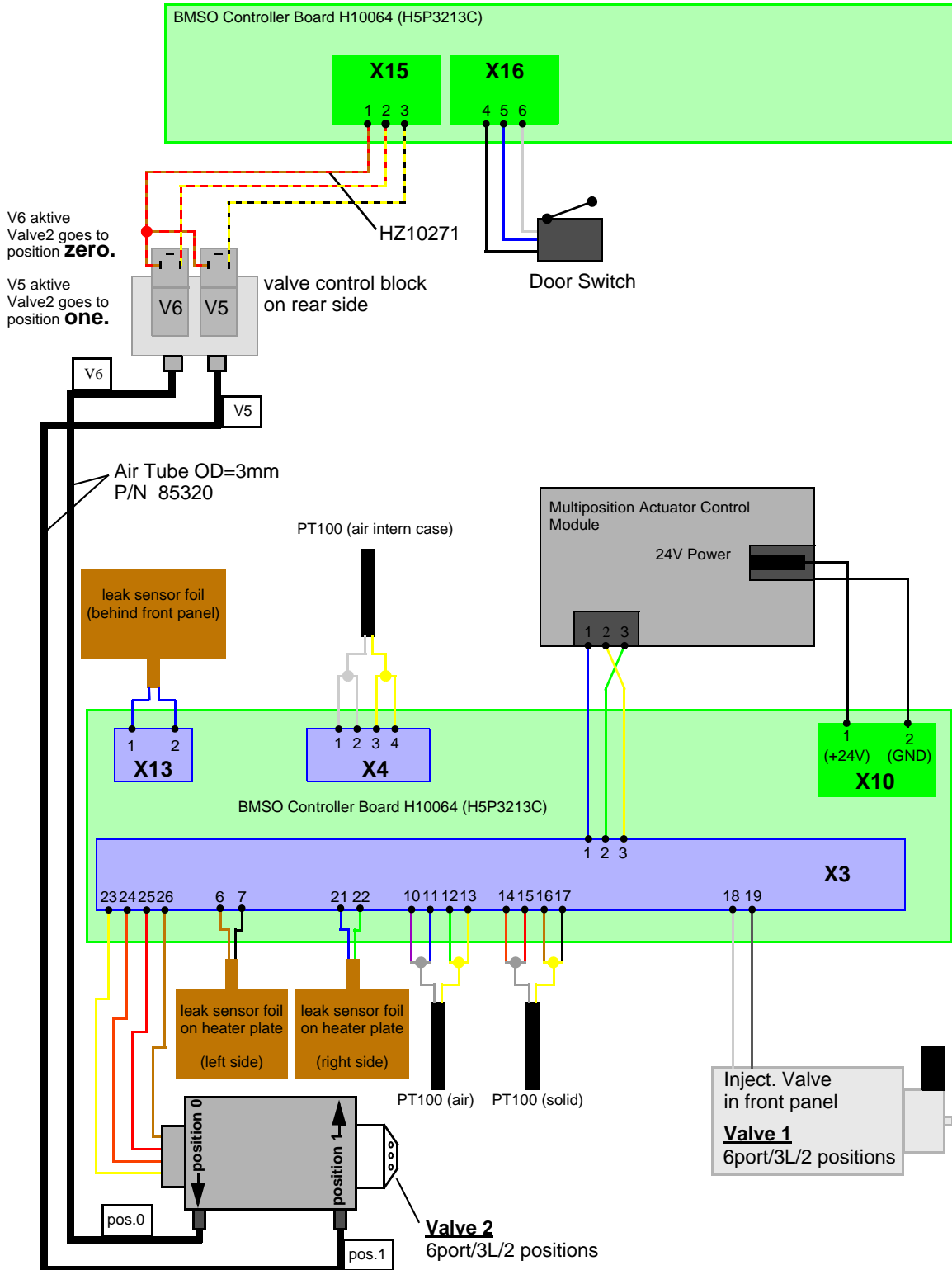
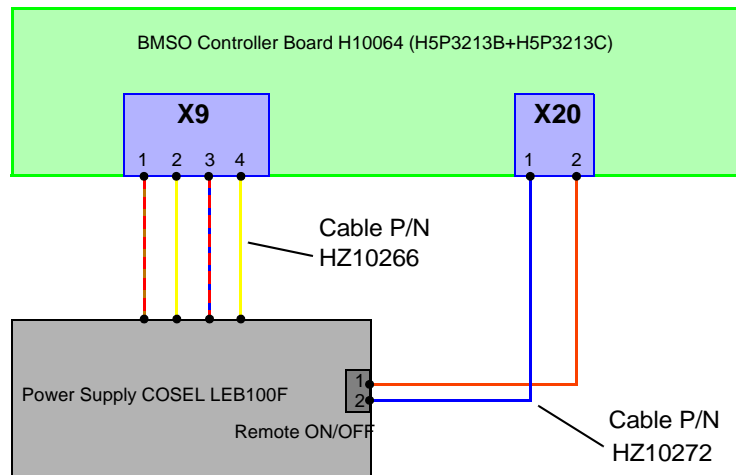


Figure 8.6. The Power Connector X9 and Remote Connector X20



# BMSO SENSOR WIRING

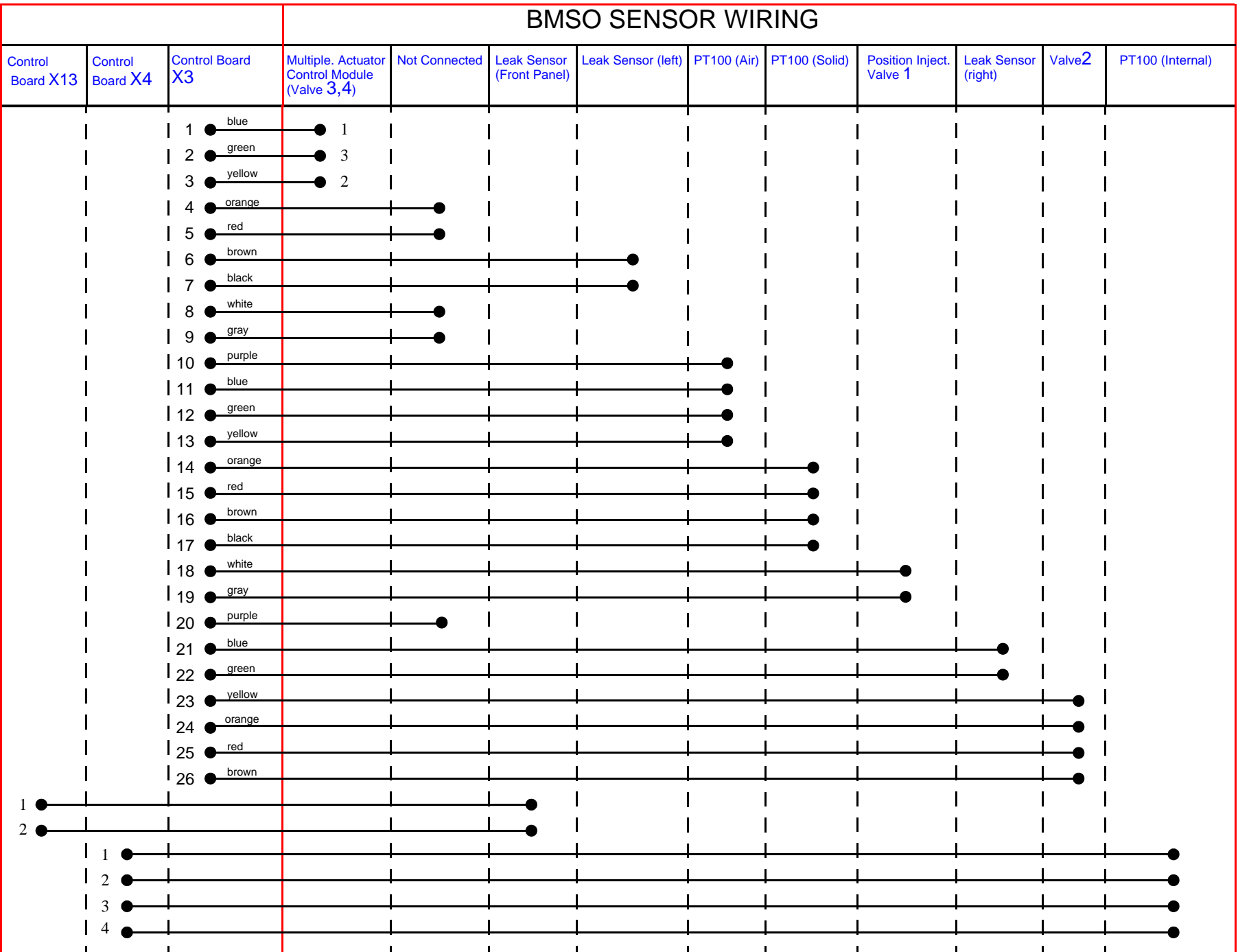


Figure 8.7. BMSO SENSOR WIRING

## **Leakage Detected**

**9.1**

Most leaks are caused by blockage inside the tubing and valves, or through defective ferrules. When HyStar detects a leakage, you must look for and fix the problem. The leak sensor must then be clean using a dry cloth. The warning message will no longer displayed when the leak sensor has been properly cleaned.

All capillaries are pressurized up to 300 bar. Under this high pressure it is possible that the capillary may jump out of the ferrule. To help prevent this, it is better to use a new ferrule when making a new connection.

Another reason that a leak may be detected is when a capillary touches a leak sensor and causes a short circuit. In this case you will need to reposition the capillary or sensor.

## **Defective Capillary**

**9.2**

If a capillary buckles or breaks you must replace it. Each capillary is machine cut, the ends polished, and the inside/outside edges deburred and passivated by the capillary manufacturer. Therefore, it is not possible to cut the metal capillary yourself, rather you must order the appropriate capillary. To make this easier each capillary length has been assigned an individual part number see "**Capillary Wiring Schematic**" on page 58 and **Table 6.4.**

## **No Heating is Possible**

**9.3**

If the heater does not function, check if the drawer is closed completely. When the door properly closed, the door switch detector should indicate that it is closed.

## **Not Possible to Open the Drawer**

**9.4**

If you have installed columns that are too long inside the heating chamber or the capillaries and lines are in the incorrect position, is possible that these may block the heating chamber cover and prevent you from opening the drawer.

If this happens:

- Switch off the BMSO
- **Disconnect the mains power cable**
- Pull out the BMSO about 10cm

- Loosen the 2 screws at the BMSO's cover
- Lift the cover 2cm
- Push the heating chamber cover downwards and open the drawer at the same time.
- Check to see what was blocking the cover and either exchange the capillaries or reposition the lines.
- Make sure that the heating chamber cover closes correctly before closing the drawer again.
- Reassemble all the unit in the opposite order as described above.
- Reconnect the mains power cable and switch on the BMSO.

### **Warnings and Error Messages**

### **9.5**

If the temperature inside the BMSO rises to 40°C (air temperature near power supply and boards), the BMSO send a warning to HyStar.

If the temperature reaches the 48°C limit, then the BMSO sends an alarm to HyStar and switches off the heater.

The BMSO will also send an alarm to HyStar and switch off the heater if a temperature sensor is not connected or an interrupt occurs.

For an example of the message table **Figure 10.9.**



# Embedded Web Server

# 10

## The BMSO Homepage

10.1

---

The BMSO is controlled via an Ethernet interface. The unit responds either to commands from HyStar (version 3.0 or later), whereas the status is displayed on the homepage, or from selections made from the service pages. The homepage is an XML page containing status information, which can be accessed using the URL: ***IP address/status.xml***.

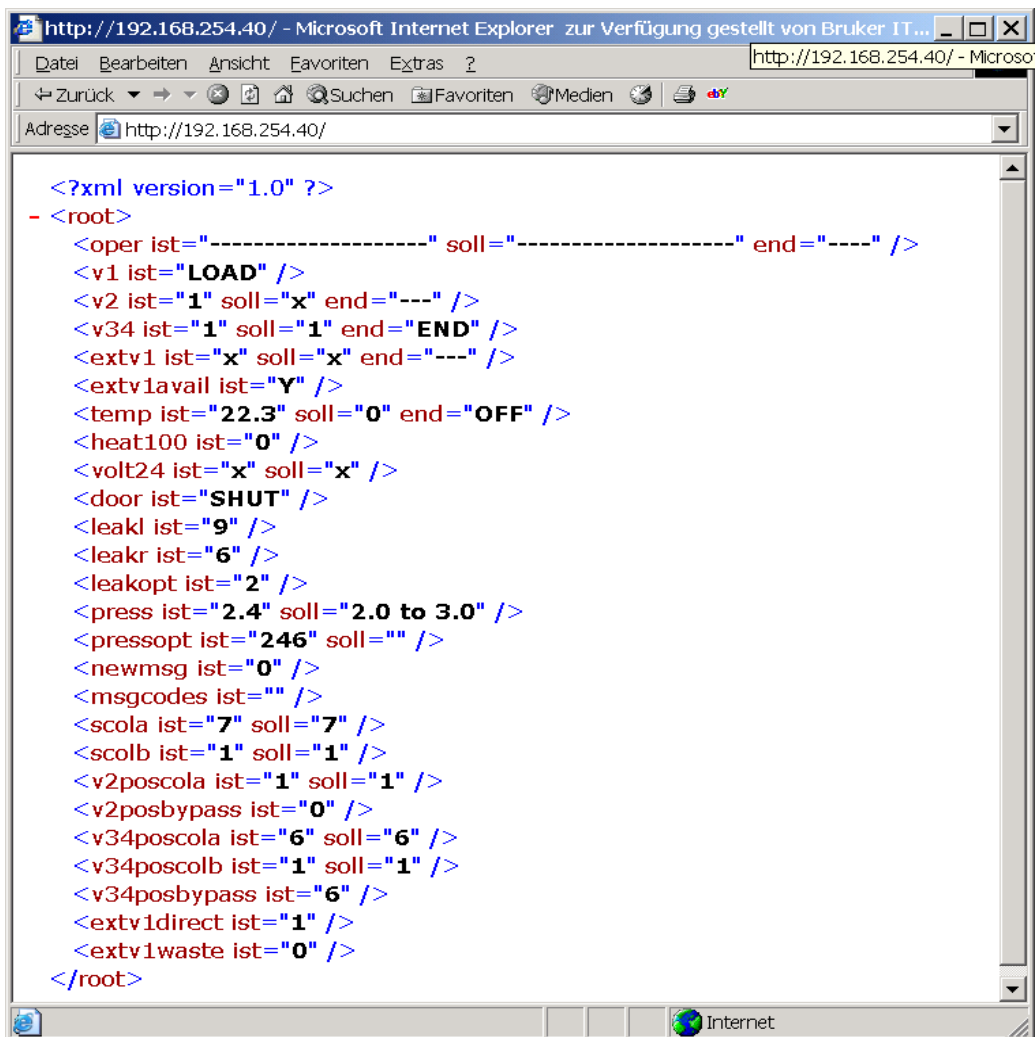


---

All hyperlinks in this document assume that the system is configured with the default IP address 192.168.254.40

---

Figure 10.1. Embedded Web Server Home (Status) Page



The factory set IP address normally used in an LC-NMR system is: 192.168.254.40

Table 10.1. Status Used on the BMSO Homepage

Status	Meaning	Example
<b>ist</b>	Present status of the associated component.	<pre>&lt;v2 ist="1" soll="x" end="---" /&gt;</pre> <p>The value of v2 is "1", should be "x", and the function/operation has not yet ended (when the function is done end="END" will be displayed). If an error occurs "ERR" will be displayed.</p>
<b>soll</b>	The required or target value of the component.	
<b>end</b>	The value indicates whether the last function for this component has been completed successfully.	
<b>err</b>	An error has occurred and the operation has been aborted.	
<b>run</b>	Indicates that the operation is still in process.	

The Homepage displays the status for the following components:

**oper** Shows the status of the rotary valve.

INIT  
 DIRECTFLOW  
 DIRECTSTOP  
 PRESEPWASTE  
 PRESEPTRAP  
 WASHPROBE  
 WASHTRAP  
 SAMPLELOOP  
 TRANSFERLOOP  
 WASHLOOP

**v1** Shows the position of Valve 1 (Injection Valve).

LOAD load position  
 INJECT inject position  
 X position undefined

**v2** Shows the position of Valve 2

0 actual position 0  
 1 actual position 1

**v34** Shows the position of Valve 34 (column selection valve).

- 1 actual position 1
- 2 actual position 2
- 3 actual position 3
- 4 actual position 4
- 5 actual position 5
- 6 actual position 6

**extv1** Shows the position of external Valve 1 (additional valve).

- 0 actual position 0
- 1 actual position 1

**extv1avail** Shows whether the external Valve 1 is selected.

- Y external Valve1 is selected
- N external Valve1 is not selected

**temp** Shows the temperature in Celsius for the heating chamber.

**heat100** Shows the condition of the max. heating option.

- 0 maximum heating option is disabled
- 1 maximum heating option is enabled

**volt24** Shows whether the 24V is switched ON or OFF.

- 0 24V is switched OFF
- 1 24V is switched ON

**door** Shows whether the drawer is open or closed.

shut the drawer is shut  
open the drawer is open

**leakl** Shows the status of the leak sensor (left side in heater chamber).

(0..255)

**leakr** Shows the status of the leak sensor (right side in heater chamber).

(0..255)

**leakopt** Shows the status of the leak sensor (behind the front plate).

(0..255)

**press** Shows the operating pressure in (bar).

(0..8,6)

**pressopt** Shows the pressure of an option (if connected on X6).

(0..255)

**newmsg** Shows if messages are present.

0 no messages present  
1 messages are present

**msgcodes** Shows a list of the last 20 message codes.

**scola** Shows the value of the variable.

(X,1..7)

**scolb** Shows the value of the variable.

(X,1..6)

**v2poscola** Shows the value of the variable

0 bypass precolumn  
1 no bypass precolumn

**v2posbypass** Shows the value of the variable.

0

**v34poscola** Shows the value of the variable.

(1..6) 1..5 = column 1..5, 6=bypass column

**v34poscolb** Shows the value of the variable.

(1..5) 1..5 = column 1..5

**v34posbypass** Shows the value of the variable.

6

**extv1direct** Shows the position of external Valve 1.

1 external valve 1 on position 1 (to NMR)

**extv1waste** Shows the position of external Valve 1.

0 external valve 1 on position 0 (to waste)

HyStar normally polls this page about twice per second. The unit responds to any commands sent by HyStar by sending information to the homepage. In this case the 'end' status for the command operation sent is 'OK', which indicates that a command has been received.

## The BMSO Service Pages

10.2

The BMSO service pages provide information for testing, monitoring and servicing. The URL for the BMSO Service Web is ***ip-address/ews.html***.

These pages can be viewed on a PC, Laptop, Macintosh etc. using a standard browser (Internet Explorer, Netscape etc.).

### The Main Page: 'ews.html'

10.2.1

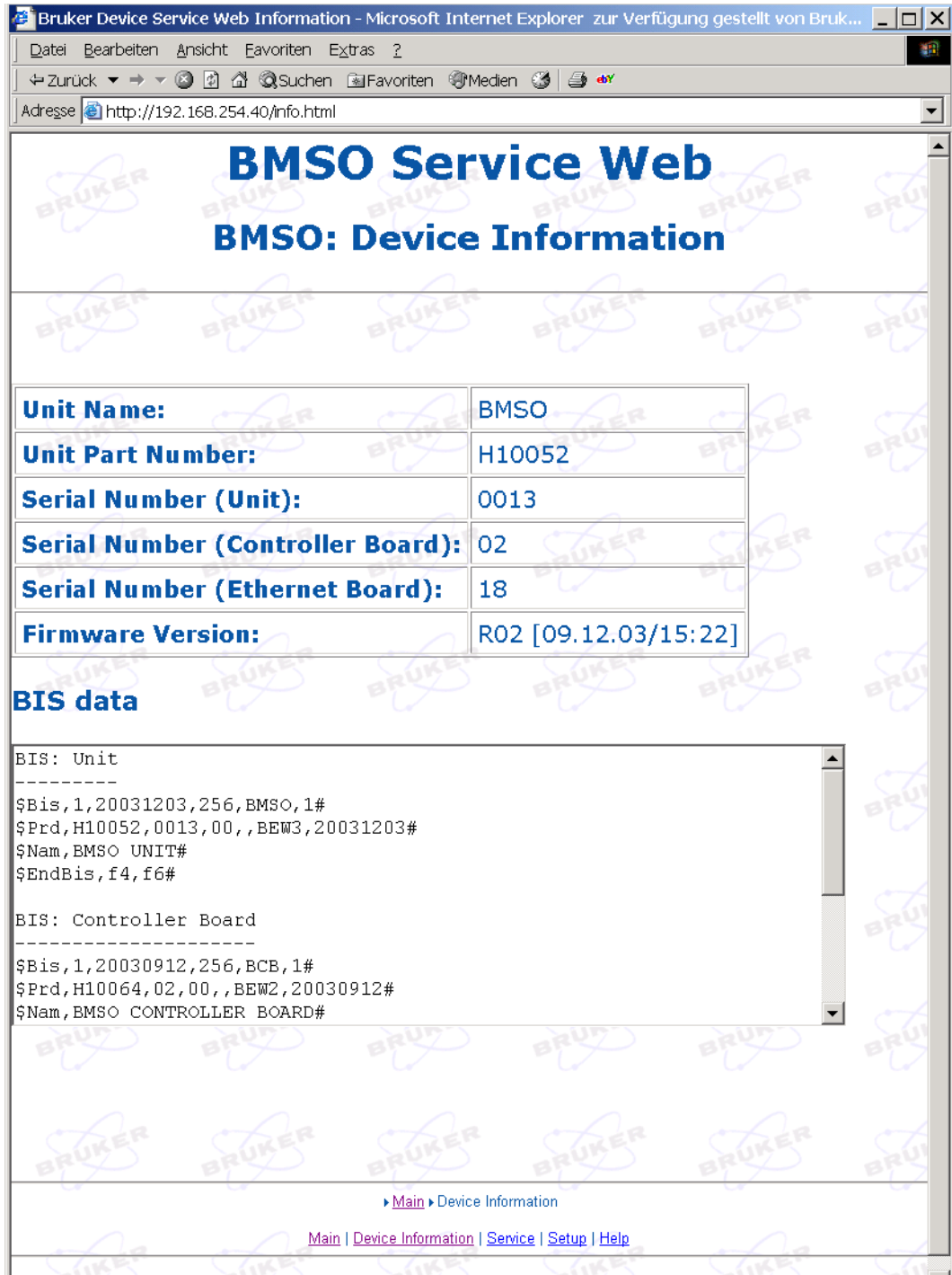
Figure 10.2. Embedded Web Server (EWS) Service Page



Links from this page take you to the other service related pages. To return to the main service page from any of the following service pages, click on the link [Main](#).

To open the **Device Information** page click on the link [Device Information](#). The following page will appear:

Figure 10.3. Device Information Page



This page displays information about the various firmware levels in use on the Ethernet and control boards.



To open the **Service** page click on the link [Service](#). The following page will appear:

Figure 10.4. Service Page



This page contains a number of links to pages in which the individual functions of the BMSO can be initiated and the status checked.

To open the **Operation Modes** page click on the link Operation Modes. The following page will appear:

Figure 10.5. The Operation Modes Page

**BMSO Service Web**  
**BMSO: Operation Modes**

**Operation Modes**

	Operation Status	Status	Target	Action
Operation Mode	Init	END	Init	Do it!

**Valve Configuration**

**Commands to set the variables**

Command	Possible Values	Present Value	New Value	Action
SetCol-A	1..7 [7]	7	7	Do it!
SetCol-B	1..6 [1]	1	1	Do it!
-	-	-	Refresh	-

[Main](#) | [Service](#) | [Operation Modes](#)  
[Main](#) | [Device Information](#) | [Service](#) | [Setup](#) | [Help](#)

The target or required values for the associated operation can be selected in the Target column. Clicking on the button in the Action column sends the command to the BMSO. The BMSO responds by resending the above page, which indicates that the command was received 'OK'. To monitor the status of an operation click on the Refresh link. **Do not use the browser page refresh button, as this will only reload the old values!**

The Valve Position and Variable Setting Page: 'valves.html'

10.2.5

To open the **Valve Positions and Variables** page click on the link Valve Positions and Variables. The following page will appear:

Figure 10.6. The Valves Positions and Variables Settings Page

The screenshot shows a web browser window titled 'Bruker Device Service Web - Service - Valves - Microsoft Internet Explorer'. The address bar shows 'http://192.168.254.40/valves.html'. The main content area has the heading 'BMSO Service Web' and 'BMSO: Valve Positions and Variables'. Below this, there are two sections: 'Move valves' and 'Set variables'.

**Move valves**

Valves	Operation	Status	Target	Action
Injection Valve (Valve 1) Posn	LOAD	n/a	n/a	n/a
Pre-Column Valve (Valve 2) Posn	1	END	1	Move Valve 2
Main-Column Valve (Valve 3/4) Posn	6	END	6	Move Valve 3/4
Ext. Stop-Flow Valve (Ext. V1) Posn	?	OFF	0	Move Ext. V1
-	-	-	-	Refresh

**Set variables**

Variable	Poss.Values [Def.]	Present Value	New Value	Action
V2-PosCol-A (Pre-Column Valve)	0..1 [1]	1	1	Set
V2-PosBypass (Pre-Column Valve)	0	0	-	-
V34-PosCol-A (Main-Column Valves)	1..6 [6]	6	6	Set
V34-PosCol-B (Main-Column Valves)	1..5 [1]	1	1	Set
V34-Bypass (Main-Column Valves)	6	6	-	-
Ext. V1-Waste (Ext. Stop-Flow-Valve)	0	0	-	-
Ext. V1-Direct (Ext. Stop-Flow-Valve)	1	1	-	-
-	-	-	-	Refresh

The target or required valve settings can be selected in the Target column. Clicking on the button in the Action column sends the command to the BMSO.

## Embedded Web Server

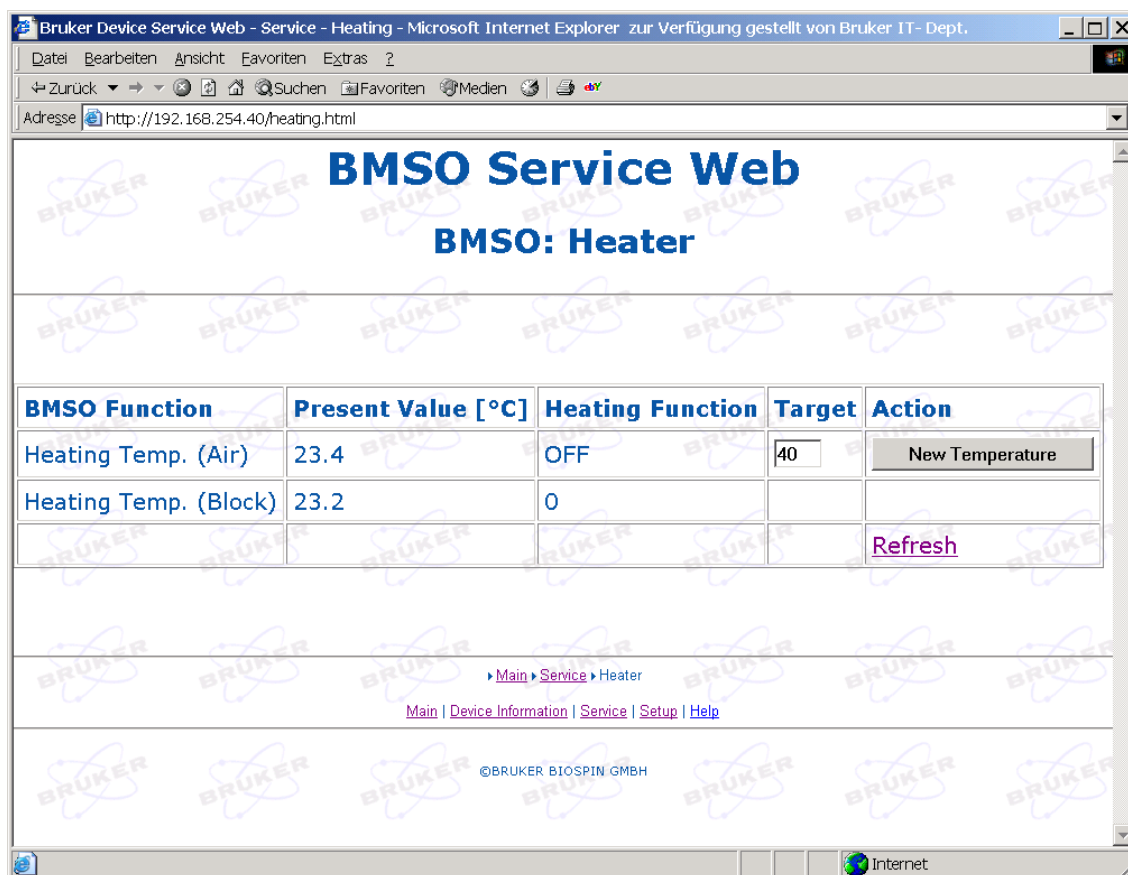
The BMSO responds by resending the above page, which indicates that the command was received 'OK'. To monitor the status of an operation click on the [Refresh](#) link. **Do not use the browser page refresh button, as this will only reload the old values!**

### The Heater Settings Page: 'heating.html'

10.2.6

To open the **Heater** settings page click on the link [Heater](#). The following page will appear:

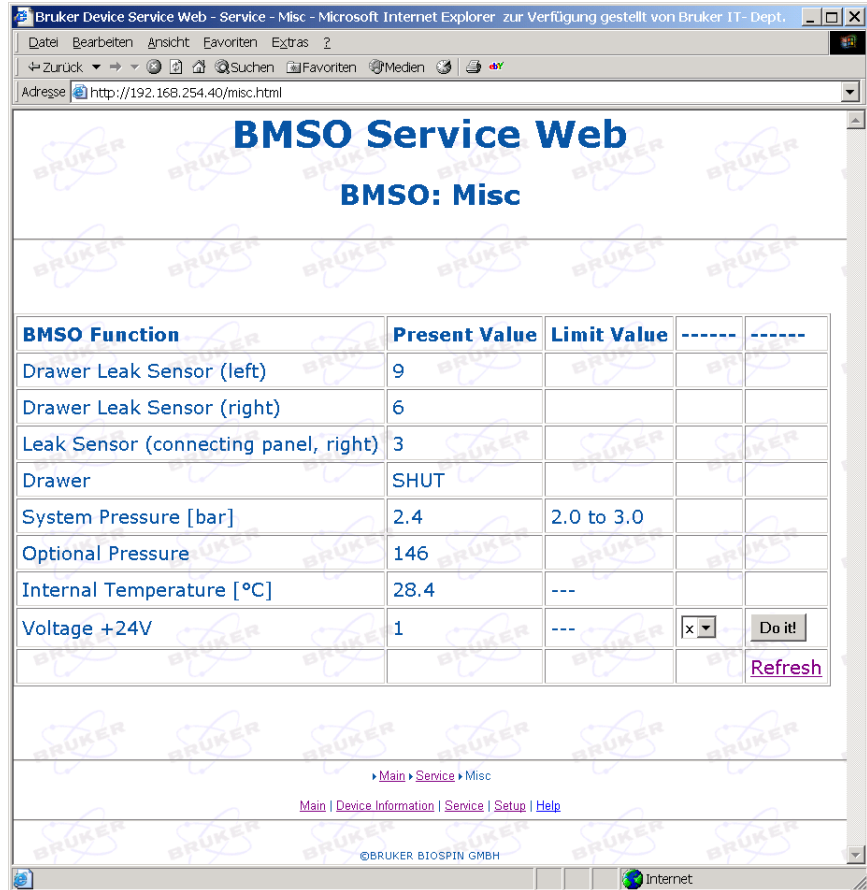
Figure 10.7. The Heater Settings Page



The target or required temperature for heating unit can be entered in the Target column. Clicking on the button in the Action column sends the command to the BMSO. The BMSO responds by resending the above page. The new target temperature is displayed in the Target column. To monitor the status of an operation click on the [Refresh](#) link. **Do not use the browser page refresh button, as this will only reload the old values!**

To open the **Misc** page click on the link [Misc](#). The following page will appear:

Figure 10.8. The Miscellaneous Settings (Misc) Page



In this window it is possible to switch the 24V power inside the power supply ON or OFF. Clicking the 'Do it' button in the Action column sends the command to the BMSO. The BMSO responds by resending the above page. The new target value is displayed in the Target column. To monitor the status of an operation click on the [Refresh](#) link. **Do not use the browser page refresh button, as this will only reload the old values!**

To open the **Messages** page click on the link Messages. The following page will appear:

Figure 10.9. The Message Page



On this page all of the current messages are displayed in the window.

The following messages are currently available (more may be added in the future).

- Alarm: Please switch off the BMSO main power.
- Alarm: Internal 24 Volt power is switched off.
- Alarm: Please check temperature sensor (AIR)!
- Alarm: Please check temperature sensor (INT)!
- Alarm: Please check temperature sensor (BLOCK)!
- Alarm: Internal temperature to high.
- Warning: Please check the fan!
- Warning: Calibration data invalid! Default data loaded.
- Warning: Input pressure out of range!

To open the **Setup** page click on the link [Setup](#). The following page will appear:

Figure 10.10. The Setup Page

**BMSO Service Web**  
**BMSO: Setup**

**Net Parameters**

IP Address	<input type="text" value="192.168.254.40"/>
Subnet Mask	<input type="text" value="255.255.255.0"/>
Standard Gateway	<input type="text" value="0.0.0.0"/>
	<input type="button" value="Save Values"/>
Net Values are valid only after next reset!	
	<input type="button" value="Press to Reset"/>

**BMSO Parameters**

(SetCol-A, SetCol-B, Ext. V1 integrated?)	<input type="button" value="Read Default BMSO Values"/>
Stop/Flow valve (Ext. V1) integrated ?	<input type="text" value="No"/>
	<input type="button" value="Save BMSO Values"/>
---	

[Main](#) > [Setup](#)  
[Main](#) | [Device Information](#) | [Service](#) | [Setup](#) | [Help](#)

Here it is possible to enter new network parameters, including IP Address, Subnet Mask and Standard Gateway. Enter the new values that are desired and click on the 'Save Values' button. The values are then saved to the EEPROM, reread from the EEPROM and then redisplayed on the above screen. The new values are first valid after a reset, whereas the unit takes approx. 10-20 seconds before you can access the service pages.



---

If you change the domain in the IP address (the first 3 numbers), you may be unable to access the new IP address after you reset the BMSO. In this case you will need to change the IP address on the host PC to match the new domain name. If you save an incorrect value do not reset the BMSO, rather first reenter and check the value again.

---



---

If you change the IP address you must make a note of it . Write the new address on a label and attach it to the ethernet port of the unit. If the ethernet address of the BMSO is not known, you can connect the unit via the RS232 port in order to set or check the IP address.

---

From the BMSO 'Setup' window you can also manually select whether the Stop/Flow valve (External Valve 1) is integrated or if a BPSU36-2 is present:

- If the External Valve 1 is present (only in the Standalone Unit), enter **Yes**.
- If the BPSU36-2 is present, enter **No**.

Press **Save BMSO Values** to save the value.



# FTP Download

# 11

## Ethernet Program Download

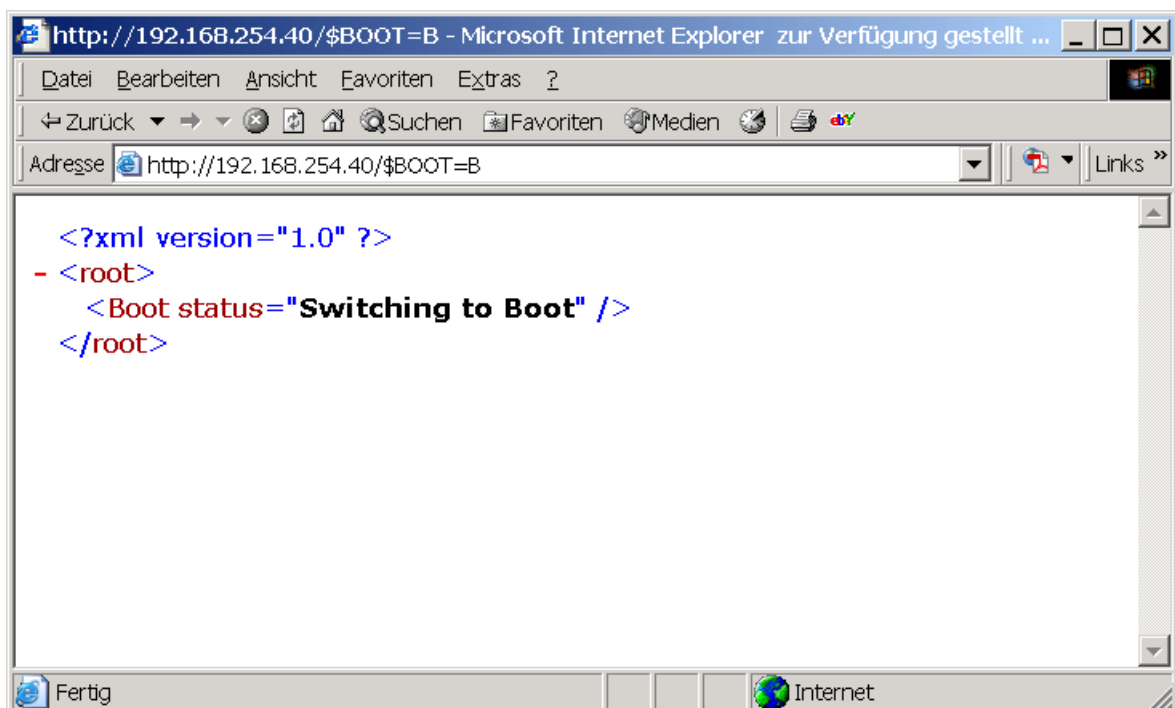
## 11.1

All BMSO (BPSU36) units are download capable. The download program is stored in a separate flash memory area from the application program.

To initiate a download the unit has to be switched into download mode. This can be done using the EWS [page 9](#).

Open a browser window (eg in Internet Explorer )and enter the address **http://192.168.254.40/\$BOOT=B**. The unit responds with the page below and displays **Switching to Boot Mode** and jumps shortly afterwards into 'Boot' Mode.

Figure 11.1. Switch to Boot Mode



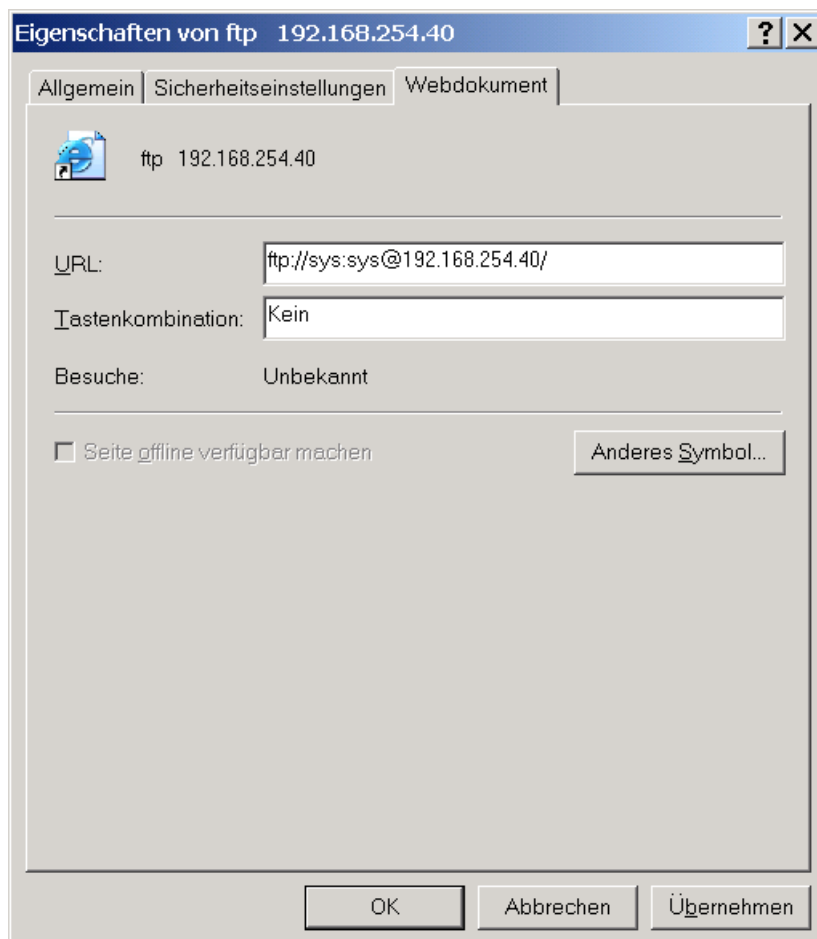
## FTP Download

Start a suitable FTP Program and make a connection to the BMSO. (e.g. with the Freeware Program FTP Commander 7.0). You can also use Internet Explorer for the FTP transfer if you have nothing better. Setup is as follows:

Server Address: 192.168.254.40  
Port 1 - 999 (don't care, default 25)

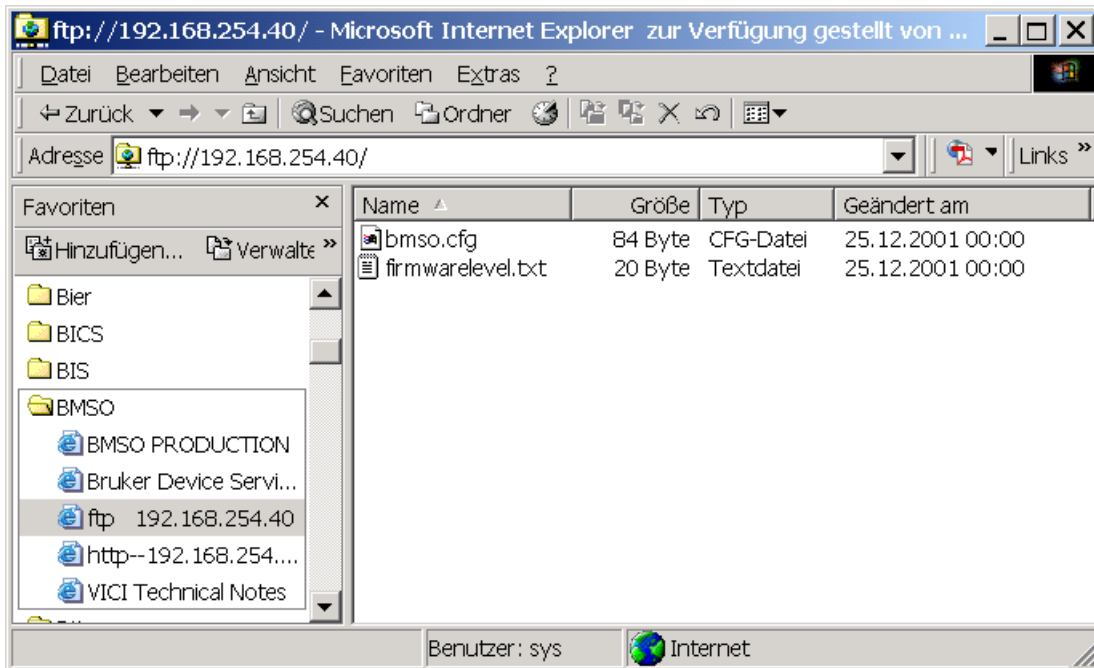
(User: **sys**, Password: **sys**)

You can save this into your Internet Explorer favorites:



Now Enter the address **ftp://192.168.254.40/** . The unit responds with the page **FTP Connecting Window**.

## FTP Connecting Window

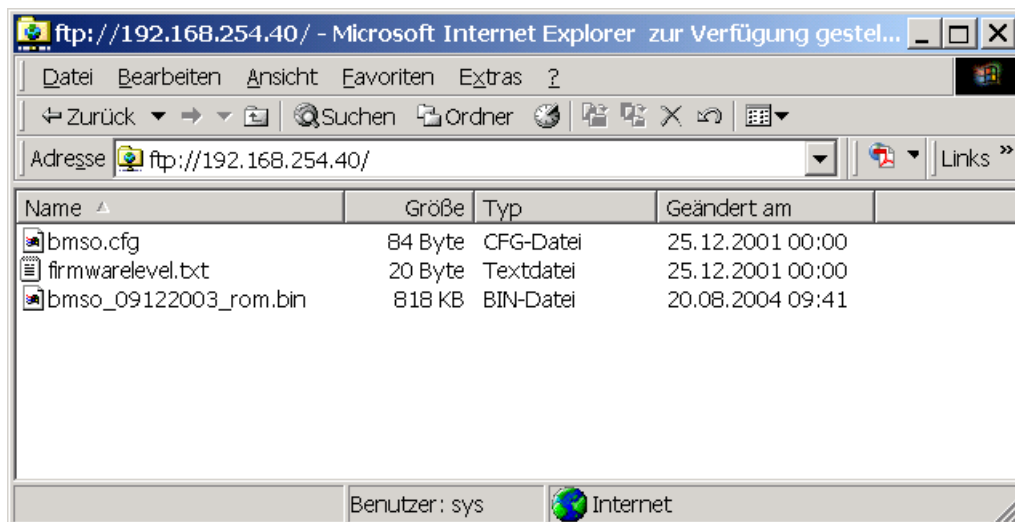


The new program file must be called 'XXXXXXrom.bin'. 'XXXXXX...XX' is normally the unit ID + Firmware Release Date. (e.g. bmso\_09122003\_rom.bin).

Copy the file per **drag and drop** into the ftp window to start the download.

Once the download is complete (Approx. 4 sec. after the FTP Transfer is finished), the new application program is copied to RAM. The program then restarts from RAM.

FTP transfer finished

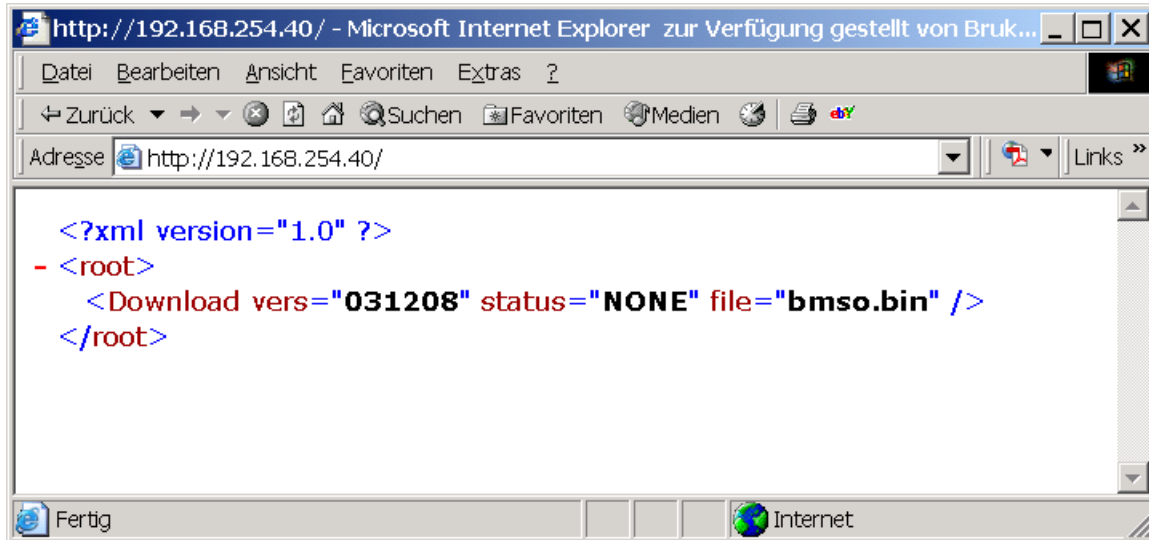


## FTP Download

Note: If you send an invalid file, the Status Page will be as follows:

You can use another browser window to check the status at any time.

Status Page for an Invalid programmed



This file will, of course, not be programmed.

Should something go wrong during the download you simply have to switch the unit off and then on again. It will start up in download mode ready for a new application program. **You may have to do this twice before it restarts!**

The only exception to this would be if you happened to be downloading an update to the download program and something were to go wrong. In this case the board would no longer operate and would have to be returned to Bruker.

Once the FTP Transfer is complete you can ping the unit as before. After a few seconds the unit stops responding. Some 3-8 secs after this the unit will be running in application mode and will respond once more.

The Ethernet Board download has now been completed.

### ***Ping a Unit to check the connection***

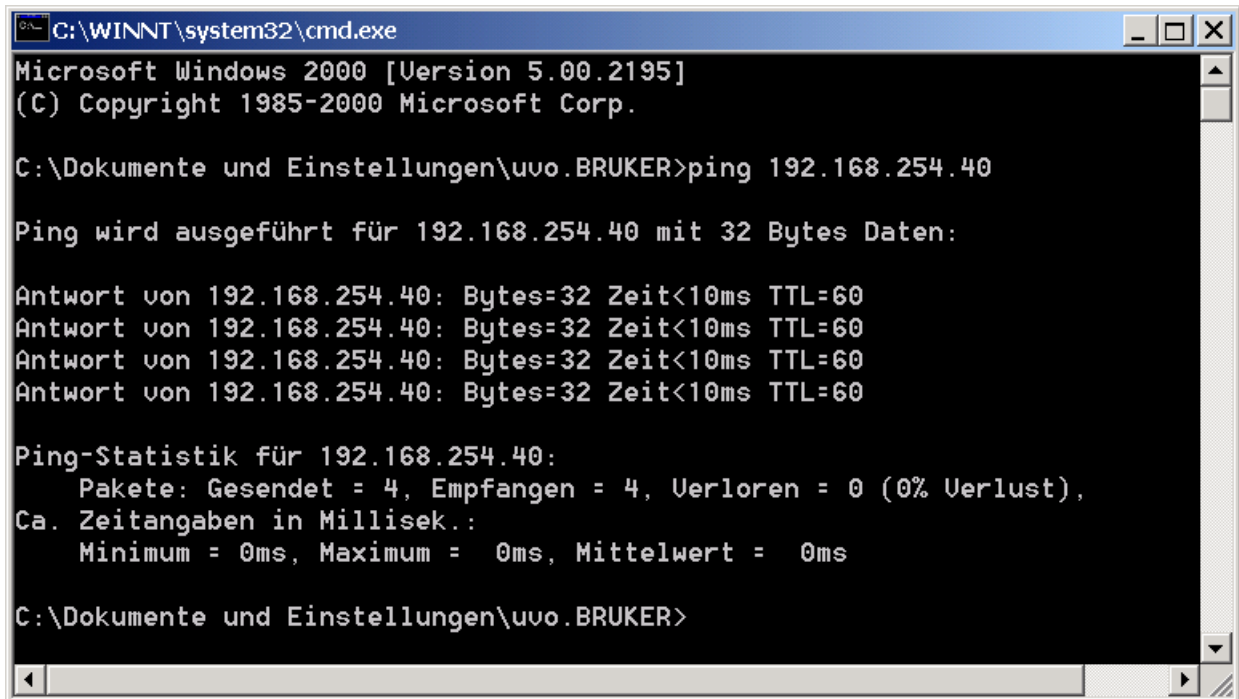
**11.2**

If you simply wish to check the ethernet connection to an unit without a Browser (IE..) open a DOS Box and enter the following.

**ping 192.168.254.40**

If the connection is OK the responds as shown below: (or at least in the installed Windows language version of this!)

## Ping the Unit



```
C:\WINNT\system32\cmd.exe
Microsoft Windows 2000 [Version 5.00.2195]
(C) Copyright 1985-2000 Microsoft Corp.

C:\Dokumente und Einstellungen\uvo.BRUKER>ping 192.168.254.40

Ping wird ausgeführt für 192.168.254.40 mit 32 Bytes Daten:

Antwort von 192.168.254.40: Bytes=32 Zeit<10ms TTL=60
Antwort von 192.168.254.40: Bytes=32 Zeit<10ms TTL=60
Antwort von 192.168.254.40: Bytes=32 Zeit<10ms TTL=60
Antwort von 192.168.254.40: Bytes=32 Zeit<10ms TTL=60

Ping-Statistik für 192.168.254.40:
    Pakete: Gesendet = 4, Empfangen = 4, Verloren = 0 (0% Verlust),
    Ca. Zeitangaben in Millisek.:
        Minimum = 0ms, Maximum = 0ms, Mittelwert = 0ms

C:\Dokumente und Einstellungen\uvo.BRUKER>
```



# Appendix

# A

## ***Valve Usage Information***

**A.1**

---

This appendix contains information and specifications on the valves used with the BMSO.

### ***The 6-Way Column Selector***

**A.1.1**

Vici Order Number: C5-1006EMTD-BRU

Bruker P/N: 85195

**SPECIFICATIONS:** 5000 PSI liquid

75°C max.

Metal Stator

Valcon H rotor

Port: 0.25mm

### ***The 6-Port 3L 2 Position Valve with Air Actuator***

**A.1.2**

Vici Order Number: C2-0006A

Bruker P/N: 85363

**SPECIFICATIONS:** 5000 PSI liquid

75°C max.

Metal Stator

Valcon H rotor

Port: 0.15mm

Vici Order Number: C1-1006  
Bruker P/N: 85991  
**SPECIFICATIONS:** 5000 PSI liquid  
75°C max.  
Metal Stator  
Valcon H rotor  
Port: 0.25mm



# Figures

<b>1</b>	<b>About This Manual</b>	<b>5</b>
Figure 1.1.	Declaration of Conformity .....	7
<b>2</b>	<b>Terms and Definitions</b>	<b>9</b>
<b>3</b>	<b>BMSO General Information</b>	<b>11</b>
<b>4</b>	<b>Preparation Before First Usage</b>	<b>15</b>
Figure 4.1.	A Typical Installation without a LC-NMR MicroBay Cabinet ..	15
Figure 4.2.	A Second Typical Installation without a LC-NMR MicroBay Cabinet. ....	15
Figure 4.3.	A Typical Installation without a LC-NMR MicroBay Cabinet with SPE .....	16
Figure 4.4.	A Typical Installation with a LC-NMR MicroBay Cabinet .....	16
Figure 4.5.	A Typical Installation with a LC-NMR MicroBay Cabinet and SPE .....	17
Figure 4.6.	A Typical Installation with LC-NMR /MS MicroBay Cabinet and SPE .....	17
Figure 4.7.	Standard Racks .....	19
Figure 4.8.	End Position Lock .....	19
Figure 4.9.	UV Cell on the Front Panel .....	21
Figure 4.10.	Location of the UV Cell 2 .....	22
Figure 4.11.	Fiber Optics to the UV Cell 2 .....	23
Figure 4.12.	Fiber Optics Connections on the Front Panel .....	23
Figure 4.13.	Schematic UV Cell Wiring .....	24
Figure 4.14.	Column Numbering in the BMSO .....	26
Figure 4.15.	Valve Numbering .....	27
Figure 4.16.	Waste Connector on the Front Panel .....	27
Figure 4.17.	BMSO Standalone Table Rack Front View .....	28
Figure 4.18.	BMSO Standalone Table Rack Rear .....	29
Figure 4.19.	BMSO Standalone Pneumatic Connection .....	29
Figure 4.20.	MicroBay Cabinet Front View .....	30
Figure 4.21.	MicroBay Cabinet Rear View .....	30
Figure 4.22.	BPSU36-2/BMSO Pneumatic Connection (only N2) .....	31
Figure 4.23.	BPSU36-2/BMSO Pneumatic Connection (N2 + Comp. Air) ..	32
<b>5</b>	<b>Operating Instructions</b>	<b>33</b>
Figure 5.1.	Location of the Leak Sensor behind the Front Plate .....	34
Figure 5.2.	Cooling System Connections .....	35
Figure 5.3.	Peltier Cooling Aggregate .....	36
Figure 5.4.	Recirculating Chillers .....	36
Figure 5.5.	Caution Concerning UV Radiation .....	37

Figure 5.6.	Caution Concerning Hot Parts and Liquids .....	37
Figure 5.7.	Caution Concerning High Voltage .....	37
Figure 5.8.	Location of the Front Panel Connections .....	38
Figure 5.9.	Location of the Rear Panel Connections (electrical) .....	38
Figure 5.10.	Location of the Rear Panel Connections (pneumatic) .....	39
Figure 5.11.	Location of Sensors, Column Holders, Cable Trench Cover	40
Figure 5.12.	Location of Boards and Power Supply .....	40
Figure 5.13.	Location of Pressure Reducer and Ventilator inside BMSO ..	41
Figure 5.14.	Location of Valves No. 2,3, and 4 .....	42
Figure 5.15.	Location of Valve No. 1 (Injection Valve) .....	42
Figure 5.16.	Location of Valves No. 5 and 6 .....	43
 <b>6 Service Information</b>		<b>45</b>
Figure 6.1.	Removing the Port Front Panel .....	48
Figure 6.2.	Unlock the Drawer .....	49
Figure 6.3.	Rheodyne Injection Valve and Fittings with Steel Capillary ..	50
Figure 6.4.	Vici Valves and Fittings Connections with Stainless Steel Capillaries .....	50
Figure 6.5.	Vici Valves and Fittings with PTFE Tubing Connections .....	51
Figure 6.6.	Vici Injection Valve and Fittings Connected with 1/32" Steel Capillary. ....	51
Figure 6.7.	Fittings and Ferrules on Front Plate Connector .....	52
Figure 6.8.	Fittings and Ferrules on UV cell s .....	53
Figure 6.9.	Valve Null Position .....	53
Figure 6.10.	Location of the Clamping Ring Allen Screw .....	54
Figure 6.11.	Removing the Valve .....	54
Figure 6.12.	Eliminating the Clearance .....	55
Figure 6.13.	Capillary Wiring Schematic .....	58
Figure 6.14.	Capillary Wiring External Valve1 .....	60
 <b>7 Serial Interface Control</b>		<b>61</b>
 <b>8 Cable Wiring</b>		<b>63</b>
Figure 8.1.	Jumper Settings on the BMSO Control Board only H5P3213B . .....	63
Figure 8.2.	Jumper Settings on the BMSO Control Board only H5P3213C . .....	64
Figure 8.3.	The Fan Connector X5 .....	64
Figure 8.4.	The BIS Connector X14 .....	65
Figure 8.5.	The BMSO Control Board Connections .....	66
Figure 8.6.	The Power Connector X9 and Remote Connector X20 .....	67
Figure 8.7.	BMSO SENSOR WIRING .....	68
 <b>9 Error Guide</b>		<b>69</b>
 <b>10 Embedded Web Server</b>		<b>71</b>
Figure 10.1.	Embedded Web Server Home (Status) Page .....	72
Figure 10.2.	Embedded Web Server (EWS) Service Page .....	77
Figure 10.3.	Device Information Page .....	78

Figure 10.4. Service Page .....79  
 Figure 10.5. The Operation Modes Page .....80  
 Figure 10.6. The Valves Positions and Variables Settings Page .....81  
 Figure 10.7. The Heater Settings Page .....82  
 Figure 10.8. The Miscellaneous Settings (Misc) Page .....83  
 Figure 10.9. The Message Page .....84  
 Figure 10.10.The Setup Page .....85

**11 FTP Download 87**

Figure 11.1. Switch to Boot Mode .....87

**A Appendix 93**



# Tables

<b>1</b>	<b><i>About This Manual</i></b>	<b>5</b>
<b>2</b>	<b><i>Terms and Definitions</i></b>	<b>9</b>
<b>3</b>	<b><i>BMSO General Information</i></b>	<b>11</b>
<b>4</b>	<b><i>Preparation Before First Usage</i></b>	<b>15</b>
<b>5</b>	<b><i>Operating Instructions</i></b>	<b>33</b>
<b>6</b>	<b><i>Service Information</i></b>	<b>45</b>
Table 6.1.	Cable Configuration in the BMSO .....	56
Table 6.2.	List of Major Parts in the BMSO .....	56
Table 6.3.	Labeling Used on the Capillary Wiring .....	57
Table 6.4.	Table of Internal Capillaries .....	59
Table 6.5.	Table of External Capillaries .....	60
<b>7</b>	<b><i>Serial Interface Control</i></b>	<b>61</b>
Table 7.1.	RS232 Interface Pin Connections .....	61
<b>8</b>	<b><i>Cable Wiring</i></b>	<b>63</b>
<b>9</b>	<b><i>Error Guide</i></b>	<b>69</b>
<b>10</b>	<b><i>Embedded Web Server</i></b>	<b>71</b>
Table 10.1.	Status Used on the BMSO Homepage .....	73
<b>11</b>	<b><i>FTP Download</i></b>	<b>87</b>
<b>A</b>	<b><i>Appendix</i></b>	<b>93</b>



