

AVANCE DMX/DSX Spectrometers

**Solids Experiments
User Manual**

Version 001

BRUKER

The information in this manual may be altered without notice.

BRUKER accepts no responsibility for actions taken as a result of use of this manual. BRUKER accepts no liability for any mistakes contained in the manual, leading to coincidental damage, whether during installation or operation of the instrument. Unauthorised reproduction of manual contents, without written permission from the publishers, or translation into another language, either in full or in part, is forbidden.

This manual was written by

Dr. Hans Förster

© September 23, 1996: Bruker Analytik GmbH

Rheinstetten, Germany

P/N: H9321

DWG-Nr: Version001

Contents

	Contents	iii
1	Hardware Description of High Power Components	7
1.1	Commonly Used Abbreviations	7
1.2	Main rack and operators desk	9
	Driver Transmitters for High Power Tube amplifiers	9
	SE-451 frequency generation and signal detection unit. .	10
	TCU and FCU's	11
1.3	HP-Cabinet	11
	HPCU, high power control unit	14
	High Voltage Power Supply	18
	Power Router	19
	High Power RF Transmitters (amplifiers)	19
	Pneumatic Unit, PU	24
1.4	Four Phase Modulator (4-PM)	25
1.5	High Power Preamplifiers, HPHPPr	26
1.6	FADC BC-133 and Filter Board FT-LP 4M	28
1.7	High Power Probes	30
	Design criteria for probes	30
	Probe parameters	30
	Short description of high power probes for DMX/DSX instru- ments 38	
	Standard bore high power probes	40
	Probe maintenance and repair	41
1.8	Software description	41
	Spectrometer configuration	41
	Experiment setup	43
	Pulse Programming	45
2	Standard Setup Procedures	49
2.1	RF Architecture of AVANCE Spectrometers	49
2.2	DMX RF wiring	50
2.3	DSX RF wiring	52
2.4	RF connections to the probe, Setup Menus	54
	RF wiring	54
2.5	MAS-PU and VT connections	61
	VT connections	61
	Safety precautions for extreme temperature operation: .	61
	Pneumatic unit connections	63
	MAS heat exchangers	63
	Standard setup for different probes	66
2.6	Operation of the MAS Pneumatic Unit, PU	70
	Configuration	70

	Preparation of the communication with the pneumatic unit .	
	71	
	Operation of the pneumatic unit	73
	Caveats:	75
2.7	Tuning the Probe	76
2.8	Tuning Transmitters	79
2.9	Useful Equipment	80
3	<i>CP-MAS Experiments with WB Probes</i>	83
3.1	Necessary equipment	83
	Hardware:	83
	Site requirements:	83
	Test samples:	83
3.2	Hardware setup	84
3.3	Experiment setup	84
	Transmitter setup (tube amplifiers only):	84
	Probe preshimming:	85
	Angle adjustment:	85
	C-13 observe and shimming:	85
	Adjustment of Hartmann-Hahn condition for CP	86
3.4	Standard experiments	87
	VACP setup	87
	TOSS setup:	88
	SELTICS setup:	88
	NQS setup:	88
3.5	Multinuclear setup	88
	General considerations	89
	Samples required are:	90
	General setup procedures:	90
3.6	Quadrupolar Nuclei	92
	Introduction	92
	Experimental procedures	92
3.7	Appendix:	97
	AU program angle	97
	Reference spectra	98
3.8	Advanced 1D and 2D Experiments	115
3.9	MAS Automation	115
4	<i>Wideline Experiments on DMX/DSX Instruments</i>	117
4.1	Necessary equipment	117
	Hardware:	117
	Test samples:	117
4.2	Hardware setup	118
4.3	Experiment setup on 2H	119
4.4	Experiment setup for other nuclei	120
4.5	General Setup Considerations	121
4.6	Appendix	123
5	<i>CRAMPS Experiments on DMX/DSX Instruments....</i>	131

5.1	Necessary equipment	131
	Hardware:	131
	Software:	131
	Test samples:	131
5.2	Hardware setup	132
5.3	Experiment Setup	133
5.4	Appendix	136
6	Troubleshooting	149
6.1	General	149
6.2	Establishing ethernet communication to the CCU	150
6.3	Test software for TCU, FCU and RCU	150
6.4	Test software for RS232 and RS485 controlled units	151
6.5	RF hardware troubleshooting.	151
	The signal is too weak or there is no signal	152
	The signal to noise is much lower than usually, but the spectrum looks otherwise correct	157
	The signal looks distorted	160
	Hunting spikes	161
	Problems with WOBB	162
6.6	SE-451 adjustments	162
	DC and quadrature adjustments	163
	Pulse output adjustments	163
	4-phase modulator adjustments	163
	Adding or changing transmitter boards.	163
6.7	Pulse program troubleshooting	164
6.8	Probe troubleshooting	165
	The probe does not tune	165
	The probe arcs	166
	The probe deadtime seems too long	166
	Acoustic ringing	166
	Figures	167
	Tables	171

Contents

Hardware Description of High Power Components

1

Commonly Used Abbreviations

1.1

Table 1.1. Commonly Used Abbreviations

4-PM	4-phase modulator control board, fast phase shifter
ACB	Acquisition control board supervising low power transmitters
ADC	Analogue to digital converter
AQR	Acquisition rack containing SADC or HADC, FTL-4M,ASU, AVANCE router(s), 4-PM, ACB
AQX	Acquisition control computer containing CCU with RS-232interface, TCU, FCU's, RCU(s), FADC, GCU
ASU	Amplitude setting unit
BBIS	BRUKER board identification system
B-LAH	BRUKER linear amplifier for high range frequencies
B-LAX	BRUKER linear amplifier for the X-frequency range
B-LAXH	BRUKER linear amplifier for full frequency range (two amplifiers in one housing)
BSMS	BRUKER smart magnet control system (shim, lock and HR pneumatic controls)
Cavity	High power amplifier using a cavity resonator
CCU	Communication control unit, formerly CPU-4
DAC	Digital to analogue converter dB decibel, logarithmic unit of attenuation
DDS	Direct digital synthesizer
DRAM	Dynamic random access memory
DSP	Digital signal processor
FADC	Fast ADC BC-133
FCU	Frequency control unit

Hardware Description of High Power Components

Table 1.1. Commonly Used Abbreviations

FTLP-4M	Audio filter board for filter widths from 125 kHz-4 MHz
GCU	Gradient control unit
HRD-16	High resolution 16 bit ADC
HADC	High performance 16 bit ADC
HPCU	High power control unit
HPHPPR	High power high performance preamplifier for solids applications
HPPR	High performance preamplifier for high resolution applications
HP	High power
HR	High resolution in liquids
HT	High temperature (probe
HV	High voltage
IF	Intermediate frequency =ZF
LAB	Level adaptor board
LO	Local oscillator board in SE-451
LT	Low temperature
Mixer	Frequency mixing device
Multiplexer	The unit in the preamplifier which directs the pulse into the probe and the NMR signal from the probe to the preamplifier
PAL	Programmable array logic
preamp	Preamplifier
PROM	Programmable read only memory
PU	Pneumatic unit for MAS applications
PS	Power supply
RADC	Routine ADC, standard ADC, also called SADC
RAM	Random access memory
RCU	Receiver control unit
R-FT	SE-451 receiver board
RT	Room temperature
SADC	Standard 14-16 bit ADC, also called RADC
SB	Standard bore (probe) for 54 mm bore magnets
SE-451	Sende-Empfangseinheit 451 MHz IF
SMD	Surface mounted device

Table 1.1. Commonly Used Abbreviations

SRAM	Static RAM
SWB	Super wide bore (probe) for 150 mm bore magnets
TC	Thermocouple
TCU	Timing control unit
T-FH	Transmitter board for proton frequency (SE-451)
T-FX	Transmitter board FX for all NMR frequencies (SE-451)
Triple mixer	Proton frequency generator
Tx	Transmitter, RF amplifier
Vpp	RF peak-to-peak voltage
VTN	Probe for standard VT range applications
WB	Wide bore (probe) for 89 mm bore magnets
WVT	Probe for wide range VT applications
WL	Wideline (probe)
ZF	Zwischenfrequenz (intermediate frequency, IF)

Main rack and operators desk

1.2

The main rack and operators desk will be described here only with respect to components which are relevant for solids spectroscopy:

SE-451 („Sende/Empfangseinheit, transmit and receive unit, operating with a 451 MHz intermediate frequency for detection.

BLAX and **BLAH** or **BLAXH** driver transmitters.

TCU Timing Control Unit and **FCU** Frequency Control Units, both located in the AQX rack

BC-133 FADC, fast analogue to digital converter, located in the AQX rack next to the **RCU** (Receiver Control Unit)

FTLP-4M analogue filter board, located in the AQR rack next to the standard „slow“ ADC (SADC or HADC)

4PM fast analogue orthogonal phase shifter, located in the AQR rack in the right-most slot.

Driver Transmitters for High Power Tube amplifiers

1.2.1

DMX and DSX instruments are identical in hardware except for the driver transmitters. The DSX uses driver transmitters which are designed to solely drive the high power tube amplifiers. The tube amplifiers require about 15-20 W of drive power for the X-amplifier (range 109Ag up to 31P) and about 25-35W for 1H/19F amplifier for frequencies up to 300 MHz. For 400 and higher frequencies, cavity transmit-

ters are used which require up to 50 W of drive power. This driver transmitter is the B-LAXH which contains 2 separate amplifiers with 25/60W for the X and H channel. This amplifier does not provide sufficient power for standard high resolution experiments. In a DMX instrument, separate B-LAX and B-LAH transmitters are used for high resolution experiments and to drive the high power amplifiers. Since the output power from these amplifiers is higher (300W for X, and 80-150 W for the 19F/1H/3H range), the drive power levels must be set to higher attenuation. If the high power X-transmitter is a linear solid state amplifier, the drive levels are much lower and a driver amplifier is not required. These units are driven from the ASU (Amplitude Setting Unit) directly.

⇒ **Never feed higher RF levels (i.e. from a drive amplifier) into such an amplifier- this may mean destruction of the input stage.**

SE-451 frequency generation and signal detection unit.

1.2.2

There are several versions of SE-451 units which differ in the following respects:

Receiver bandwidth and deadtime.

In DSX instruments and DMX instruments with full high power capabilities, 2 separate quadrature audio channels are available.

1. The standard audio channel

Is used for spectral windows up to 150 kHz (i.e. high resolution experiments of liquids and solids). The audio bandwidth is 1 MHz, the deadtime is below 2 usec. The signal voltage is up to +/- 5 Vpp depending on the receiver gain setting. The output impedance is 1 kOhm. This output is matched to the available range of „slow“ digitizers:

SADC (resolution 14-16 bit, 3.3 usec max. sampling rate), standard digitizer for DSX/DMX.

HADC (resolution 16 bit, 2.5 usec max. sampling rate), optional

HRD-16 (resolution 16 bit, 2.5 usec max. sampling rate), delivered until about 10/94

2. The broadband audio channel

Is used for spectral windows higher than 150 kHz, (i.e. wideline experiments of solids or experiments which cover a wide chemical shift range). The audio bandwidth is 4 MHz, the deadtime is below 1.5 usec. The signal voltage is up to +/- 1 Vpp depending on the receiver gain, the output impedance is 50 Ohms. This output is matched to the fast digitizer, BC-133. In older SE-451 units delivered for instruments without full solids capabilities, this channel may not be available.

Number of transmitter channels, frequency range of transmitter channels.

Older SE-451 units have 2 transmitter channels, one for proton frequency only (T-FH board), the other (T-TX board) for all NMR frequencies. Newer units may have up to 3 transmitter channels (1T-FX, 1-T-FH plus an optional second T-FX board).

⇒ **N.B.: phase coherent observation can only be done on frequency channels that are generated on either a T-FX or T-FH board.**

If more frequency channels (synthesizers plus FCU's) than SE-451 transmitter boards are available, these channels can only be used for pulse generation, not

for observation. Optionally, the T-FH board can be replaced by a T-FX board in order to make the frequency range broadbanded.

⇒ ***N.B.: The frequency generation scheme must be configured according to the available hardware, see software section below.***

This is necessary, because the synthesizer frequency output must be set to

NMR-Frequency minus 440 MHz

if a transmitter board is used (either T-FH or T-FX), or to the

NMR-frequency

if the pulses are not generated in a transmitter board but rather in the ASU, bypassing the SE-451. In that case, the highest available frequency is given by the synthesizer frequency range (619.999 for a PTS 310 with doubler).

Availability of fast orthogonal phase shifts.

DMX/DSX instruments with full solids capabilities have 440 MHz phase shifters incorporated in the SE-451 mother board. These phase shifters are controlled by the 4-PM modulator board in the AQR rack.

⇒ ***N.B.: SE-451 units with this phase shifter hardware cannot be operated without a 4-PM board.***

The phase shifters require a control voltage that is supplied by the 4-PM board.

TCU and FCU's

1.2.3

The TCU and the FCU's do not differ from units in standard high resolution instruments, so only a couple of solids related features will be described. For solids instruments, the TCU should have the part number H 5811.

The FCU's have undergone an upgrade concerning the 4-phase modulator operation and should be EC level 6 or higher to operate with XWIN-NMR. UXNMR 941001.4 or older software requires ECL 04 FCU's. In general, all high power hardware is RS 232 controlled via the HPCU, however there is also a couple of fast signal outputs and inputs. These are:

6 external pulse channels, available at the power router BNC connectors that are transmitted via a SCSI cable from TCU connector T1 to the power router PR1 connector. These TTL pulses are active low (-4.5 V) and can be programmed as described in the software section

2 trigger inputs to SMB connectors labelled TRIG0 and TRIG1 at the TCU

2 additional trigger inputs TRIG2 and TRIG3 that are included in the TCU T1 connector. TRIG3 is hardwired through the power router burndy connector PR2, pin U, to the external trigger output of the MAS PU spin rate counter. TRIG2 is used for Stray Field solids imaging. and is available at burndy connector PR3 pin B

HP-Cabinet

1.3

The high power cabinet houses the:

Pneumatic Unit (PU)

High Power Control Unit (HPCU)

and 2 high power transmitters with all associated hardware:

- Power router
- High voltage power supply

Figure 1.1. DMX/DSX HP Cabinet 100-400MHz

DMX/DSX HP CABINET

100 - 400 MHz

HPCU behind POWER ROUTER DIGITAL

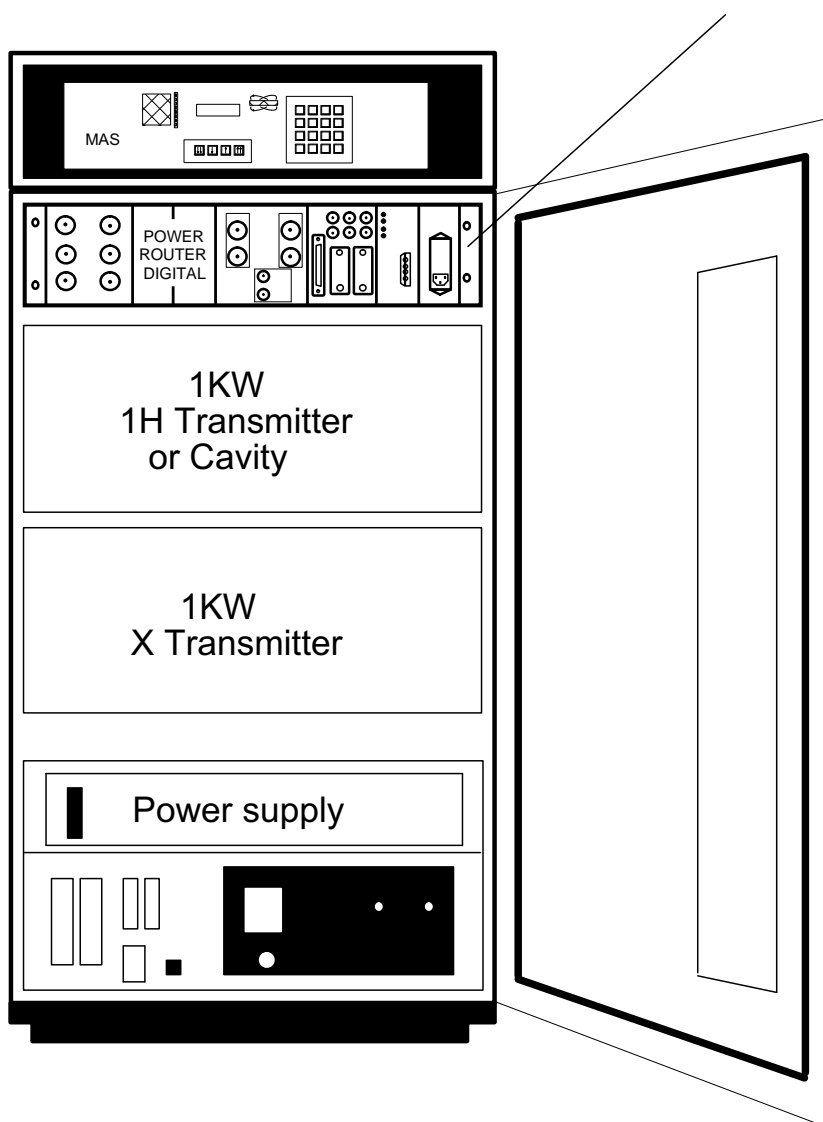

[NIL H:\Prelim\Projects\hpower\blochpc_dsx2.ds4](#)

Figure 1.2. DMX/DSX HP Cabinet AMT 500-600 MHz

DMX/DSX HP CABINET AMT

500 - 600 MHz

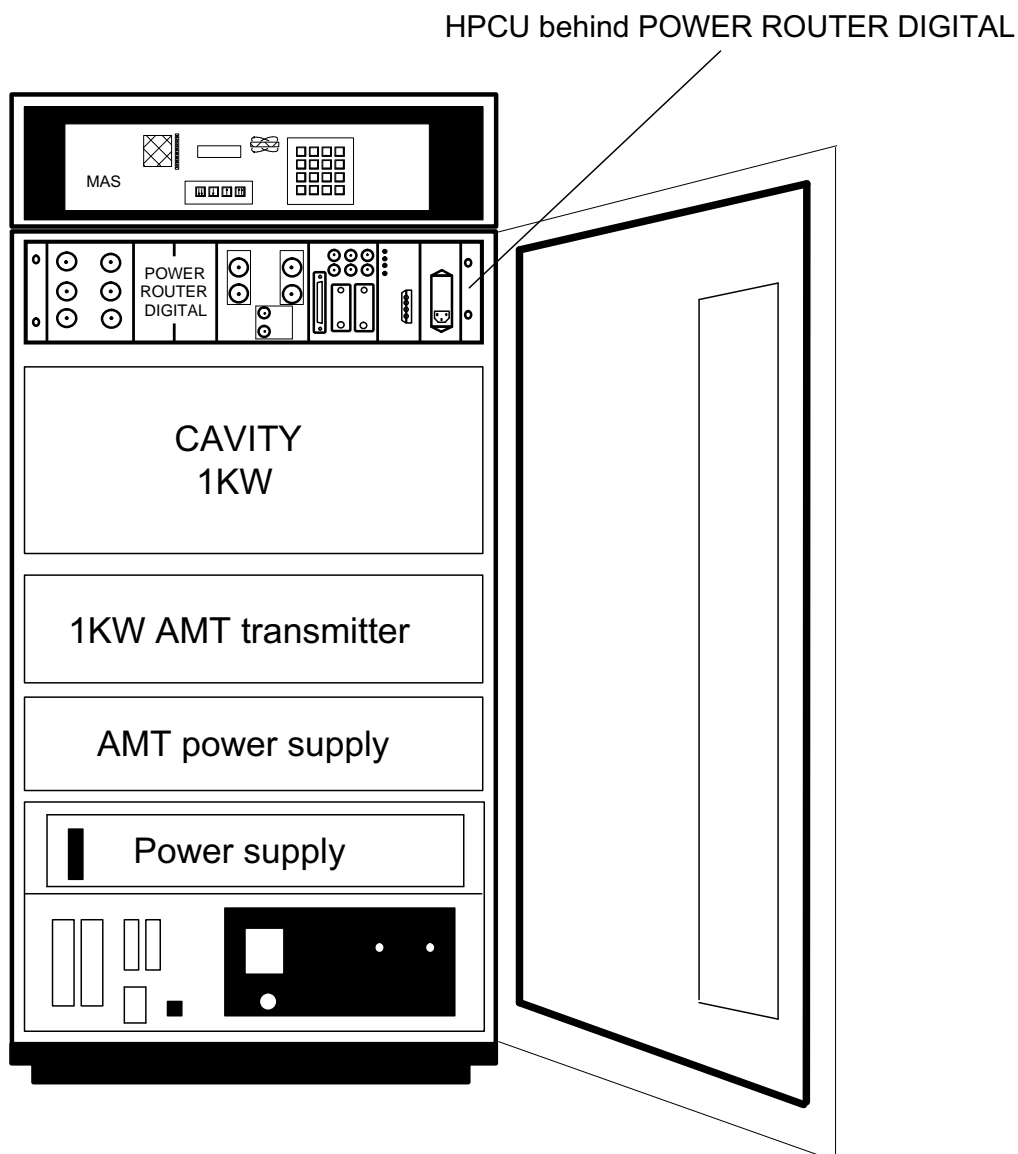

NIL 19.12.94 Prelim\Projects\hpower\bloc\HPC_DSX1.DS4

The high power control unit (HPCU) serves as a central controller for all other hard-ware inside the HP cabinet and also for the 4-phase modulator, 4-PM that is located in the main rack inside the AQR. These functions include:

- RS 232 communication to the CCU via RS 232
- communication to the HPCU control keypad located at the operators desk
- control of the pneumatic unit via RS 232
- control of the HP router settings, display of the forward/reflected power via the HPCU keypad
- control of the high power transmitter tuning and grid voltage (gain) setting
- control of the high voltage power supply.

Please refer to the section hardware setup for wiring and to the section software for control commands. Detailed hardware descriptions are available in the DMX, DSX High Power Manual.

Figure 1.3. DMX/DSX HPC 100-400

DMX, DSX HPC 100 - 400

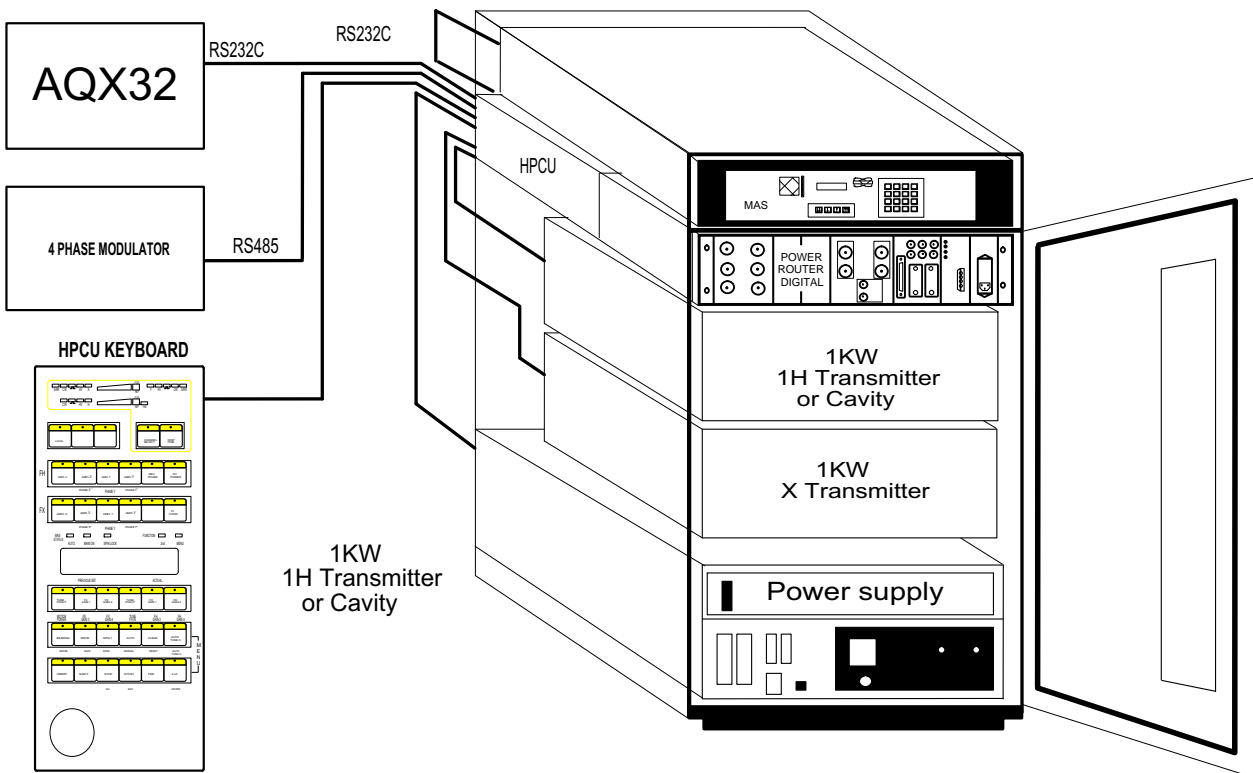

NIL 19.12.94 HPC_DSX3.DS4

HPCU keypad

The HPCU keypad allows to read and set all functions that are controlled from the HPCU. Furthermore, the power display on top of the keypad allows to monitor forward and reflected power at the HP transmitter outputs in a similar way as the display at the BSMS keypad does for the driver transmitters. In addition, there are a few supervision LED's.

- a. Forward/reflected power indication.

Two green (red) rows of LED's indicate forward (reflected) power for sometime after a pulse has been executed. This information comes from the high power router which has directional couplers at the X-transmitter output and the 1H/19F transmitter input and output. The toggle button CHANNEL SELECT allows to toggle between forward and reflected display on any of the two standard transmitters. (If an AMT transmitter is present, the forward/reflected meter can also be used). If the pulse power is low, no LED may come on. In that case, use the DISP FINE button to increase sensitivity. N.B.: The number of LED's indicates only the pulse power for the first pulse in the sequence. The display is not fast enough to indicate any power change during the pulse sequence. Also, short pulses will produce a weaker display than long pulses. The forward/reflected indicator is only active for the 2 standard transmitters.

- b. Control LED's.

There is a number of control LED's for 3 transmitters. The ERR LED will come on if an error on the HPCU occurs. The CW LED is only active for AMT transmitters which can be switched between pulse and CW operation. The gate symbol indicates if a pulse is gated on. If this LED does not come on, AUTO transmitter tuning is not possible. The LED HV indicates that the high voltage is present for this transmitter. The X, H, or Y LED indicates that those transmitters are present and active.

- c. 4 phase modulator buttons: These buttons allow adjustment of the 4-phase modulator phase and amplitude adjustments when the LOCAL or 4PH ENABLE button is activated. The buttons FH POWER and FX POWER are not active and produce a HPCU error message.
- d. PU supervision LED's MAS STATUS: These LED's are not active.
- e. FUNCTION LED's: These LED's indicate if the 2nd function of any push-button is activated, the MENU LED indicates when the MENU mode is active.
- f. The display shows the previous value and the actual value of any parameter activated by a push-button. Modification of this parameter is possible with the rotary shaft encoder knob.
- g. The row of push-button's (gray) below the display window gives access to the transmitter tune and gain parameters.
- h. The AUTO TUNE X/H button (gray) allows auto-tuning of the X and 19F/1H transmitters. Refer to section II, Standard Setup procedures for explanation.
- i. The MAS buttons (black) refer to the corresponding buttons at the PU key-pad and are currently inactive except for the SPIN1 button which allows to read and set the spin rate when the PU is in remote mode and no UXNMR MAS command is active.
- j. The gray STD BY button deactivates any selected button, or, in MENU mode, goes one MENU level back. The FINE button sets the shaft encoder step size to fine/coarse. The step size can be modified in the MENU mode. The red

Hardware Description of High Power Components

MENU button, when pressed together with the AUTO TUNE X button allows to enter the MENU mode.

- k. MENU mode: In the MENU mode level 1, the keyboard parameters (step size) can be modified. Level 6 allows adjustment of the 4-phase parameters of the 3rd channel if available. The 4PH ENABLE button must be active and the service security code must be entered.

Figure 1.4. HPCU Keyboard
HPCU KEYBOARD

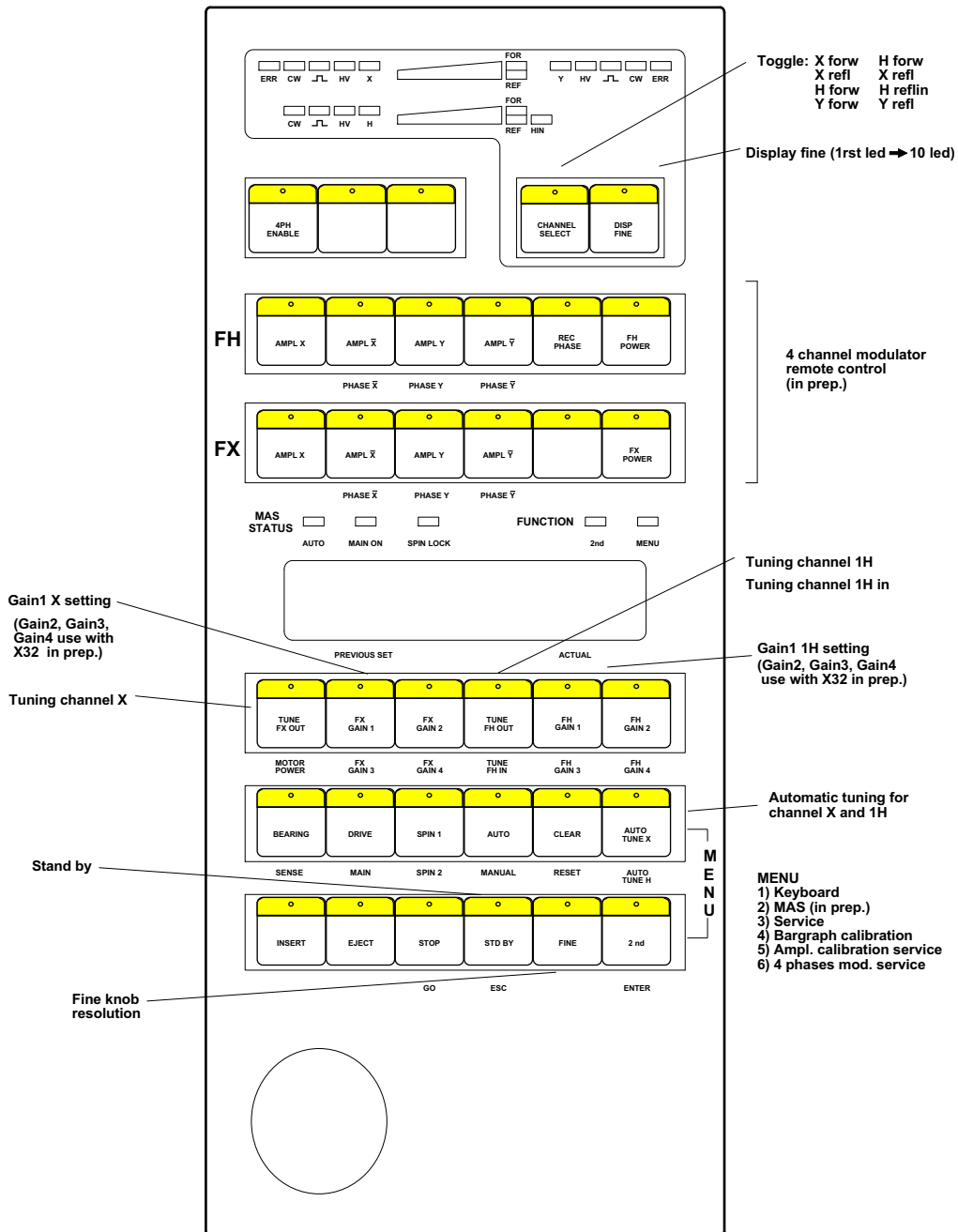

ESH 20.10.94 HPCUKEYB.DS4

Control of the Pneumatic Unit (PU).

Since the pneumatic unit contains its own microprocessor controller, the HPCU serves only to transmit the RS 232 control commands from the CCU/host computer. Alternately, the PU may be connected directly to one of the available CCU RS232 ports. Refer to the software section for the installation procedure.

In newer instruments, no HPCU is necessary. The PU must therefore be connected to the CCU directly. It is recommended to use this setup, since only this port will be maintained with further software developments.

Control of the HP transmitters.

- a. HP router controls: HPCU units of ECL (Engineering Change Level) 02 starting from serial No. 0046 may be modified (standard for Ser. No. higher than 0071) to switch the high voltage power supply on and off via NMR software or HPCU test software. In DMX instruments, the RF output from B-LAX and B-LAH transmitter can be routed into the high power amplifiers (if a linear high power amplifier like an AMT 3200 is present, the ASU RF output will be routed either into the B-LAX 300 or into the AMT 3200). In HPCU's with ECL 01, these controls are manual switches. The router controls cannot be set from the HPCU keypad, but only from within the NMR software or the HPCU test software.
- b. Transmitter tuning controls: Tube amplifiers require output tuning (X-range-tube amplifiers) or input and out-put tuning (1H/19F amplifiers). The tuning operation involves a stepper motor that sets the position of a tunable rotary capacitor. The position of this capacitor is read at the HPCU keypad when pressing the corresponding push-button Tune Fx out, Tune FH out or Tune FH in. The numbers displayed range from 0 (zero) to 1200 for Tune FX out). For 1H/19F transmitter up to 360 MHz, these numbers range from 0 to 400 for Tune FH out and from 0 to 1200 Tune FH in. For cavity transmitters (376 MHz and up), the Tune FH in values range from 0 to 3600 and the Tune FH out values from 0 to 3600. The numbers are arbitrary and correspond to nothing else but a physical position of a tuning capacitor or a cavity wall. For X-range transmitters, there are usually 2 positions yielding the same output power since the tuning capacitor has a plane of symmetry. A general tuning procedure will be given in chapter II. If a linear high power solid state transmitter like the AMT 3200 is used for the X-frequency range, no transmitter tuning is required and the Tune FX out button has no effect.
- c. Transmitter gain control: The output power of amplifiers can be controlled by the input power level or by the amplification factor. See the section on HP amplifiers for more detail. With X-range tube amplifiers and 1H/19F tube amplifiers up to 360 MHz, the output power can be controlled between about 70 Watts and ≥ 1 kW by the second grid voltage. This voltage can be set between 0 (min. power) and 400 V (maximum power) by means of the HPCU keypad buttons XGAIN 1-4 and HGAIN 1 - 4. XGAIN 1 and HGAIN 1 are available for all units. To activate levels 2-4 on both transmitters, the engineering changes ECH 0196501966 and 01967 must be executed. Cavity transmitters and linear solid state transmitters (AMT 3200) are solely controlled via the input voltage. The values for XGAIN1-4 and HGAIN1-4 range between 0 and 4095. These numbers just correspond to the output power and are not calibrated in Watts. The pulse-program may be written such as to switch between Gain 1-4 within less than 2 μ sec 1 fall gain levels are active (see software section for command syntax).
- d. 4-Phase Modulator controls: 4-phase modulator phase shifts are initiated by the PH1 and PH2 FCU outputs on every available SE-451 transmitter channel (for direct channels, analogue fast phase shifting is not available). The ampli-

tude and phase adjustment for the 4 individual phases are adjustable via the HPCU keypad buttons 4PH ENABLE (in older units labelled LOCAL), and the FH and FX AMPL/PHAS buttons. For the 0 degree phase shift (X) only the amplitude is adjustable since its phase is the reference for all other phases. The 90 degree phase shift is labelled Y, X bar and Y bar are 180 and 270 degree phase shifts. The receiver reference frequency phase can be set by REC PHASE. All adjustments require that the 4PH ENABLE button be activated. If no adjustments are made, the 4PH ENABLE will be switched off after a few seconds. This is to prevent accidental misadjustment. The adjustment range is given in numbers between 0 and 4095 (12 bit). The adjustment procedure is given in the CRAMPS setup manual, part V. The adjustment parameters can be stored to disk as described in the software section. In newer instruments without HPCU, the 4-PM is controlled via the second RS485 port from the CCU. The setting is done from the ed4ph window.

High Voltage Power Supply

1.3.2

⇒ ***This unit should never be opened and/or serviced by anybody without appropriate training. LETHAL HIGH VOLTAGE IS PRESENT!***

The high voltage power supply is located in the high power cabinet. This unit supplies all voltages for the high power transmitters. These voltages are 6.3 V cathode heating for both transmitters, 400 V grid voltage for both transmitters, and 2.5 kV anode voltage plus several other voltages required internally and for the X tube amplifier grid driver.

The high power cabinet is connected to a 380 V 3 phase socket separately from the main rack. The HPCU, MAS-PU and Power Router are powered from 220V sockets at the rear side of the high power cabinet and can be switched on with separate switches. The power router supplies a 24 V AC voltage to a relay inside the HV power supply to turn it on. In addition, there are 4 mains circuit breaks at the HV power supply front side which must be up. Early systems may still have manual switches at the power router controller to power up the HV and to switch the relays for RF-pulse routing. These units should be upgraded for software control via the HPCU. The HV power supply has two front doors. The upper one has a window for voltage supervision LED's. N.B. not all LED's must be on in all instruments.

⇒ ***DO NOT OPEN THIS DOOR- LETHAL HIGH VOLTAGE PRESENT!***

The lower dark plexiglas door shields the high voltage cable connectors and the HV fuses. N.B.: when AMT transmitters are present, only one HV cable and fuse is used! A red LED below the HV cable indicates that the 2.5 kV voltage is on. This is also indicated by a green LED labeled HV at the HPCU keypad. To change HV fuses (1A or 1.25 A), the HV power supply must be turned off (power router mains switch) Open the door only 1 min. thereafter.

⇒ ***N.B.: The door must be properly shut with 2 thumb screws, otherwise the HV will not come on.***

When the HV power supply is turned on (power router on), there is an approx. 3 min. delay until a noticeable click indicates that the HV is actually up. This will only occur if the fans in both tube amplifiers produce enough cooling gas flow to activate safety switches. Check the filters on both amplifiers if the HV does not come on.

The power router serves for several purposes:

- It supplies the 24 VAC to turn the HV power supply on
- It receives the 6 external pulses from the TCU
- It receives the MAS trigger signal from the PU and transmits it to the TCU
- It holds the directional couplers for the forward/reflected power display and transmits these signals to the HPCU
- It holds the relay/pin diode modules that allow to switch between pulse output from the HR driver transmitters to pulse output from the HP transmitters. In DSX instruments, the driver transmitters are directly wired into the HP amplifiers since these transmitters are only used as drivers.
- It receives the power on and routing signals from the HPCU (see software section for a command overview).

In newer instruments using linear B-LAX 1000 and B-LAH 1000 transmitters, no power router is necessary since the routing (if necessary for high resolution experiments, DMX instruments only) is done in the transmitters.

The high power transmitters amplify the driver pulse output to the power levels required for solids experiments. There are several types of high power amplifiers depending on the required frequency range and experimental requirements.

General properties of transmitters, transmitter types

Transmitters can be classified in several ways:

- by the amplification device: tube or solid state (transistor) amplifiers
- by their amplification characteristics: linear (class A or AB) or nonlinear (class B or C)
- by bandwidth: broadband or selective
- by their operation: CW or pulse amplifiers. In pulsed NMR applications, CW is only applied at moderate RF levels where heating problems are acceptable. For short high power pulses, short pulse rise and fall times are required.

Common principles apply to all types of amplifiers:

- amplification from RF levels of 1 Vpp (typical synthesizer output voltage) to 625 Vpp (corresponding to 1 kW of RF power) cannot be achieved with a single active component, therefore chains of drive stages must be used to cover this over 600 fold amplification. In general, a transistor will amplify by 6-12 dB depending on its bandwidth and circuitry, whereas a tube will amplify between 10 and 20 dB. In a selective amplifier, higher amplification can be achieved.
- for NMR applications, the input and output impedance must be 50 Ohms by convention (not by necessity). Internally, however, there may be different impedance's which at some point must be transformed into 50 Ohms.

Hardware Description of High Power Components

- not only the input signal, but also the input noise is amplified, amplification will add noise which will be also amplified if added in early stages.
- the efficiency (power in/power out) varies over a wide range between different types of amplifiers, efficient cooling is always required. A solid state (transistor) amplifier will have about 30-60% efficiency, a tube amplifier between 40 and 70%. Undesired heating effects will cause problems especially in CW operation or with long pulses.

Figure 1.5. Possible pulse errors

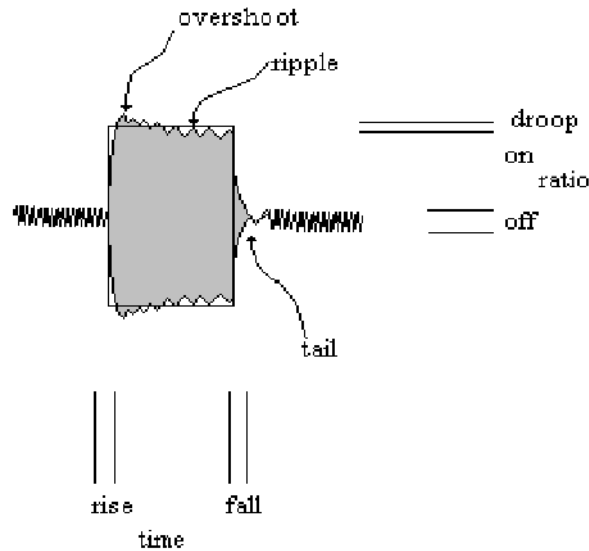

The drawing exemplifies the usual deviation of real RF pulses from the ideal rectangular shape. Rise and fall time are usually measured between 10 and 90% of the peak amplitude. The on/off ratio is measured in dB, droop, ripple and overshoot in% of the pulse pp (peak to peak) voltage. Most important for good performance of short excitation pulses is a symmetric pulse shape with little or no visible overshoot and ripple. Rise and fall times are not much of a problem since the component with the smallest bandwidth (which determines the relevant rise and fall time) is usually the probe. For long pulses or pulse trains, the droop becomes the most important parameter. The on/off ratio is always important since residual noise or even RF output will lead to increased noise in the spectrum or artifacts (spikes). Low frequency ripple usually comes from insufficient power supplies, high frequency ripple from RF impurities. The first may lead to unstable pulses, the latter is usually filtered out by the probe and presents no major problem.

Comparison of different transmitter types

Solid state vs. tube amplifier:

Solid state amplifiers usually work at lower voltages with impedances of 50 Ohms throughout and therefore require high currents, whereas tube amplifiers amplify at high voltage and low current at impedances much higher than 50 Ohms which in the output stage must be transformed down to 50 Ohms. This means in general, that tube amplifiers which require an impedance transformation, will cover a narrower frequency range than the intrinsic bandwidth of the amplification tube. To

cover a wide frequency band, these amplifiers must be tuned to every NMR frequency. Transistor amplifiers need not be tuned. Tubes do not heat up much higher during a pulse, so there is little change of amplification during a pulse. A transistor, however, will heat up substantially during a pulse and therefore change amplification. This results usually in a much higher pulse droop. Solid state amplifiers are very sensitive against impedance mismatch (mistuned probe) and require mismatch protection, whereas tube amplifiers are very tolerant against mismatch. A drawback of tube amplifiers is that tubes age and lose power. With heavy use of long pulses (mis-tuned-MAS), the tube lifetime is about 1 year, then the tubes should be replaced if the power output becomes insufficient. The tube change is usually easy. In contrary, transistor amplifiers will last much longer with stable power output, unless there is a mismatch accident which usually kills some final stage transistors. Then the repair costs are usually very high.

Broadband vs. tuned narrowband amplifiers:

Since tuning is not required, the broadband amplifier is easier to use, shorter rise and fall times of broadband amplifiers are usually irrelevant.

Transmitter linearity:

Usually, the linearity of a transmitter is factory preset. A linear amplification is achieved by pre-polarizing the grid of a tube or the base of a transistor with a DC voltage to an optimum value, as visualized in the following diagrams.

Figure 1.6. Linear Amplification

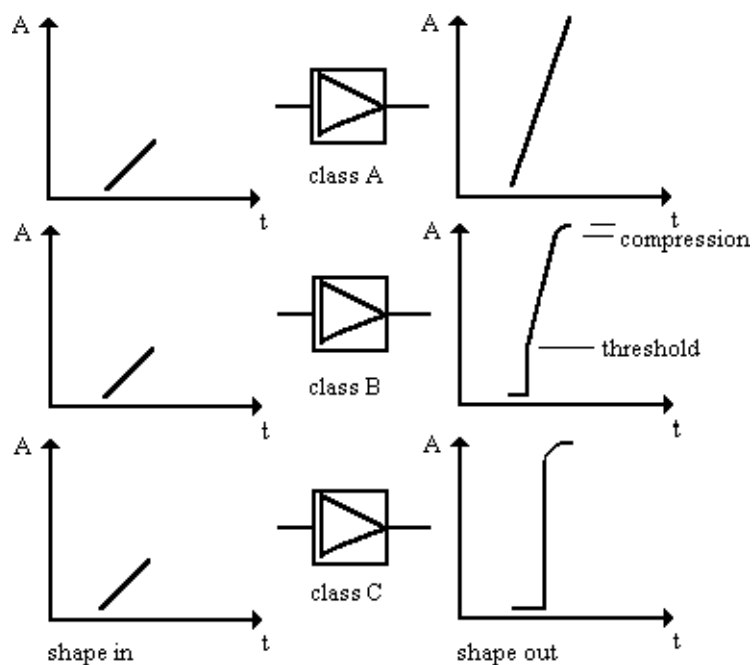

Linear amplification means that the output voltage of a linear amplifier truly reflects the shape of the input signal and that a small input signal will not be suppressed like in a nonlinear class B or C amplifier, if it falls below the threshold voltage. Linearity does however never extend over an unlimited range. At high drive voltage, a class A amplifier will go into compression, and very small signals will also be suppressed and /or distorted. The range in which the linear amplifier will amplify linearly is called dynamic range. For most amplifiers, this range will not exceed 60 dB. Tolerating some distortion, the total range will be about 100 dB.

It is obvious that shaped pulses must be linearly amplified to yield an appropriate excitation profile. There are, however, some differences in the use of class A, AB amplifiers compared to class C amplifiers. Where-as a class C amplifier will only draw current during the pulse, a linear amplifier will always have an anode- or emitter current flowing. This normally means that the power supply (PS) must be very powerful and the cooling very efficient.

For amplifiers of 1 kW in class A, this would roughly require a 2 kW PS and 1 kW of constant heating. Therefore, linear amplifiers are always blanked when no pulse is executed. When blanked, the bias voltage to base or grid is switched off. In addition, the transmitter input and output may be gated off. During the blank time, the amplifier draws less current and the power supply will recover. Also, the transmitter does not produce noise at the output which it does when unblanked. In a class C amplifier, this noise never exceeds the threshold voltage and therefore, there is no noise at the output (except during a pulse). Also, class C amplifiers do not draw current unless a pulse is on. This means that blanking/unblanking is not required. Usually, a +/- 5V DC pulse must be supplied prior to the gate and RF pulse to unblank a linear amplifier. Depending on the power output and design of the amplifier, this pre-delay must be between 0.5 and 3 usec. When the unblanking of a linear amplifier is programmed explicitly (see software section), one has to take into account that the pulse droop begins at the same time. Some linear amplifiers have a CW mode. In this mode, the amplifier is unblanked and in the linear mode. The maximum power output is then usually 10-20% of the maximum pulse output, and the noise is constantly on.

The noise must in that case be suppressed by filtering, external blanking devices or a few pairs of crossed diodes. Comparing linear class A/AB amplifiers and class C amplifiers, advantages and disadvantages are:

Advantages of linear amplifiers:

- shaped pulses can be precisely amplified over a dynamic range of about 60 dB as long as the amplifier is not driven into saturation.- changes in the power output can easily be achieved by changing the input voltage (where it can be achieved more rapidly and more easily)

Disadvantages of linear amplifiers:

- blanking is mandatory and must precede the pulse- any distortion of a pulse input will be amplified- the pulse droop is usually noticeable, so the RF power at the beginning and the end of the transmitter unblank period is noticeably different.

Advantages of class C amplifiers:

- blanking is not required
- by driving the amplifier close to saturation, pulse tops can be flattened, instabilities of the pulse input will be reduced

Disadvantages of class C amplifiers:

- fast changes of power output are not easily achieved
- shaped pulses cannot be executed without major distortions

Transmitters used in DMX/DSX instruments

As pointed out in a previous chapter, there are driver amplifiers (in the main rack) that are designed to work either as drivers for the high power amplifiers only (B-LAXH 60, used in DSX instruments) or that work as transmitters for high resolution and routine CP/MAS applications or as drivers for the high power amplifiers

(B-LAX, B-LAH amplifiers, used in DMX instruments). They all work in linear mode.

The frequency ranges cover the X-nucleus range (B-LAX) or the 19F-1H-3H range (B-LAH). Please refer to the manuals/spec sheets for performance specs. Usually, the longest pulse at full drive power is 500 msec for the H-range where they are used for decoupling and 20 msec for the X-range(100 ms optional).

Depending on the required frequency range, there are several high power amplifiers (refer to spec sheet for precise specifications):

AMT 3200:

Class AB, frequency range 10-220 MHz (250 MHz with reduced power), max. power output > 1kW, input 1- 1.5 Vpp, max. pulse length 20 ms adjustable up to 100 msec, droop 3-5% over 10 msec, CW up to 150W. This or equivalent amplifiers are the standard X-range high power amplifiers for 500 and 600 MHz instruments.

Tube amplifier 4-165 MHz:

Class B-C, max. power > 1kW, tunable with exchangeable output boxes, output power switchable between 4 pre-selected levels between about 70W and full power within < 2 usec via grid voltage, required input power to exceed the threshold usually 8-16 W, max. pulse 500 msec at 400W, 100 msec at full power, droop typically < 1% over 100 msec 2 high power RF pentode tubes used either parallel or in push-pull mode (over 30 MHz) with an additional built-in grid driver transistor amplifier. These are the standard X-range amplifiers for instruments up to 400 MHz.

Tube amplifiers 200-360 MHz:

Tunable class B-C amplifiers covering 19F-3H for 200, 300 or 360 MHz instruments, max. power output > 1kW, power level switching and max. pulses as above, input power between 15 and 40W 2 high power RF pentode tubes used in push-pull mode, no grid driver. Optionally, these transmitters can also work in class AB mode.

Tube amplifiers 400, 500 and 600 MHz:

Class AB-B tube amplifiers with 1 high power RF triode tube and cavity resonator, tunable over the 19F/1H range. Output power controlled via input power level, max. output power 500-900W at 60 W input, max. pulse length as above, droop as given by the driver amplifier. N.B.: Since triode tubes are used here, there is no gain adjustment on these amplifiers which on all other tube amplifiers uses the second grid voltage.

B-LAX 1000 and B-LAH 1000 linear 1kW solid state amplifiers

These units are delivered from early 1996 on. They are driven by the ASU directly. In DSX instruments, only the 1kW output stage is available. For DMX instruments, internal relays, switched by the same bits as the power router relays, allow to set the output port for 300 W/1kW (B-LAX 1000) or 1000W/1kW (B-LAH 100). Those bits are wired from the TCU T1 to the transmitters directly, since no power router is required any more.

The pneumatic unit is located in the HP cabinet top part. It supplies all pneumatic operations for MAS probes. The maximum gas flow of this unit will, however, not support the operation of DOR probes. The main components of the PU are:

1. The microprocessor controller
2. Electrically controlled, pneumatically operated valves
3. 2 high precision pressure regulators for the range of 0-4 bar, driven by stepper motors
4. A spin rate counter
5. 2 keypads for manual operation
6. 2 LCD displays for pressure, spin rate, and parameter display

The microprocessor software is stored in a PROM (firmware). This software allows communication to the host computer via an RS 232 interface. It controls all functions of the unit. Operating in the LOCAL mode, the unit accepts the control operations given by the keypad. In the local MANUAL mode, pressures can be set by the up/down arrows on the smaller keypad. The firmware contains configurations for the currently used BRUKER MAS probes DB7, BL7 and BL4 which are required to provide safe maximum spin rates and appropriate spin up, spin down and regulation parameters in the automated mode.

The spin rate is monitored via an optical sensor. The spin rate counter module is connected to the probe with a 3 strand cable. Two strands provide a DC voltage for an LED located in the probe spin rate assembly. The infrared beam of this LED is guided up inside the probe via a two strand light fiber cable.

In older probes, the polished upper end of this light fiber cable points directly to the spinner bottom (DB probes), in newer probes, a lens at the upper end focuses the beam to the edge of the spinner bottom. This means that the positioning of this lens is very critical especially for 4 mm probes. The reflected optical signal is detected by the same lens and led down to a high gain photo transistor via the second strand of the light fiber cable. There the signal is detected and amplified. In the spin rate counter module, this signal is further amplified and counted with an integrative procedure measuring over several rotor periods to provide better sensitivity. The analogue signal is also converted into a rectangular signal to provide a trigger for rotor synchronized experiments.

The pneumatic section of the unit provides the following outputs:

- outputs for SB-MAS probes to tilt the stator vertical for eject and to the magic angle for measurement
- outputs for eject and insert, both regulated with needle valve adjustments
- an output for the probe frame cooling (frame flush) to maintain safe temperatures inside the probe, adjustable with a needle valve
- outputs for drive gas and bearing gas, the latter one switchable between 3 ports to support older style MAS heat exchangers with switchable loop lengths.

There is also a monitor input line which supervises the bearing pressure to sense an eventual rapid loss of bearing pressure. In such a case, the drive gas pressure is rapidly reduced to prevent probe and spinner damage.

Bearing and drive pressure is monitored with pressure sensors to provide a display of currently used pressures and to monitor safe ranges. Since the precision of these gauges is about 10 mbar, the indication is in steps of 10 mbar as well. Regulation of the spin rate is solely done via the measured spin rate. The adjustment of bearing and drive pressure is done by precision pressure regulators driven by stepper motors. These regulators are selected for the pressure range of 0-4 bars to provide best regulation precision in this range. This means, that the input pressure must be well above the maximum regulated pressure of 4 bars. With higher input pressure, better stability is achieved. The input pressure is prestabilized with a common pressure regulator. For safety, the unit also contains an additional submicro line filter. It must be pointed out that regulators working up to a higher pressure range would provide less stable spinning especially at slow speeds, and that regulation becomes also unstable at very low pressures and flow. Therefore, higher spin rates can only be achieved by optimizing the drive efficiency, and very slow speeds are achieved by artificially reducing the drive efficiency, for instance with fluteless spinner caps. It is needless to say that highest purity is required for the compressed gas in order to provide safe PU and probe operation.

Automatic mode operation of the unit activates probe dependent spin up and down algorithms and spin rate PID regulation. For safety, the maximum spin rates are not achievable in the automatic mode. The manual mode will allow higher pressure settings that deviate from the standard settings of the automation routine. For 7 mm BL probes, the bearing pressure is set according to the following formula:

$$\text{bearing pressure (mbar)} = 2 * \text{drive pressure} + 700 \text{ mbar} \leq 3000 \text{ mbar.}$$

For 4 mm, the formula is

$$\text{bearing pressure (mbar)} = 2 * \text{drive pressure} + 1700 \text{ mbar} \leq 3000 \text{ mbar.}$$

To avoid constant changes of the bearing pressure which would affect the drive gas regulation, bearing pressure changes are only executed if the spin rate changes by more than 100 Hz. For more details on the operation of the PU, please refer to the section II.6, Operation of the MAS Pneumatic Unit.

Four Phase Modulator (4-PM)

1.4

The 4-phase modulator is physically located in the main rack, but is operated from the HPCU via HPCU keypad or via NMR-software¹. Its purpose is to allow very fast phase shifts by 90 degrees. Since there is fast phase shifting over an arbitrary phase angle available using the DDS phase shifter, the necessity of this additional phase shifting is not obvious. Without going too much into hardware details, the explanation is the following. The DDS (Direct Digital Synthesizer) is located in every FCU. It generates digitally a 3-4 MHz signal which can be changed in phase (resolution about 0.02 degrees) and frequency (resolution about 1 millihertz) within 50 nsec. This frequency is used as a base frequency in the generation of the NMR frequency by feeding it into the synthesizer or, in the case of standard proton frequency generation into the so called triple mixer that generates the proton frequency.

1. If there is no HPCU present

Since RF filters are present in these units, the phase (or frequency) shift is delayed by about 2 usec when passing through the synthesizer or about 0.5 usec when passing through the triple mixer. This delay is compensated by software insofar as the phase shift is initiated some time prior to the pulse. For very short delays between pulses or back to back pulses, this may still be insufficient. This is where the 4-phase modulator is advantageous since its phase shift time is shorter than 100 nsec. To achieve this, the phase shift is executed at a late point in the RF generation where no noticeable propagation delays occur. As explained in the section about the SE451, there are phase shifters located in the 440 MHz pathways of every transmitter board and additionally in the reference frequency generator for the receiver. There is only one additional mixing step afterwards with fairly wide filters so no delay is introduced. These phase shifters generate internally two 440 MHz paths which are 90 degrees out of phase and can be mixed together again with proportions depending on 2 external DC voltages.

These voltages are generated in the 4-phase modulator board. The amplitude of these voltages is controlled from the HPCU and is set via the 4-phase modulator adjustments described earlier in the HPCU section. 4 possible combinations of 2 DC voltages are adjusted setting the amplitude as well as the phase. Any of these combinations is set by means of the PH1 and PH2 logic level DC pulse from every FCU (with 2 pulses, $2^2=4$ combinations can be set). The reference phase can be set over a range of more than 360 degrees by adjusting the DC control voltages at the phase shifter from a sine and a cosine waveform stored in the 4-phase modulator board. Refer to the software section for information about the programming of phase shifts in a pulse sequence. Two things must be kept in mind:

1. Due to the structure of TCU and FCU, it takes 5 instruction steps to transfer the phase shift information from the TCU into the FCU. This means that the actual phase shift is executed 250 ns after the RF gate pulse has been opened. This must be compensated together with the actual phase shifting time in the edson PHASPR parameter set.
2. FCU's of ECL 04 or earlier are only operated properly with UXNMR versions 941001.n or earlier. In that case, the phase of DDS and 4-PM are mutually interactive which means that setting a 4-PM phase will reset the DDS phase to 0 and vice versa.

With FCU's of ECL 06 or later, XWIN-NMR software must be used, and both phase shifting possibilities are independent from one another. In this case, 4-PM phase shifts are added to any previously executed DDS phase shift. This very useful, if parts of a pulse sequence programmed for the 4-PM must be simultaneously phase shifted, for instance when pulse trains need to be shifted through a TPPI phase program simultaneously. Since the DDS phase shift works on the synthesizer frequency, and the 4-PM works on the 440 MHz IF, the phase shifts are independent and the total phase will be the sum of both phase shifts.

High Power Preamplifiers, HPHPPr

1.5

The preamplifier unit is located next to the magnet since the leads from the probe to the preamplifier should be as short as possible for better signal to noise. The cover module contains the microprocessor unit for communication to the CCU via RS 232 and supervision of all preamps, the RF routing module, the blanking circuit and an additional RF amplifier to amplify weak NMR signals. The display module in the cover indicates the preamps activated by the current parameter set. The tune/match display is used for probe tuning as described in the standard set-up section.

For DSX (solids only) instruments, there are 2 preamplifier units, for DMX instruments there are additional preamplifiers for the lock and proton as well as X-nuclei observation. The RF preamplifiers are very similar in all units, however the multiplexing and filtering devices are quite different. Up to 5 preamplifiers can be served from the cover module. When the spectrometer is configured, the microprocessor detects and recognizes all available preamplifier units and reports this to the configuration software of UXMNMR. It also finds the location of every module so it can be properly addressed. Every preamplifier unit must have the appropriate hardware code. The location of units in the stack is arbitrary, however the RF wiring must correspond to the preamplifier code. The leads going to the preamplifier unit are the following:

DC cables:

- RS 232 cable to CCU RS 232 interface (cannon connector). This cable carries the digital communication.
- Round burred cable to main rack wiring distributor. This cable carries the blanking pulses and another pulse that allows to rapidly switch between pre-selected preamps, also the required DC voltages.

RF cables:

- BNC cable from the SE-451 tuning output. It carries the swept RF NMR frequency at a level of about 10-20 mVpp. for probe tuning.
- BNC cable to the BSMS lock receiver (DMX or DSX with lock only). It carries the preamplified lock signal.
- BNC cable (thick) to SE-451 RF in. It carries the preamplified NMR signal from the selected preamplifier to the receiver.
- Transmitter cables, usually thick doubly shielded coax cables from the RF amplifier to the corresponding preamplifier back side (N-connectors)
- Probe cables, thick or thin coaxial cables from every preamplifier front side to the appropriate probe RF channel (N-connector at preamp side, BNC connector or N-connector (depending on probe) at probe side.

High resolution and high power preamplifiers (DMX only)

The rear connections of the HPPR unit need never be changed except in two cases:

- a. Changeover from deuterium lock to deuterium observation in high resolution mode.
- b. Changeover from observation via F1 channel to observation via F3 channel, if a three channel SE-451 and a 3rd transmitter are available, if only 1X-HPPr is available.

Changeovers in the transmitter setup (between high resolution and highpower mode) are executed by the power router and require no manual interaction.

Differences between high resolution and high power preamplifiers.

High power preamps differ in 3 respects from high resolution pre-amplifiers:

1. The requirements for filtering are less since usually no lock is used. This means that a lock band stop filter in the X-nucleus preamp is not necessary. This makes, unlike the high resolution X-broadband preamplifier, observation of 2H possible on the high power X-broadband preamplifier.

2. Pulse powers are substantially higher, pulses of very low power levels (like for presaturation) are never used, high power pulses can be rather long. Therefore, the multiplexer circuit is made up with passive diodes instead of actively switched pin diodes. This means that pulse RF voltages below about 0.7 V are clipped and not transmitted. On the other hand, pulse powers of over 1 kW (high resolution: 400W for X- and 100 W for 1H/19F observation) can easily be handled over up to 100 msec.
3. The deadtime must be shorter. This means that narrowbanded filters must not be used. These filters are used in high resolution preamplifiers to filter out lock and decoupling frequency to suppress RF artifacts. This allows to use the same high power preamplifier for 1H/19F/ 3H observation where in high resolution separate preamplifiers must be used. In turn, it also means that external filtering may be necessary for decoupling experiments in high power mode.

FADC BC-133 and Filter Board FT-LP 4M

1.6

For wideline experiments, fast signal sampling is required since the signal may have a very short T₂. For such experiments, it is some-times difficult to discriminate between the free induction decay and deadtime artifacts. Therefore the baseline must be well defined, which means in practice that the sampling window should be about 5 times the spread of the NMR line. Since line widths of 500 kHz and more are observable if the deadtime is sufficiently short, the sampling rate should be at least as short as 200 ns (2.5 MHz). In order to minimize sampling artifacts, it is advantageous to sample at even higher rates to gain dynamic range (over sampling). The fast ADC used in DMX/DSX instruments allows sampling rates down to 50ns with simultaneous quadrature detection (10 MHz). In single detection, 20 MHz window scan can be digitized. However, the software allows only 100 ns currently.

Since such fast sampling rates require also fast storage of the acquired data, fast memory and a fast data bus are required. This is why the FADC is connected directly to the RCU (Receiver Control Unit) that holds the acquisition memory. Since the accumulation of consecutive scans is also done on the RCU, there is 2 different types of memory located on the RCU: The fast memory (SRAM) of 256 Kbytes accepts the data from the digitizers and after the scan hands them over to the much larger acquisition memory (DRAM) of 1 M word (optionally 8M words) of 32 bits. Out of this memory, the FID display is updated.

Audio filters in DMX/DSX instruments.

Signals and noise outside the desired spectral range must be filtered out for cleaner spectra and less noise. This is achieved by so-called audio filters since they work on the audio signal that is obtained by mixing the NMR frequency down with the carrier frequency. Filtering can be achieved with hardware or software filters. Usually, emphasis is given to an approximately rectangular filter function in order to cut off as sharply as possible at both sides of the spectral window with little amplitude distortion inside the spectral window. Hardware filters can approximate a rectangular filter function only rather coarsely, so usually the filter had to be set 20% wider than the spectral widths. Typical filter parameters are the shape of the filter function, dead time and phase distortion.

Approximating the desired square shape closely means longer deadtime and more phase distortion, so a compromise had to be made with the filter setting slightly larger and a more or less trapezoidal filter function.

Digital filtering as used in DMX/DSX instruments is however far more efficient. Digital filtering can easily be understood when compared to Fourier Transformation which may be considered as a very efficient digital filter. Setting the spectral width close to the instruments bandwidth means to utilize the shortest possible deadtime of the instrument and the smallest possible phase distortion within the spectral range of interest which (with quad-detection) will occupy a small area in the middle of the spectral width. Of course, in order to digitize the FID properly, the total acquisition time must be sufficiently long which means that many more data points must be acquired compared to a matched spectral width.

In that case, the FID is over sampled, because more data points are sampled than necessary. Opening up the spectral width usually means that more noise is sampled and one might think that the signal to noise ratio will be worse. This is not so, since the definitely bigger noise is distributed over more points if a sufficiently large data set is acquired, and therefore the signal to noise ratio is even better since the audio filters no longer fold in noise from outside the spectral width. If noise is folded in due to the instruments limited bandwidth, it is folded into areas where no signals occur. If one cuts out the desired spectral range after Fourier transformation, a spectrum with better baseline and somewhat better signal to noise is achieved. Cutting out this range is equivalent to a absolutely square filter function, without the drawbacks of a much less efficient hardware filter. Essentially the same is done in digital filtering: The FID is over sampled at the fastest possible sampling rate, and consecutive data points are combined into 1 data point by a mathematical decimation procedure which after Fourier Transformation directly yields a spectrum covering the desired range. Of course, this filters steepness is given by the number of data points that are combined into one. Not only is the baseline flatter given by better deadtime and less phase distortion, also the dynamic range is increased. This can be understood considering that small signals ride on a higher noise level and are therefore more easily digitized. Due to the high steepness of a digital filter, undesired signals can be very efficiently removed, even if the desired signal is small compared to the signal to be filtered out.

One thing must be kept in mind, however. Signals that are folded in because they are outside the digitized window (Nyquist) cannot be discriminated from wanted signals by the digital filter and are therefore not filtered out. This is why in addition to the digital filter so-called anti-aliasing filters are required which set the instrument bandwidth slightly larger than the sampling window given by the digitizes speed. If the instrument is equipped with a HRD-16 digitizer, a full range of audio filters is available. With SADC or HADC, 3 audio filters of 150, 75 and 20 kHz are used, filtering down to narrower bandwidths is solely possible with digital filter. Since the fast ADC(FADC) is wired to the broadband receiver channel of the SE-451, these filters are not accessible with SADC and HADC slow digitizers. An additional analogue filter board is therefore required, the FTLP-4M.

For spectral widths below 73 kHz, digital filters are in that case possible also for the fast ADC. This maximum digitally filtered spectral range is given by the speed of the digital signal processor (DSP) that executes the digital filter operation „on the fly“, that means during the dwell time. This DSP is located on the RCU board. The advantage of this procedure is that the huge amount of data of an over sampled FID need never be stored as such but only in the decimated and filtered format. The disadvantage is, that at fast sampling rates digital filtering is not available in the same manner. Therefore, for standard wideline acquisitions, a set of audio filters is required which are 4-pole butterworth filters located in the FTLP-4M board. The available filters are 250, 500 kHz and 1,2 MHz. Higher filter-widths activate a bypass without any filtering. In addition to the filters, the FTLP-4M board also serves as a power supply for the FADC board, and as an additional audio

amplifier for small signals that may not adequately use the 12 bit dynamic range of the FADC.

The board has inputs for both broad band audio channels, matched to the 50 Ohm impedance of the SE-451 broadband receiver channel. There are four outputs, two of which with +/-5 V signal level and 1 MOhm impedance which can be, but usually are not wired to the „slow“ ADC, and two outputs with 50 Ohm impedance and +/- 0.5 - +/- 2.5 V (adjustable) signal level that is wired to the FADC signal input.

High Power Probes

1.7

The NMR probe is the central component of the NMR experiment. Therefore, the performance of the probe determines largely the quality of the experiment. As will be shown later, the construction of the probe always means making a compromise between different contradictory requirements. This means, that the performance of a probe is never good when it is used in a mode that it was not designed for.

Design criteria for probes

1.7.1

The main criteria for probe design are:

- sensitivity should be as high as possible
- deadtime should be as short as possible
- pulse lengths should be as short as possible
- bandwidth should be as high as possible
- H1 homogeneity should be as good as possible
- power handling should be as good as possible
- tuning range should be as wide as possible
- H0 homogeneity should be as good as possible
- temperature range should be as wide as possible
- background signals should not exist

The first seven criteria deal mostly with the RF design of a probe, the 8th-10th deal with the materials used in the mechanical probe construction.

Probe parameters

1.7.2

Probe sensitivity

When one considers the factors that govern probe sensitivity, it becomes clear that the first 4 parameters, sensitivity, dead time, pulse lengths or RF field, and bandwidth are largely interdependent, and a gain in one parameter means a loss in other parameters. A probe is tuned for a certain resonance frequency following Thompsons formula which calculates the resonance frequency from inductance, L and capacitance, C as $\nu = 1/2\pi \cdot \sqrt{L \cdot C}$ (Hz). resonance frequency F_0 [MHz] = $5035.2 \cdot 10^6 / \sqrt{L \cdot C}$ with L in nH and C in pF

Since the NMR signal is a rotating magnetization vector, the signal originates only in the inductive part of the resonance circuit where it generates an oscillating current which is detected and amplified in the preamplifier. The detected signal will increase

- a. With the size of the rotating magnetization vector generated
- b. With the efficiency of detection of the induced current.

The a is given by the number of excited spins, their magnetic moment and the x/y magnetization generated by the pulse. This need not be dealt with in this context since it is given by the nucleus, sample concentration and flip angle of the pulse except for the fact that the sample volume should be as large as possible.

The sensitivity S of a probe is given by the filling factor of the receiving coil and the Q of the resonance circuit.

Filling factor F

A high filling factor means that the detection coil should be as large as possible, as much of the inductance as possible should be filled with sample, and the sample should be as close to the coil wire as possible, since the induced signal decreases with r^6 . The size of the coil is restricted by its inductance, since according to the Thompson formula, the inductance of a coil is restricted by the desired resonance frequency and the smallest capacitance that can be achieved. Usually, the adjustment of the resonance frequency (tuning) is done by variation of a variable capacitor, which has a minimum capacitance (in the order of 1-7 pF). Also, the probe will always have so called stray capacitance from any part of the RF circuit to ground, which, depending on the construction of the probe will be between 2 and 10 pF.

From these arguments it can be said that the biggest coil that can be used is given by the desired resonance frequency and the sum of minimum tuning capacitance plus stray capacitance. It is also obvious that a larger coil will not improve the signal proportionally to the coil volume, since the inner part of the sample will be further away from the coil. Also, part of the inductance will always be in the leads to the coil where no signal (except background signal) will be generated. Also, it becomes clear that given mechanical requirements (sample spinning, angle variation, insulation against extreme temperatures) have a large influence on what can be achieved in terms of RF performance of a probe. The ideal case would be a coil with all tuning elements directly attached to it in a vacuum environment, which is of course far from real especially in small bore probes. Ways to optimize the filling factor are to use thin coil support tubes or no tube at all (self supporting coils), to keep the leads to the coil as short as possible, and to design the RF circuit in such a way that little inductance is generated in filters (especially in multiply tuned circuits).

Circuit quality factor Q

The quality factor of a circuit is given by two types of inevitable losses that reduce the induced current oscillating at the NMR frequency. One comes from ohmic resistance along the leads and the coil, the other from dielectric losses (or less than infinite ohmic resistance) along the capacitance's. The quality factor Q will determine a number of relevant probe parameters listed below

Table 1.2. Probe Parameters for Quality Factor Q

Probe parameter	Q-dependence	requirement
pulse length	$1/\sqrt{Q}$	short
deadtime	Q	short
max. RF voltage in the probe	Q	low
bandwidth	$1/Q$	high
sensitivity	\sqrt{Q}	high

From this table it becomes obvious that every probe must be a compromise that is most suitable for the experiment. In general, all high power probes that are used for line narrowing experiments like MAS and high power heteronuclear decoupling are designed for high Q with correspondingly long dead times and narrow bandwidth, whereas CRAMPS probes and wideline probes are optimized for wide bandwidth and short deadtime. ^1H and ^{19}F wideline probes have high Q because the deadtime and bandwidth is usually not a problem at these high frequencies, since the deadtime is inversely related to the frequency. Also, the line widths involved are usually not very big. If such a probe is to be used for homonuclear dipolar decoupling (multipulse decoupling), these probes should be lowered in Q. In wideline probes, where line widths in excess of 100 kHz are observed, the bandwidth and deadtime are more important than sensitivity, so the probes are usually set for low Q. If line widths are below 100 kHz, the probe can be used in a high Q mode for better sensitivity. The disadvantage of low Q probes is that higher power is required to achieve short pulses, so lowering the Q for broader lines is limited by the less efficient excitation due to longer pulses. In probe design, high quality factors can be achieved by thick leads made from good conductors (usually silver wires or silver plated wires, where the silver plating must be substantially thicker than the penetration depth of the RF at the highest frequency used) and by capacitors which have dielectric's with low dielectric losses at the desired frequency and very high resistance. Usually, vacuum or gas filled variable capacitors are used together with high Q ceramic or quartz capacitors. This is also important with respect to the maximum pulse voltage that a probe can handle. Another design principle leading to higher Q is the symmetric construction of an RF circuit which distributes the tuning capacitance roughly equally over both ends of the coil. This generates the current maximum in the center of the coil rather than on one end of the coil.

H1 homogeneity

H1 homogeneity describes the uniformity of the RF field over the coil volume. For single pulse excitation, RF homogeneity is not an important parameter. For experiments where many subsequent pulses are executed, H1 homogeneity can become a very important parameter in terms of performance, especially when many π pulses are used for refocusing, since spins that do not experience a full $\pi/2$ or π pulse will eventually be lost for detection or degrade the quality of the experiment. Almost all high power probes use solenoid coils which have substantially better H1 homogeneity than the saddle- or Helmholtz coils used in high resolution probes.

The best H1 homogeneity can be achieved with cavity resonators, which, however, are only efficient for large volumes or frequencies over 400 MHz. In solenoid coils, the H1 homogeneity is largely dependent on the relation between the length and the diameter, the spacing between the turns, and the surface of the coil wire. Since the length of a coil is limited by the maximum inductance given by the desired resonance frequency at a given diameter or by the available space (inside a MAS stator), it is always easier to make a long coil at a smaller diameter.

For good H1 homogeneity, a coil should be minimum 1.5 times longer than its diameter. In such a coil, the sample can be as long as the coil for standard experiments, and as long as thick for multiple pulse experiments. However, this is not the only parameter governing H1 homogeneity.

The pitch of a coil and the coil shape are also important in a second and third approximation. In general, the pitch of a coil should be as low as possible making the spacing between the turns small. This leads to higher inductance compared to a stretched coil and to larger capacitive losses between the individual turns of a coil, so the best compromise must be found. The shape of the coil wire should usually be not round but flattened which also provides a slightly better filling factor, so it is always applied if spatial restrictions allow it. If there is ample space and the Q need not be very high, the coil can also be lengthened by winding coils with 2 parallel wires which leads to long coils with small pitch and still tunable inductance since $1/L = 1/L_1 + 1/L_2$, so 2 identical coils wound in parallel will yield half the inductance of a single coil at twice the length, at the cost of Q.

Power handling capability

As pointed out above, the pulse widths should be short which requires either high transmitter power or high Q RF designs. Especially in low Q probes with nuclei of low gyromagnetic ratios, the available transmitter power sets a limit to the achievable pulse lengths. There is however another limit in the voltage that a probe can take. Within a probe matched to an impedance of 50 Ohms, the maximum voltage developed inside a probe can be calculated from

$$U(\text{max.}) = U(\text{input}) \cdot Q/50$$

For 1 kW of pulse power, the input voltage is roughly 600V pp (peak to peak). This means a maximum voltage of about 600 for a Q of 50, but about 3 kV for a Q of 250. For all high power probes, capacitors with a rating of 3 kV up to 15 kV are used, with 5 kV minimum at the points of highest voltage which of course is only developed in some „hot spots“ of the probe, usually near the coil. However, there are additional precautions to meet with respect to voltages between conducting parts and the probe body. Points of very different electric potential should not be placed closely spaced, sharp edges must be avoided, and the atmosphere in between must be dry, must not contain gases with low ionization energy or high ionic conductivity (helium). Also, all surfaces at hot spots must be clean of oil, humidity, organic matter or sweat (never touch those spots!).

It should be kept in mind, that increasing the Q also increases the voltage developed and therefore the shortest pulse may be limited by arcing of the probe rather than the available power. If probe arcing occurs, one should first clean the probe and remove any burnt material before proceeding. It should also be kept in mind that long high power pulses will generate heating inside the probe which may push parts of the probe closer to the ionization voltage or detune the probe in such a way that arcing occurs.

Deadtime and acoustic ringing

In pulsed NMR, the signal is generated with a short pulse. The energy taken up by the spins is only a small fraction of the total pulse energy. The spins will store this energy for a time given by T1, however, it is only observable over a time span given by T2. The RF circuit will however also store the pulse energy and release it after the pulse during a time which is called deadtime, since signal observation is not possible then. As pointed out above, the deadtime of a probe is related to the probe Q.

$$t_{\text{dead}} = 20 \cdot Q / 2\pi \cdot F_0$$

so with a Q of 100, the deadtime will be 3.2 usec at 100 MHz, and 32 usec at 10 MHz.

However, this refers only to the electronic deadtime of a probe. This deadtime is measured as the time when the deadtime signal voltage has decayed to 1/e of the initial voltage. For NMR applications, this definition is not very helpful since even there it may be much larger than the detected signal. Here the definition is usually the time when the deadtime signal has decayed below the noise level. It is obvious, that the deadtime of a probe must be substantially shorter than the sample T2, which at high frequencies and long T2s is usually no problem. For short T2s as in wideline spectroscopy, this is however rarely the case. Reducing the Q of a probe and using echo techniques will work as long as the NMR signal at the start of the acquisition is at least as large as the residual deadtime signal. In such cases, experimental tricks to cancel the deadtime signal with consecutive scans will work. If the deadtime signal is much larger than the NMR signal, it will not be canceled sufficiently well and it will add just like the desired signal with signal averaging. The electronic deadtime of a probe will strictly be determined by the probe Q and bandwidth. For wide lines and short T2s, the bandwidth must be wide and the deadtime must be short, so the Q must be low and the sensitivity loss must be accepted.

Unfortunately, the electronic deadtime of the probe is not the only deadtime that can be observed, especially at low frequencies. Apart from possible dead times in other RF devices like filters or preamplifiers and receivers (which usually have higher bandwidths than the probe and therefore shorter dead times), there may also be acoustic ringing, and, in some samples with piezoelectric properties, there may piezoelectric ringing. These phenomena can generate signals much larger than the true NMR signal with decay times of many microseconds up to milliseconds. In the case of piezoelectric ringing, the pulsed electric field causes constriction of the sample which is released after the pulse, inducing a signal in the NMR coil. In the case of acoustic ringing, the current flowing in the coil causes a magnetic field which interacts with the static magnetic field and generates eddy currents and/or mechanical vibrations which can decay slowly in highly conductive metals, causing the acoustic ringing signal. Acoustic ringing is only seen with the probe in the magnetic field, whereas electronic deadtime shows without the magnetic field.

The size of the signal depends on the probe construction and on the strength of the magnetic field. The same frequency/probe combination will have stronger ringing in a higher field magnet, however, with higher frequencies in the same magnetic field, the ringing signal is reduced. With NMR coils made of massive silver wire not mounted on a rigid support, acoustic ringing with decay times of 100 - 200 usec can be seen up to NMR frequencies of 50 MHz. This is why low frequency coils for wideline probes usually consist of thin wire coils glued to a rigid support despite the inherently low Q of such coils. It is reasonable to assume that at frequencies below 50 MHz the main reason for probe deadtime is not the high Q but acoustic ringing, which can be easily checked by accumulating 1000-10000

scans on an empty probe inside and outside the magnet. The difference in dead-time signal is acoustic ringing. Such ringing signals may be very difficult to get rid of, usually by changes in the coil design, and they may show up again with slight changes in the observe frequency or changes in temperature.

Tuning range

Obviously it is nice to be able to observe many different nuclei with only one probe. However, there are limits to the tuning range. The limit to the high frequency edge is set by the minimum tuning capacitance and the stray capacitance, at a given inductance. To squeeze the tuning frequency up, it is possible to either replace the coil with a smaller one, or by switching in a parallel coil which reduces the total inductance. However, this coil is usually not filled with sample, so the effective filling factor and the signal to noise is reduced.

To enlarge the tuning range down to lower frequencies, one may similarly fit a coil with higher inductance, or one may enlarge the tuning capacitance with a parallel capacitor. In the wideline probe, the coils are easily exchangeable, so enlargement of the tuning range just requires a new coil. In other probes, exchange of a coil is not so easy, and in the case of doubly or triply tuned probes this is impossible since all the other frequencies would be shifted simultaneously, and built in filters would be affected. In those cases, changes in capacitance's are the only means. There are limits, of course, since the stray capacitance can never be substantially reduced, limiting the tuning range to higher frequencies, and adding capacitance to shift to lower frequencies may require very large capacitors in parallel, which reduces the effective adjustment range of the tuning capacitor.

Tuning over a wide range will in most cases provide less sensitivity than dedicated probes, since best sensitivity is usually achieved with the highest possible inductance in the receiving coil, and smallest possible capacitance. This why many probes where the coils cannot be changed, and the tuning range is achieved with large tuning capacitors perform best at the high end of the tuning range.

Multiple tuning

For double and triple resonance experiments, multiple tuning of a probe is required. This can be done with separate NMR coils as in high resolution probes, where the decoupling coil is a separate larger coil around the receiving coil. In solids probes, all resonance frequencies are tuned to the same coil. This requires separate sets of tuning elements for every channel, and filter elements to isolate every channel from the other channels.

Multiple tuning will always degrade the performance of a probe compared to a singly tuned probe. This degradation is small if the 2 or 3 frequencies are very far apart, and it becomes substantial if the frequencies move closer together. Tuning a deuterium lock frequency to a proton observe circuit will deteriorate the proton channel by about 10%. Tuning N-15 to a C-13 channel will cost about 50% on every channel.

It is usually possible to improve one channel at the cost of the other, so N-15 and C-13 tuning can be set such that the loss is 60% on the C-13 and only 40% on the N-15 channel. One must be aware that the losses can be substantial for even closer frequencies. The important parameter is not the spacing in MHz but the relative spacing as a frequency factor, so the losses are similar for a 300 and 400 MHz instrument.

H0 homogeneity

With solids probes, H0 homogeneity is usually not a high priority design problem, since the lines are usually intrinsically wide compared to liquid samples. However, there may be cases where good shims are also required with solids probes. This is obviously true for liquid samples run in solids probes, when the solids probe pulse performance is required to excite and detect large chemical shift ranges. It is also required for measurement under MAS conditions, where very narrow lines can be achieved.

Provided that the sample is placed in the magnet center and its dimensions do not exceed the homogeneous volume of the magnet, the resolution and line shape can be severely reduced in the following cases:

- a. Large magnetic gradients are generated by magnetic parts in the probe
- b. Substantial gradients are produced by materials near the coil or in the coil with non zero magnetic susceptibility
- c. The gradients are not removed by sample spinning
- d. The shim system is not optimized for the coil geometry used in the probe

All high power probes are tested for magnetic impurities, and high quality components are used near the NMR coil. Ferromagnetic materials are usually no more disturbing than the non zero magnetic susceptibility for other materials near the coil. At high magnetic fields, the non-zero magnetic susceptibility of the coil, the sample tube, and the sample generate the strongest gradients. If sample spinning is not used, these gradients are usually extremely difficult to shim out since the shim gradients are optimized for a vertical sample geometry and, in addition, a wide bore shim system cannot generate high enough shim gradients. Therefore, the achievable resolution is mostly given by the coil, the sample and the sample container. If the resolution in a standard high power probe is not adequate for a special type of measurements, the following steps can be taken:

1. Order a special coil for this probe which is made from susceptibility compensated wire
2. If possible, shape the sample into a spherical shape using a spherical sample tube (WILMAD) and make sure that the sample volume is evenly filled with no air bubbles.

Background signals

The probe must be constructed from suitable materials, usually there is different polymers, ceramics, and metals. Materials which contain sensitive NMR nuclei give rise to big background signals on those nuclei if they are located in areas of high RF fields close to the homogeneous region of the NMR magnet, usually close to the coil and leads to the coil. Solids probes are designed for minimum background on the relevant nuclei wherever this is possible. However, especially for protons, fluorine, and some rarely observed nuclei, there will be a background in most cases. Proton background comes from adsorbed or included water on ceramic surfaces or in pores, or from polymer materials used in probe construction. Fluorine background comes from Teflon or Kel-F used in probe construction. In MAS probes, a strong boron background comes from the boron nitride used for the MAS stators. All probes with silver coated copper wire coils will have a large ^{63}Cu background (with Knight shift) from the copper metal. Please refer to the section on available probes for information on background signals in solids probes.

Filter requirements

For single resonance experiments, there is usually no need for any additional filtering. For double and triple resonance experiments however, additional filters are usually required. These filters prevent that RF from additional channels is picked up in the observe channel, which would deteriorate the signal-to-noise or generate spikes in the spectrum. Multiple resonance probes have built in filters to separate the channels, however such filters are usually only one filter stage and provide a channel insulation of about 25-35 dB, which is sometimes not sufficient, especially if linear broadband amplifiers are used on the additional channels. For proton or fluorine decoupling experiments, a bandpass or highpass filter in the decoupling line to the probe is usually enough. For triple resonance experiments, every X channel should have selective pass/reject filters matched to the combination of X/Y nuclei.

When linear broadband transmitters are used (B-LAX 300), there is one more argument for the use of such filters: If simultaneous pulsing on both channels is required (REDOR experiments), the pulse from one channel may activate the mismatch protection on the other channel and suppress the pulse from this transmitter. Tube transmitters have no problem there because they are very tolerant with respect to reflected power. If suitable filters are not at hand, the pulses can in most cases be programmed one after the other so that problem is avoided.

Are large sample volumes always desirable?

Many probes exist with different sample sizes, and one is always inclined to use the largest volume to save measurement time, since the NMR experiment is not a very sensitive one. However, there are considerations that suggest smaller sample sizes. It must be kept in mind that larger coils will have higher ohmic resistance and hence lower Q. Furthermore, a larger coil will lead to higher stray capacitance to the environment and therefore the increase of inductance will not be quite as high as expected. In general, the gain in signal to noise in going to larger sample volumes will never correspond to the increase in amount of sample. Comparing, for instance, 5mm high resolution probes to 10 and 20 mm probes, the sample requirement goes from 0.5 ml to 2 ml to 10 ml, but the S/N increases only by about 1:3:7. This is rather similar to solids probes.

There is another problem related to large coils, which is rather important for solids measurements where short pulses are required. This is that for larger coils of otherwise the same parameters, much higher power levels are required for the same pulse lengths. If a low Q 5 mm coil of a wideband probe has a 2 usec 90 degree pulse length at 1 kW of power, a 10 mm coil with roughly 4 fold volume will require over 4 kW to achieve the same RF field. In general, at a given power of 1 kW (which is what such a probe will easily take), a 10 mm coil has more than 2 times longer pulses than a 5 mm coil. However, in practice, a coil diameter twice as big means that the coil length may have to be shorter or of higher pitch in order to remain at the same inductance. Then the increase in volume may not be as high as desired.

Furthermore, smaller diameter coils have better H1 homogeneity in most cases, so experiments with long pulse trains, especially with many pi pulses, will work better in smaller coils. To make a long story short, smaller coil diameters should be preferred if the signal is big enough. For small amounts of sample, it is obvious from the filling factor, that smaller coils will give substantially better signal/noise than larger coils with coil volumes exceeding the sample volume.

Temperature range

The temperature range of a probe is limited by 3 factors:

- a. The range in which a probe can work reliably without major risk of probe damage or malfunction
- b. The maximum or minimum temperature that the magnet and the room temperature shim system may experience during variable temperature runs, due to thermal exchange with the probe.
- c. The maximum heating or cooling that can be achieved with the B-VT 2000/3000 heater or the cooling device. Usually, the probe is exposed to the most extreme temperatures and therefore is the limiting factor.

Both „b“ and „c“ become important when extreme temperatures are set in probes with insufficient insulation or a large throughput of cooling or heating gas. In those cases, additional precautions should be taken to protect magnet and shim tube as described under II, standard setup procedures.

Short description of high power probes for DMX/DSX instruments

1.7.3

(All probes for wide bore magnets, room temperature bore ≥ 89 mm, shim tube inner diameter 72 mm, unless specified otherwise)

Stationary probes

These probes are all designed for observation without spinning, using horizontal solenoid coils.

1H wideline probes:

Tuning range 1H/19F, large background on 19F from Teflon, small background on protons, that can be minimized by washing the ceramic sample compartment in absolute alcohol.

Subsequently, the probe must be heated up to 130 C for 10 min. using the standard VT control. The Q is moderately high, the coils can be easily exchanged. 5 mm, 7.5 mm, and 10 mm coils are available, 5 mm is recommended. For multiple pulse experiments, the Q can be reduced if desired.

19F wideline probes:

Tuning range 19F/1H, large background on protons from polyethylene, small 19F background, not removable.

Otherwise, this probe is identical to the proton wideline probe. On both probes, the usable temperature range is -150 up to +250 C. On both probes, the RF circuitry is largely identical to CRAMPS-MAS probes.

CP probe:

This probe is designed for X-observe, 1H/19F decoupling experiments with or without cross polarization. The coil is a 5mm, 7.5 mm or 10 mm solenoid coil (5mm recommended, 10mm only in special cases). The probe circuit is largely identical to CP/MAS probes, the sample compartment is identical to 1H/19F wideline probes. This probe can be used for wideline experiments of X-nuclei with decoupling, if the lines are not wider than approx. 100 kHz.

Special coils are available with lower Q for wide lines. Note that decoupling also becomes less efficient or may even be impossible with such coils. Background signals are present for 23 Na, 27 Al, 1H, 19F, 29 Si, 13C

(small), ⁶³Cu (large). Due to the horizontal coil arrangement, the probe must be removed for sample change.

Since the mechanical design of all previously described probes is similar, the VT range is -150 to +250 C for all probes. The insulation in these probes is quite good, so the only safety precautions for probe, shim tube and magnet to be taken are the use of the probe frame flush, shim tube cooling, and the additional glass exhaust tube for temperatures below -120C and above 200 C.

X-range wideline probe:

This probe is designed for wideline experiments on nuclei in the range up to P-31. For higher frequencies, special probes may be available on request. This probe can be equipped with Teflon sample compartment (temp. range from -150C up to 250 C) or ceramic sample compartment (up to 400 C). The coils are exchangeable. 5 mm up to 10 mm coils are available. 2 coils are standard, covering the range of most important nuclei. Special coils are available on request.

Decoupling at moderate power levels can be added on request. The Q depends on the coil and can be varied over the range of 30-185 with exchangeable inserts which also provide symmetric tuning for the most important nuclei. Background signals (small) are visible for ²⁷Al, ²³Na, ¹³C (large for Teflon sample compartment), ⁷Li, ⁶³Cu (large).

Additional safety precautions should be taken as described above for stationary ¹H wideline and CP probes.

X-range wideline goniometer probe:

This probe is identical to the standard X-range wideline probe. A goniometer single angle adjustment (optionally with motor drive) is fitted in a Vespel housing (large C-13 background). The temperature range is reduced to -120/+150C.

Cryogenic X-range wideline probe:

This probe is designed for the use in a cryostat mounted inside the wide bore shim tube. Low temperatures down to approx. 5 K are achieved by pumping liquid helium through the probe (with liquid nitrogen, temperatures down to -194 C are obtained). 5mm solenoid coils are used, other diameters on request. For sample change, the probe must be warmed up and removed. The tuning frequency is fixed, the range is about 1 octave. Coils can be changed to tune to other nuclei. X-and proton ranges are available.

Probes with fast sample spinning

Currently, all fast spinning probes spin the sample under the magic angle (Magic Angle Spinning, MAS) or under 2 angles simultaneously (Double Angle Rotation, DOR).

CP-MAS probes:

For MAS, many different tuning ranges are available, usually covering the range from N-15 to ¹³C, from C-13 to P-31, or from N-15 to P-31. The decoupling channel can be ¹H or ¹⁹F or ¹⁹F-¹H. Special tuning frequencies are available on request. Triple tuning is achieved with additional removable traps. There is a dedicated trap for every X/Y combination. Without trap, the probe can be used as standard double resonance probe. The spinner sizes

are 4, 7 and 10 mm (10 mm up to 300 MHz). Several different stator designs are used requiring different spinner caps for drive.

The DB type probes have caps slightly larger in diameter than the spinner, BL type probes have caps with the same diameter as the spinners. Stators are either made from boron nitride or from magnesium oxide. The first type is limited in temperature range from -120 to +150C, the MgO stator goes from -150 to +300C. Background signals are strong on 19F, B-10, B-11 (BN stator), 1H (water in BN, Vespel and other polymers) and weak on C-13 (Teflon from feed-through, Kel-F from spinner cap or spacers). Please refer to individual probe manuals for more information. CP-MAS probes are high Q designs with correspondingly long dead times. The proton channel of double resonance CP/MAS probes is optimized for high Q but small filling factor, so sensitivity is low on the decoupling channel despite the high Q.

CRAMPS probes:

CRAMPS probes are usually damped to low Q for short deadtime, but the sensitivity is generally better than on the decoupling channel of a CP probe. The Q is usually set to about 45-60 for 200 and 300 MHz, and 100 for 400 MHz where the deadtime is shorter due to the higher frequency. The background signal is strong on 1H from water/boric acid in the BN and from water absorbed on the spinner surface. This proton background is lost in CRAMPS experiments due to the low RF field outside the coil. In single pulse experiments it is, however, visible and requires background suppression pulse sequences. CRAMPS probes are usually tunable from 19F to 1H. It is recommended to order these probes with low 19F background and for 4 mm spinner size, since for 19F observation, fast spinning with single pulse observation is usually more promising than CRAMPS.

Variable temperature experiments with MAS probes:

Current MAS probe designs control the temperature of the bearing gas in order to set the sample temperature. Since the flow rate of this gas is high, and the insulation of these probes (due to spatial restrictions) is not that great, special precautions should be taken with VT experiments. Please refer to the section II, setup procedures, for details. The probe frame flush should be applied at all temperatures, shim tube cooling for all VT operations. The MAS HT probe requires the maximum of safety precautions as listed in section II at temperatures below -100 and above +150C. MAS WVT probes require these precautions below -120C and above +200C. Please refer to the probe manuals also for additional information.

DOR probes:

DOR probes are usually fixed frequency probes which can be tuned over an octave (a factor of 2 in frequency range, centered around the specified frequency). They are available also with proton decoupling. DOR probes work at ambient temperature only.

Standard bore high power probes

1.7.4

Currently, standard bore probes are available for fields up to 750 MHz. MAS probes are available as single X-frequency or single H-frequency or as CP probes with X-observe, 1H decoupling channels. For wide-line X-nuclei observation, there is also a solenoid wide-line probe with exchangeable coils and variable Q. Standard bore MAS probes are spatially more restricted which results in a performance loss compared to wide bore probes.

Please refer to the probe manuals for information.



Please give the probe part and serial number when ordering replacement parts or accessories for any probe

Software description

1.8

The following software descriptions refer to XWIN NMR versions b.16 or later. Older versions will not operate properly with updated hardware, and newer versions will not operate with old hardware.

Spectrometer configuration

1.8.1

In order to operate the hardware properly, the software needs to know what hardware is available. Most of this information, the software can detect itself, but some are not readable via the internal decoder system B-BIS. Therefore, manual interaction is required when the spectrometer is configured. This must be done when new hardware is added or new NMR software loaded. After the configuration is completed, a file with detected or manually entered hardware is displayed and stored on disk under `/u/conf/instr/<spectrometer name>/uxnmr.info`. In the following a brief introduction to spectrometer configuration is given with emphasis on high power components.

The following information must be given to the configurator because the software cannot detect it:

- a. Spectrometer frequency for protons. This frequency must be entered precisely (i.e. 300.13 or 299.87 MHz instead of 300) because from that value the NMR frequencies in the nucleus table are calculated. Note that without a lock the magnetic field can be chosen quite freely as given by the frequency range of all components. With lock, the field range is given by the lock frequency synthesizer that allows 1 MHz adjustment range.
- b. RS232 ports. There is a recommended wiring for RS 232 connections of peripheral units to the CCU interface, but in principle the wiring is arbitrary except for the RXC and 4-phase modulator where a RS 485 interface is used. These ports are interactively requested for the following units:
 - RXC SE-451 controller
 - HPPR preamplifier unit
 - ACB transmitter supervision
 - BSMS shim power supply
 - lock display
 - HPCU high power control unit or 4-phase modulator

The HPCU will not be asked for unless its existence has been entered into the file `/u/conf/instr/<spectrometer name>/hardware_list`. In this file the entries for the essential components of the spectrometer will be found. Usually, the SE 451, the RXC, and 1 T-FX board will be there, also the router board, the ACB and BSMS. The synthesizers are also listed. Note: for a standard PTS 620D only the first

broadband output and the triple mixer proton output are specified by a PTS 620D entry. If the second available broadband output is to be used (for F3), another PTS-620 with 1 output must be listed. These synthesizers have a 1 MHz resolution because smaller frequency changes are executed on the DDS. Any synthesizer used without FCU must have the resolution specified properly. To introduce the HPCU and the high power transmitters, this file must be modified by root including a line.....H5148.....HPCU in a format analogous to other entries. The high power amplifiers must be entered in order to obtain an appropriate EDASP, EDSP setup menu. If the appropriate part number is not known, type „cf makelist“, then a list of all possible hardware will be generated as /u/conf/instr/hardware.exam.

The lines for the appropriate parts should be copied into the hardware list file. Typing cf in UXNMR will ask for the Superuser password and then go through the configuration routine. This will appropriately configure all hardware provided all RS 232 devices are connected and switched on.

With newer instruments without HPCU, the 4-phase modulator must be entered into the hardware list file to establish the RS 485 port through which it is operated upon configuration.

There are however a few caveats.

1. The SE 451 must contain the BBIS prom with appropriate firmware. The BBIS prom is only available in SE-451 units with the full 19 inch front plate, the appropriate firmware can be downloaded with tool software included in XWIN-NMR versions 1.2 or later. This will be necessary if a third TFX board is fitted or the T-FH board is exchanged versus a T-Fx board. Reconfiguration is done using the RX22 tool software, submenu SE451 interface. With older SE-451 units, a special configuration procedure must be done if the unit contains more than 2 transmitter boards or a TFX board instead of the T-FH board.
2. The configuration for B-VT 2000/3000 temperature units must be called separately with cfte.
3. Plotter configuration is done with cfpp and in the SETRES (set resources) menu.
4. If the pneumatic unit is not connected to the HPCU but directly to the CCU interface (watch: special cable required), it must be configured with cfmas. Warning: if it is connected to the HPCU, cfmas must not be done, otherwise communication is expected to take place through the specified RS 232 port. If this was done mistakenly, the file MAS in /u/conf/instr/<spectrometer name>/rs232_device must be removed or renamed.

When all RS 232 channels are defined, the configurator will detect and check the following hardware:

- FADC
- FTLP-4M
- Driver transmitters (through the ACB board)
- TCU and FCU's
- HRD-16, SADC or HADC
- SE-451 configuration (new SE 451 only).
- All available HPPR units if properly coded

Hardware that cannot be checked will be assumed to be present. If necessary, the hardware will be initialized („powered up“), for instance if cf is typed after the hardware was switched off.

EDASP or EDSP

These menus should be called up when the spectrometer hardware is to be configured. EDSP will come up with the current hardware configuration (file „specpar“ in /u/conf/instr/<spectrometer name>. EDASP with the hardware configuration stored in the currently active data set. Usually, EDASP should be used after a data set has been loaded that already has the required setup.

The menu consists of 5 columns. The left most column lists the available frequency channels and the frequencies/nuclei that are set. The second column has the available FCU's, the 3rd the available driver/HR transmitters and the proton transmitter switchbox if available. The 4th column displays the high power transmitters, the 5th the available preamplifiers. Column 1 allows to select nuclei which will automatically also load the appropriate frequency from the nucleus table. It is possible to edit this table to either remove nuclei that are of no interest, or add nuclei, or restore the full table in the cf routine. Refer to the software manual to do this. The offset can also be entered. By definition, the F1 channel is always the observe channel (this is necessary in order to process data with appropriate PPM scaling). Clicking the default button will set the standard RF routing. Clicking the switch F1/F2 or F1/F3 button will make F2 or F3 the observe frequency if 2 or 3 T-boards are available and properly configured. The hardware routing that follows will remain the same in order to have identical conditions. The preamplifier that is connected to F1 via the complete routing chain will be active for detection, other preamplifiers are not used unless an interleaved acquisition is set up.

It is possible to redraw the connecting lines to tailor a desired setup (as long as hardware permits that) by clicking in the two boxes that need to be separated, and then in the boxes that are to be connected. Double selection is prohibited. The connection of amplifiers to preamp pulse inputs must correspond to the routing that is set. The high power transmitters are routed in if the driver transmitter is connected to the high power transmitters, and this is connected to the desired HPPr (in older software, the on box is connected to the HPHPPr). Note that this setting is not activated when leaving the EDASP or EDSP, but that **rackpow** must be typed to set the relays (tube transmitters with power router) or **II** must be typed (B-LAX and B-LAH 1000 transmitters, without power router). In DSX instruments (if configured as DSX), no switchbox will be drawn, and the routing for the transmitters will always be through the high power amplifier since no relay switching is available.

Clicking non selective as preferred preamp configuration, the default button will select preferably the high power preamps. Clicking the param button will show the routing code for the selected routing. The setup is saved when leaving the menu with save, and all routings will be set with the next ii, go, or gs command except the settings that are executed via the HPCU, which are the relay settings in the power router.

EDA or EDHPCU

Both menus are identical in the standard format, except that the EDHPCU menu contains the parameters that are set-able on the HPCU in addition (the powmod parameter is available in both menu's). This allows the solid state users to get rid of all parameters that are never used in order to reduce the menu size. To do this, root must edit the file hpcu.e in /u/exp/stan/nmr/form. All lines belonging to the parameter to be removed must be deleted using any available editor. The sequence of the parameters determine the location in the menu. Again, all set parameters

will be activated when EDA of EDHPCU is left with save, except the HPCU settings for powmod, xgain, hgain, tunex and tuneH, when a go or ii is done. This is necessary in order not to modify HPCU settings if data sets are edited which contain no HPCU information.

HPCU

As explained in the previous section, settings of the HPCU must be explicitly activated for a subsequent acquisition. There are 4 relevant commands. rackpow activates the power mode as specified in powmod. Typing rackpow with powmod=high will turn on the high power rack, and simultaneously route the high power router to the settings specified in EDASP or EDSP. Do not start an acquisition before the high voltage is on which is delayed by about 3 min. Watch the HV LED's at the HPCU keypad to come on. If the routing in the high power router is changed in EDASP, rfackpow must be typed again to activate the new routing. gethpcu will read the tune and gain values from the HPCU and store them with the current data set (acqu and acqu.s file). set hpcu will load these parameters to the HPCU from the current data set. Note that set hpcu will only be able to load the values if the power rack is up because otherwise the stepper motors tuning the high power amplifiers would not run. If an error message „motor poweroff ...“ appears, activate the stepper motors by pressing 2nd function and TUNE X OUT on the HPCU keypad (=MOTOR POWER) to activate the stepper motors.

The ed4ph will allow to read, and store the 4-phase modulator adjustments to and from disk. These files will be saved independently of the data set. Of course they can also be manually modified and loaded into the 4-PM via the HPCU. Note that the 4-PM must be on (AQR rack on) when the HPCU is switched on so that the HPCU can recognize the 4-phase modulator.

Instruments without HPCU (B-LAX 1000, B-LAH 1000)

In newer instruments without HPCU, there are a few differences in setting the transmitter routing and the 4-phase modulator.

- Since the bits originate from the TCU T1 directly, the switching is initiated with an II, zg, or gs. The switching will however activate the mismatch supervision, which takes up to 4s to settle. This means that after setting the bits, ii should be typed so that everything is prepared for a go or gs.
- The bits can be set in the edhpcu menu, powmod array, by setting bits 1 and 2 to on/off for the X- and H- channel. Bit 0 is unused.
- In software versions X-WinNMR 1.2 and 1.3, the edasp menu cannot be used to activate the switches since the relay is not recognized via the ACB BBIS system. There is, however, a trick to allow this also from within edasp: In addition to the 1kW linear amplifiers, recognized by BBIS, add 2 tube transmitters in /u/conf/instr/<instrument name>/hardware_list. Then connecting the lines through or past these tube amplifiers will activate/deactivate the switching to the 1kW stage.
- For DSX instruments, usually the relay will not be present, so the transmitters always work in the 1 kW stage. A third transmitter for f3 should be hardware-coded (front panel of transmitter) as number 3.
- For DMX instruments, an additional 1W/10W stage is available (taken as transmitters 3 and 4).

MAS Pneumatic Unit

The MAS-PU software control is identical whether it is hooked up via the HPCU or directly to the CCU RS 232 interface. In order to be recognized if wired through

the HPCU, the PU must be on and in remote mode when the HPCU is switched on. The same applies when cfmas is executed after wiring the PU to the CCU RS 232 interface.

The pneumatic unit must always be in the remote mode when operated from UX-NMR. There are commands to be typed in the foreground, and there is a MAS menu that communicates to the PU.

Foreground commands: masr, mash, masg, mase, masi allow to set the spin rate, halt the spinner, start spinning, eject or insert the spinner. Safety checks are executed on the PU, error messages are currently not available on the screen display. Note that the commands are not active during an acquisition, A problem may occur if masg is started and the spinner does not spin up. In that case, mash should be executed first. If, instead, the PU is set to manual mode, it may hang up and the spinner may have to be stopped by pressing the „clear“ button. The better way of communicating to the PU is via the MAS menu. Here, all adjustments are available at the same time and the spin up/spin down can be followed by clicking the continuous update button. Please refer to the MAS-PU section for further information.

Pulse Programming

1.8.3

In the pulse program, only fast events executed from the TCU or FCU can be programmed. Refer to the software manual for general information on pulse programming. Here only some general and solids related features are described.

When a new software release tape is copied to disk, also the new pulse program library is copied. Solids pulse programs will be copied to the directory /u/exp/stan/nmr/lists/pp.dsolids. These pulse programs are copied to the....lists/pp directory if expinstall for pulse programs is run. Since release pulse programs usually have the same name through-out all releases, the old pulse programs will be overwritten in pp.dsolids and pp. Therefore it is recommended to save modified pulse programs under different names in order to keep them. It is recommended to follow the format used in release programs. Since the first page of a pulse program is displayed when the pulse program editor is called, the general information about this pulse program should be in this first page. Then calculations of delays, pulses or loop counters must be written, then the include files that are used.

Include files

Several include files with .incl extension are provided. They can be included into any newly written pulse program. To do this, a line# include <file.incl> must be included into the pulse program.

➡ ***The position of this line is important: it must be after any lines which do calculations, it must start without leading spaces, and it must be before any line is used that is defined in this file.***

observe.incl

This file will allow to set the SE-451 channel that is used for observe frequency generation. With XWIN-NMR1.b.6 or later versions, this is not necessary any more since the EDASP or EDSP menu will set this properly. However, when an obsf1,f2,f3 line is used in the pulse program, this will overlay the setting in EDASP. Please note a pulse program written for F1 pulses will execute these pulses on F3 if the routing in EDASP is set for F1 into FCU3, and vice versa. This also applies if F1 and F2 is switched. Also, p11 will then be set on F3 in an analogous way. If the

observe channel is set inside the pulse program, the pulse routing will not be changed, i.e. pulses written as F1 will come from the F1 transmitter.

preamp.incl

This file is essential for all experiments if pulses are transmitted via the HPHPPR preamplifiers (high power preamplifiers). During a pulse, the preamplifier must be blanked, and for observe, it must be opened. The software will automatically compile blanking pulses for the preamps into the pulse program. However, the blanking pulses compiled in for high power preamps are currently not wired to the preamplifier blanking logic. Since all preamplifiers are simultaneously blanked, it is sufficient to include a line in the beginning of the pulse program that blanks any HR preamplifier. The line protect defined in preamp.incl executes a blanking bit for the proton HR preamp and simultaneously blanks all preamplifiers. However, this blank is overruled for the observe preamplifier when the receiver is opened with a go or adc command. If any pulses are executed via the observe preamplifier after an adc command, they should have a:e wherever no signal needs to be observed to blank the receiver and preamplifier when not detecting.

powswi.incl

This file defines the bits which are used to switch between the highpower transmitter gain levels set by the HPCU keypad or in EDHPCU with subsequent set hpcu. Entering a line like hgain4 will set whatever gain is set for level 4 on the proton/fluorine high power transmitter. If the fast grid voltage switching is not available, the gain levels xgain1 and hgain1 will be used throughout.

trigg.incl

This include file executes a short trigger pulse accessible at the highpower router control module. The NMR5-13 bit is used. Other bits can be activated similarly. Please note that setnmr(n)|(m) sets the bit m on control word n until it is cleared with a line setnmr(n)^(m). Bit 13 is reserved for triggering an oscilloscope.

Synchronizing a pulse sequence to external events.

4 external trigger inputs are available. 2 of them are accessible via SMB connectors at the TCU front panel. They are labeled TRIG0 and TRIG1. TRIG2 and TRIG3 are wired through the TCU1 T1 SCSI bus cable to the high power router (see previous chapter on TCU).

These external inputs are addressed by software in the following way:

- a. The software considers TRIG0 as trig1, TRIG1 as trig2.... and so on.
- b. The trigger event can be set by trigger levels low or high, positive or negative edges.
- c. A line trigpe2 will trigger on the positive edge of TRIG1 trigpl4 will trigger on the positive level of TRIG3 and so on.

The pulse program will wait until the trigger condition becomes true. For rotor synchronization, edge triggering is required.

In instruments without HP rack (B-LAX 1000 and B-LAH 1000 amplifiers), the trigger cable may be connected to the TCU T1 adaptor or the T1 connector at the B-LARH 1-10 (1 W and 10 W stage), or to the back panel BP1 connector pin NN, TRIG0. In the latter case, the trigger must be addressed as trig1 in the pulse program.

Programming phase shifts

If phases are given as numbers, they will be executed on the DDS. If given as +/- x, +/- y, they are executed on the 4-phase modulator. As pointed out before, in older software/hardware, they are mutually reset to 0, in new software/hardware, they are executed independently. 4-phase modulator pulses can also be included into composite pulse decoupling programs (XWIN-NMR1.b.16 or later) so multipulse decoupling for instance with a blew-12 sequence is very easily programmed. Receiver phases can only be controlled via the DDS phase shifter from within the pulse sequence.

Digitizer Types.

The „slow“ digitizers HRD16, SADC, or HADC work in a somewhat different way than the FADC, and this must be taken care of in pulse programs where external address advance is required. Due to the speed of data generation, the FADC has a pipeline structure. This means that sampled data points are shifted into the SRAM memory with every new data point generated simultaneously. After td data points are sampled, $td-3$ data points have been delivered to the acquisition memory hence the RCU is waiting for 3 more which will not be delivered unless 3 more data points are sampled. This means that in external address advance sequences, $td + 3$ p0:xlines must be executed with $digtyp=FADC$, however only td p0:x lines are necessary with „slow“ adcs. It should be pointed out that in those cases where digital filtering can be applied (that is when sufficient time for the signal processing is available) this can be successfully done with external address advance just like for internal address advance. In that case, the loop counter generating td data points must be calculated with a multiplier according to the over sampling that is used. Usually, a loop couture would be calculated at the beginning of the pulse sequence with `define loop counter count`

„count=decim*td“ when one line with p0:x is inside the loop.

This applies for use with slow adcs. With FADC, the calculation would be:

„count=(decim*td)+3“

The BC-133 may be equipped with ADC chips from different manufacturers. All have a common problem which for some types is less, for others more annoying. The DC level will change for the first 300-2000 nsec depending on the make. This DC offset will usually cancel on consecutive scans, however it is still advisable to start the acquisition well before the signal starts and then left shift the FID to the desired point.

Standard Setup Procedures

2

RF Architecture of AVANCE Spectrometers

2.1

Please refer to the High Power Users Manual for more detailed wiring information. A few general points should be discussed:

- a) Differences between DMX and DSX instruments
 - b) Frequency ranges of RF channels, frequency generation.
 - c) Differences between X-tube amplifiers and linear high power amplifiers.
-
- a. Differences between DMX and DSX instruments. The general difference is that DMX instruments have all high resolution capabilities, whereas DSX instruments have only solids capabilities. This normally means that DSX instruments have no lock and a dedicated driver amplifier, B-LAXH, that does not provide the power to operate high resolution probes. It can only be used to drive the high power tube amplifiers. Therefore the relay switches in the power router are not required and the drivers are directly connected to the tube amplifier inputs.
 - b. Frequency ranges of RF channels. The standard 2 channel DSX or DMX will have a PTS 620 with 2 fully broadbanded synthesizers plus 1 dedicated proton frequency generator, the so-called triple mixer. The SE-451 will have a T-FX board that can generate all frequencies up to tritium frequency, plus 1 T-FH board that generates proton frequency only. Please note that the frequencies going to the SE-451 are [NMR-frequency 440 MHz]. Both boards can provide the reference frequency for detection. If both channels have to be broad banded, the T-FH board can be replaced by a T-FX board which then must be fed by the second full synthesizer inside the PTS-620, not by the triple mixer. This must be configured in the software for proper frequency generation in the corresponding FCU. In older 2-channel SE-451s, this is done in the hardware list file by entering 2 entries for a T-FX board. In newer SE-451s, recognized by the full 19 inch front plate, there is slots for up to 3 T-FX/T-FH boards. Here the configuration can be done in the built-in B-BIS PROM that is read by the software upon spectrometer configuration with cf, provided that the PROM has been loaded with appropriate information with the RX22 tool software. All frequency channels that are not routed via a SE-451 T-FX or T-FH board, cannot be used for detection, and the frequency generated in the synthesizer is the NMR- frequency without mixing. Therefore, the frequency range is given by the synthesizer setting range. This applies of course also for the fourth and higher frequency channels of an instrument with 3-channel SE-451.
 - c. Linear high power amplifiers require no driver transmitter. Therefore, the ASU output is wired directly into the high power transmitter input (DSX), or into a pin

Standard Setup Procedures

diode switch module in the high power router in the case of a DMX instrument, in contrast to the standard wiring shown below.

The following block diagrams are simplified and refer to instruments with tube amplifiers. The units shaded in grey or labelled grey are options.

DMX RF wiring

2.2

Figure 2.1. DMX RF Wiring

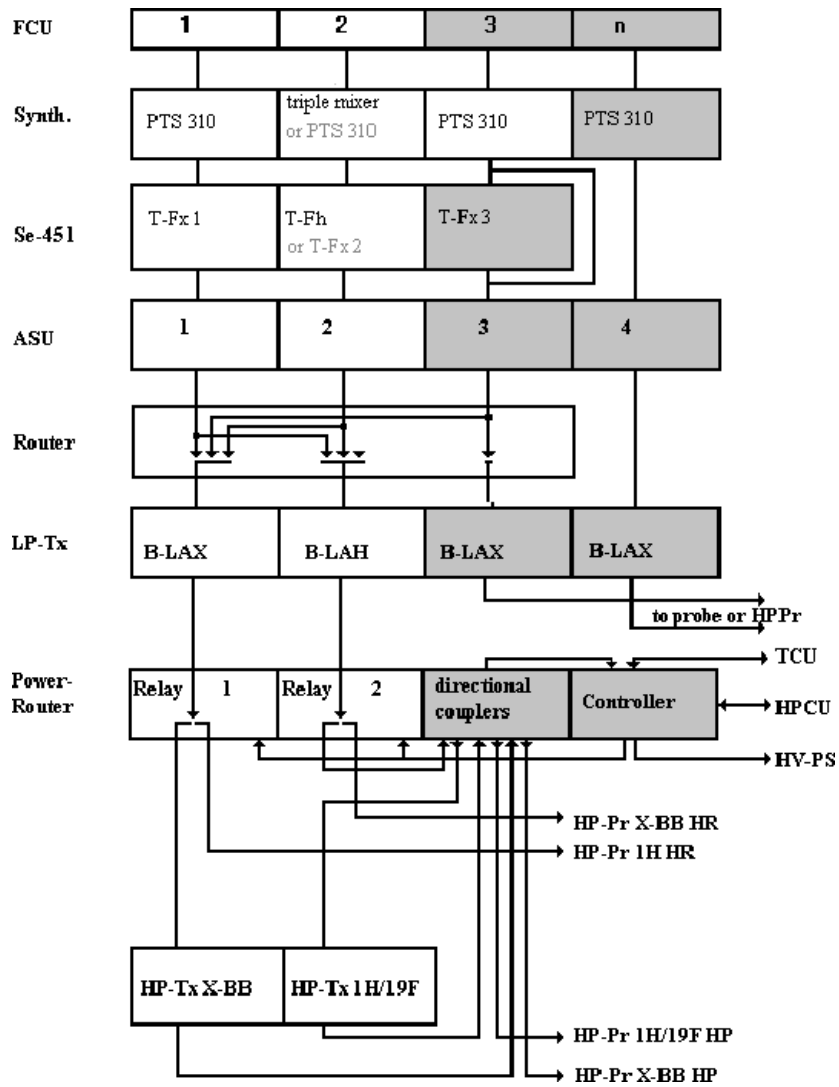

Figure 2.4. DSX RF Wiring

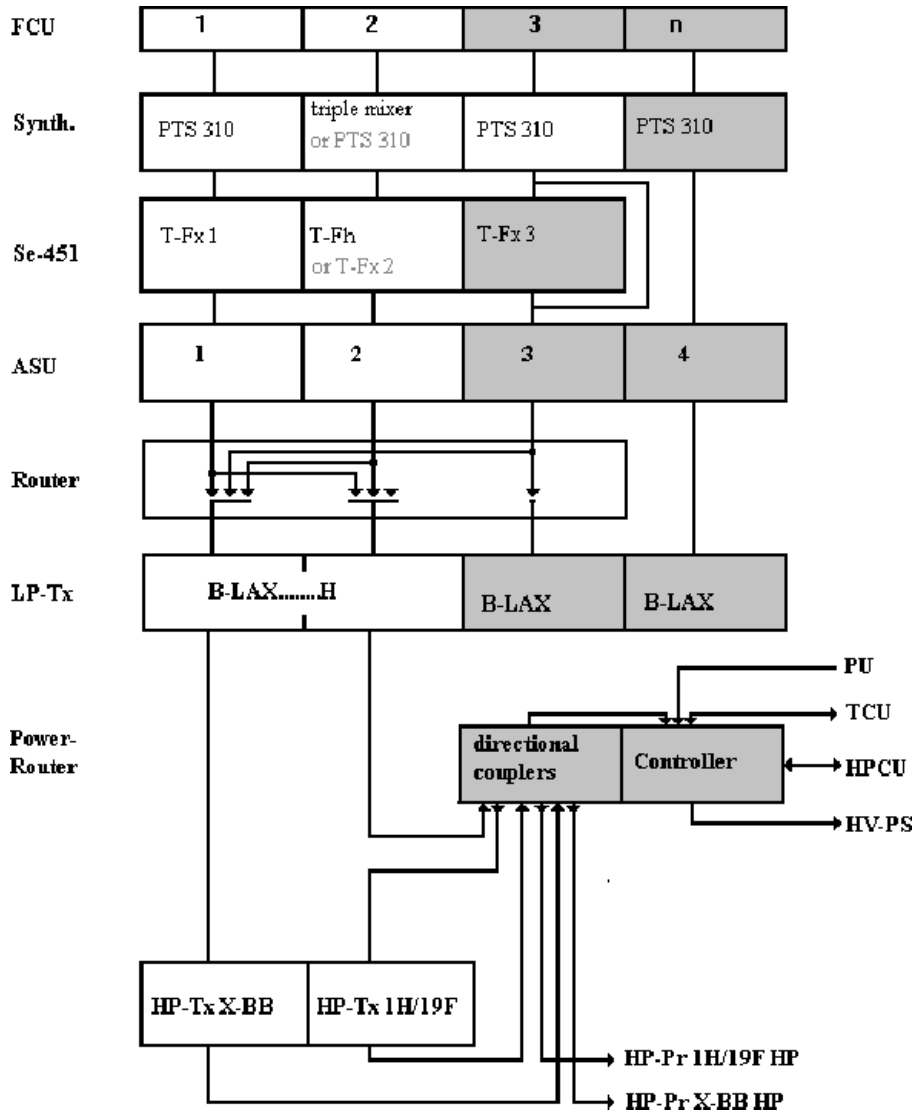
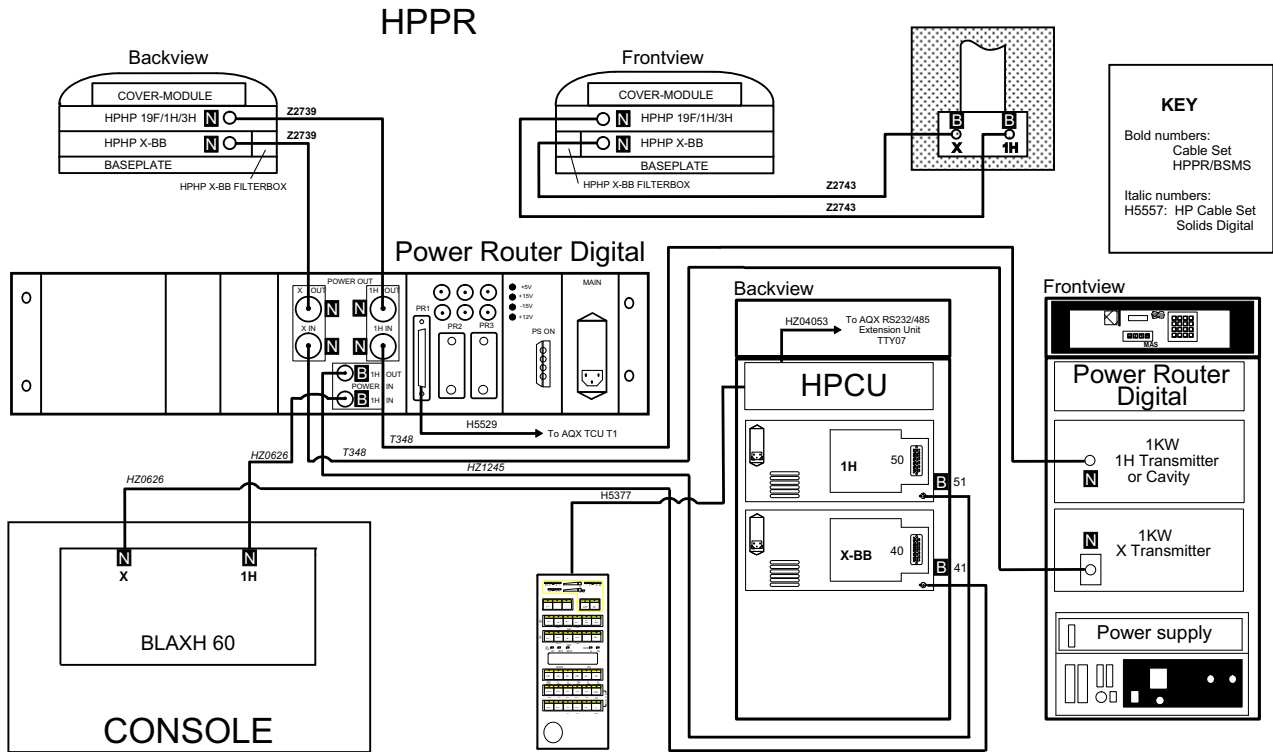

Figure 2.5. DSX 100, 200, 300, 360, 400 High Power

DSX 100, 200, 300, 360, 400 High Power



NIL 3.01.95 DSXHP234.DS4

Figure 2.6. DSX 500 High Power

DSX 500 High Power

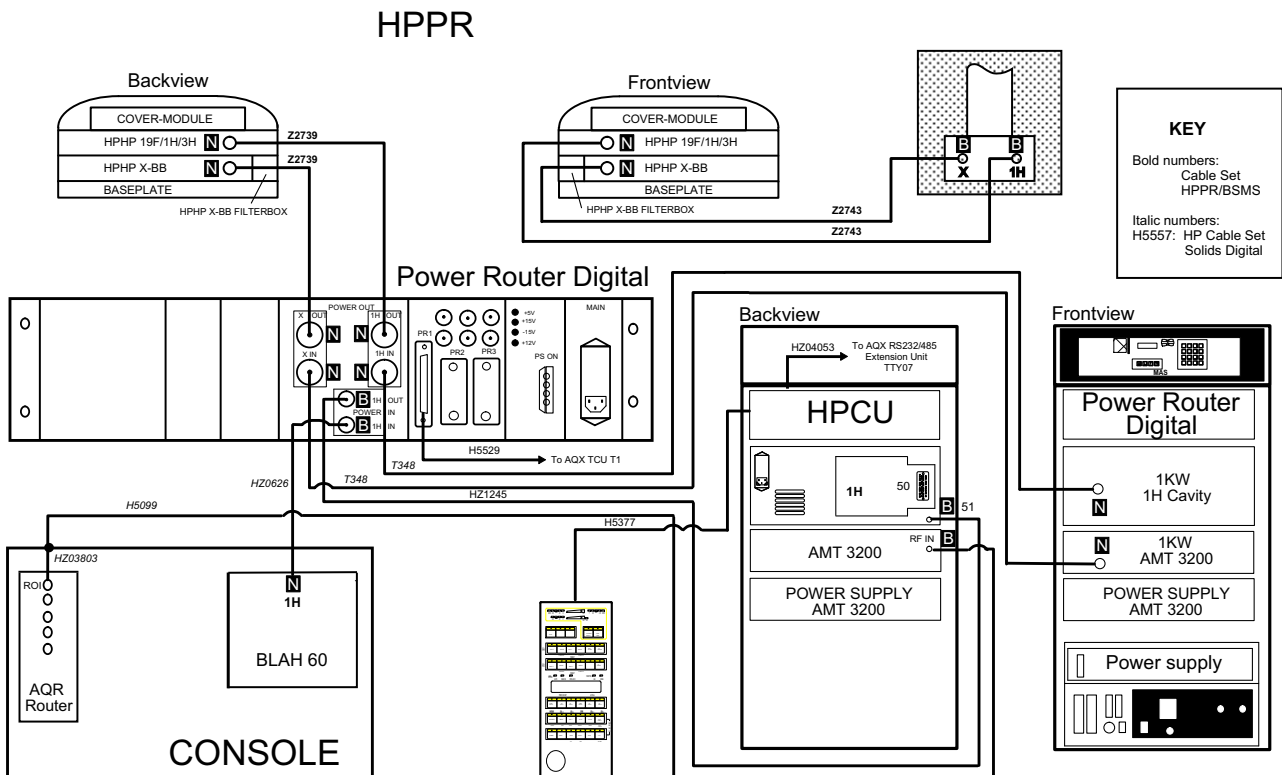

NIL 3.01.95 DSXHP5.DS4

In the following, the probe connections are shown for different types of experiments. This refers to connections of RF cables and other cables and hoses to the probe.

a) X-nucleus wideline experiments or single frequency MAS

Figure 2.7. X-observation

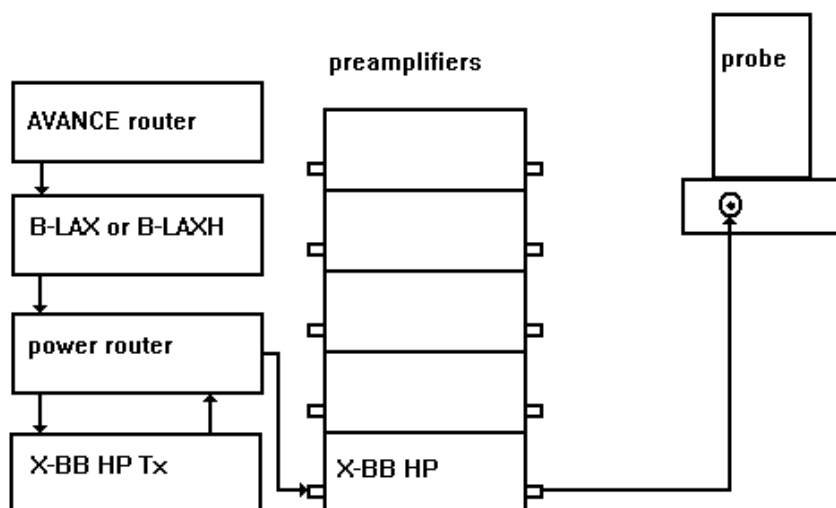

The X-BB-Tx output always remains wired to the X-BB-HPPr preamplifier. Make sure the appropriate matching box is inserted into the preamplifier which contains the desired NMR frequency.

⇒ Pulsing into the incorrect matching box will damage it!

Figure 2.8. EDASP menu for a 2H wideline experiment with a DMX 300

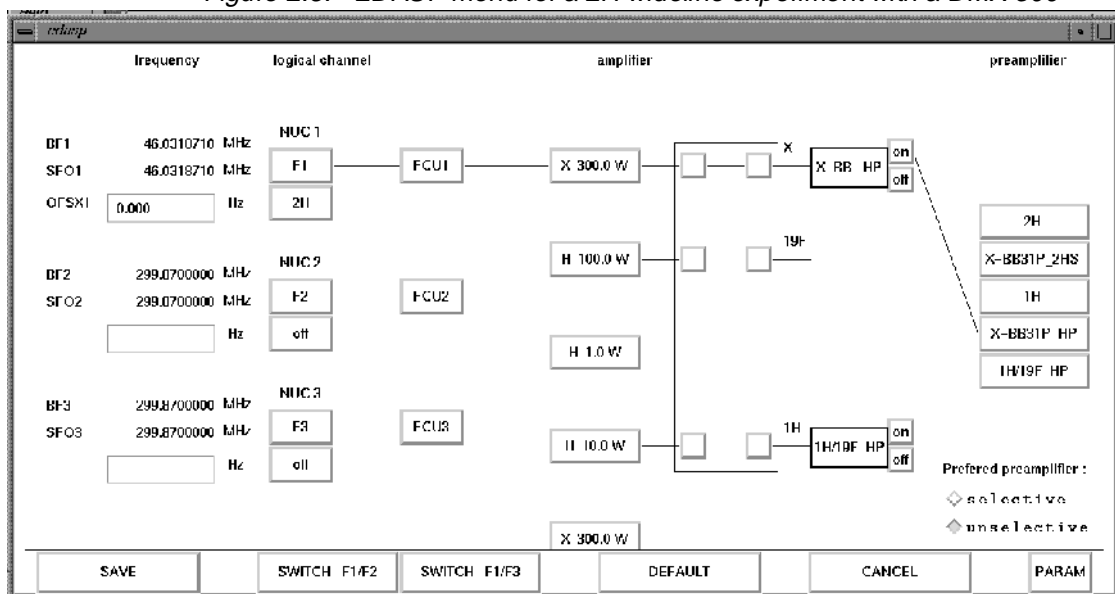

b) 1H/19F wideline experiments

Figure 2.9. 1H/19F wideline experiments

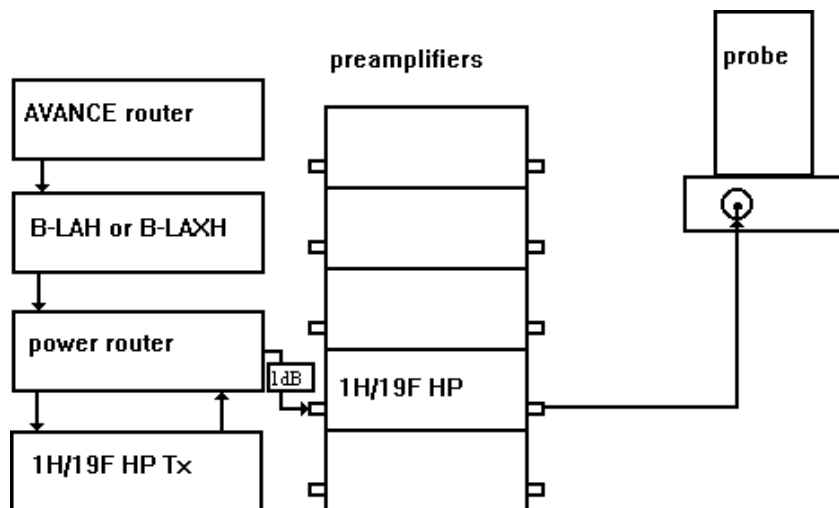

The proton high power transmitter should be connected to the 1H/19F/3H HP-HPPr only for proton, 19F or 3H observation, preferably via a 1 dB attenuator box. For decoupling, the transmitter should be wired to the probe directly unless the experiment requires a delicate setup with observation on protons.

Figure 2.10. EDASP setup menu for a DMX 300 observing protons

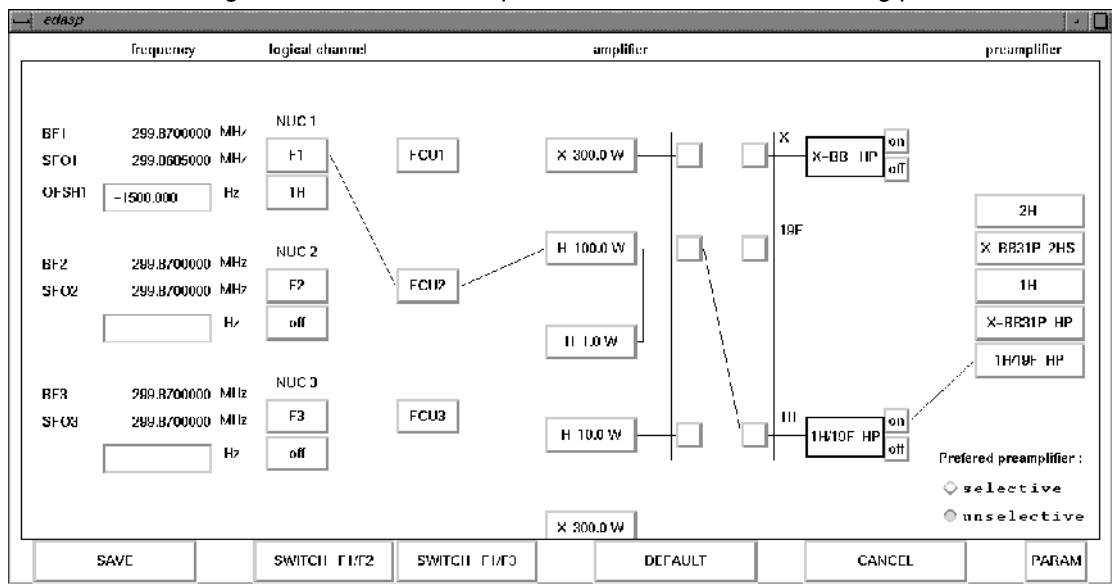
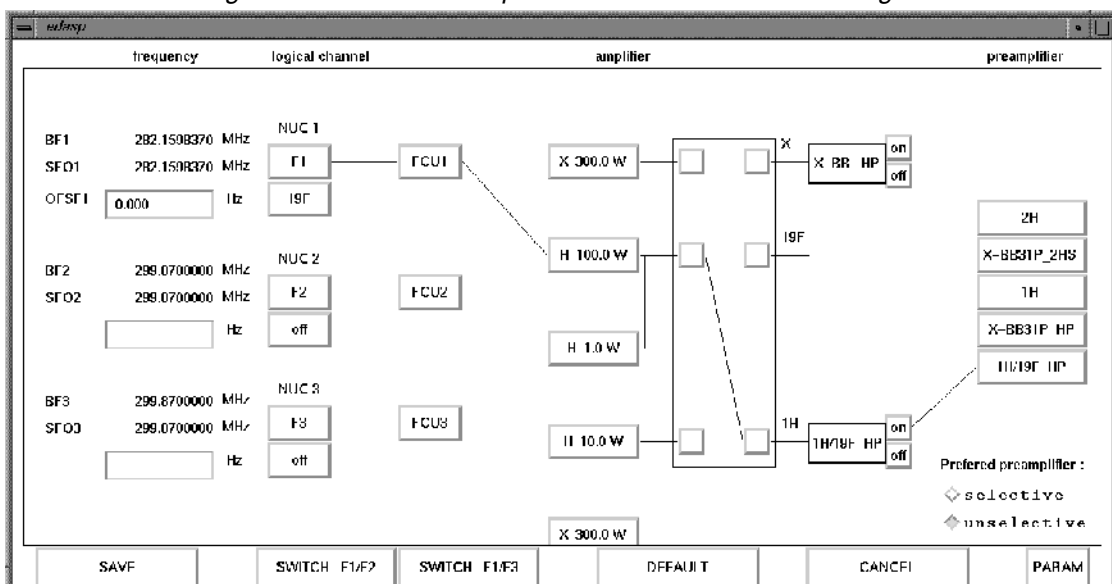
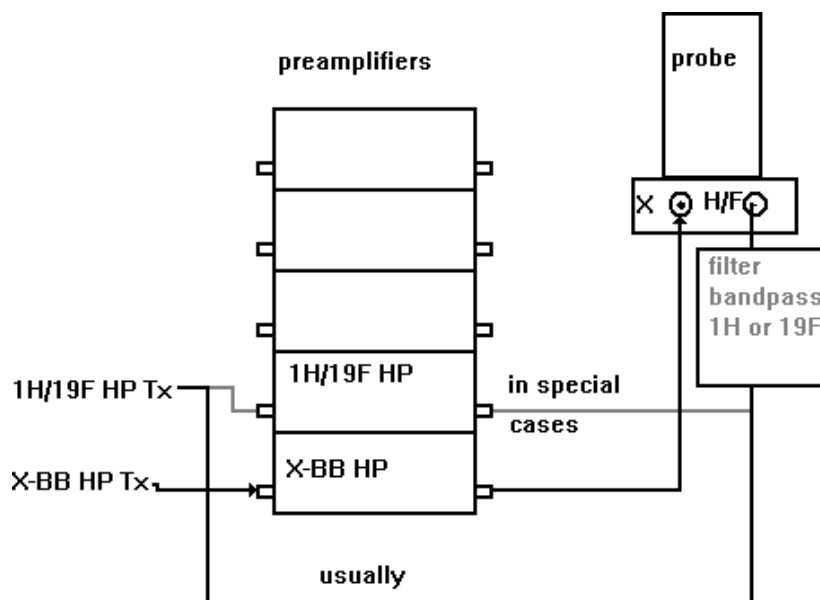

Figure 2.11. EDASP setup menu for a DMX 300 observing fluorine



c) double resonance experiments X-H or X-F

Figure 2.12. double resonance experiments X-H or X-F



In special cases, the proton or fluorine decoupling pulses may be transmitted via the preamplifier, namely when the probe and experimental parameters had to be set up in a 1H or 19F direct observe experiment, and rewiring would change the experimental conditions. In that case, long decoupling periods (>50 ms) should be avoided.

Figure 2.13. EDASP setup menu for a DMX 300 observing C-13 with proton decoupling

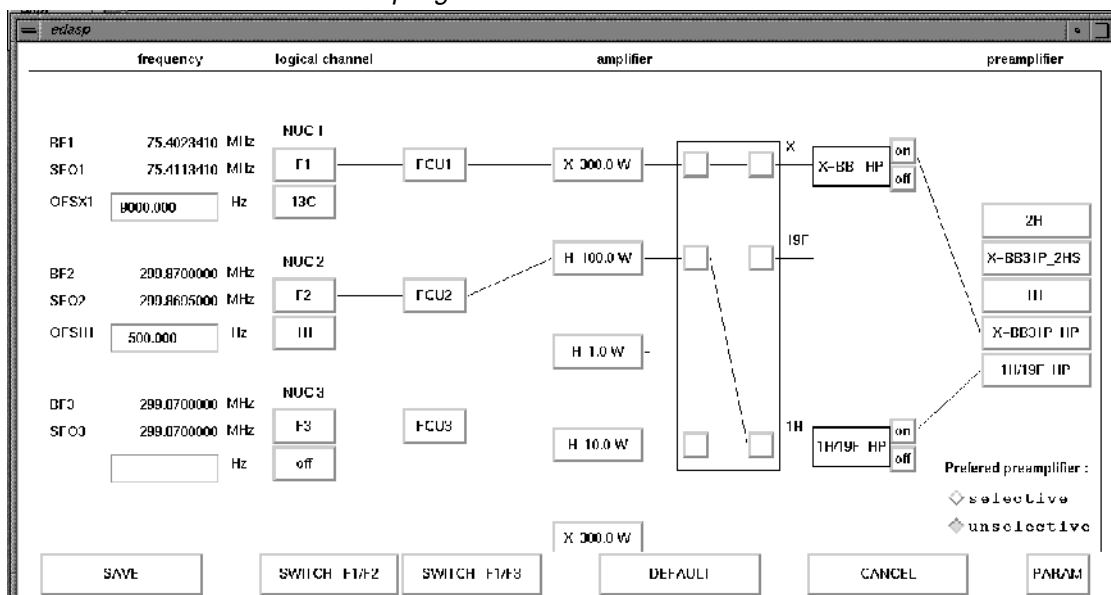

Remember to type rackpow or II (BLAX 1000 or BLAH 1000 with relays) after changing the transmitter routing from using the high power to using the low power amps and vice versa!

Figure 2.14. EDASP setup menu for C-13 observation and proton decoupling

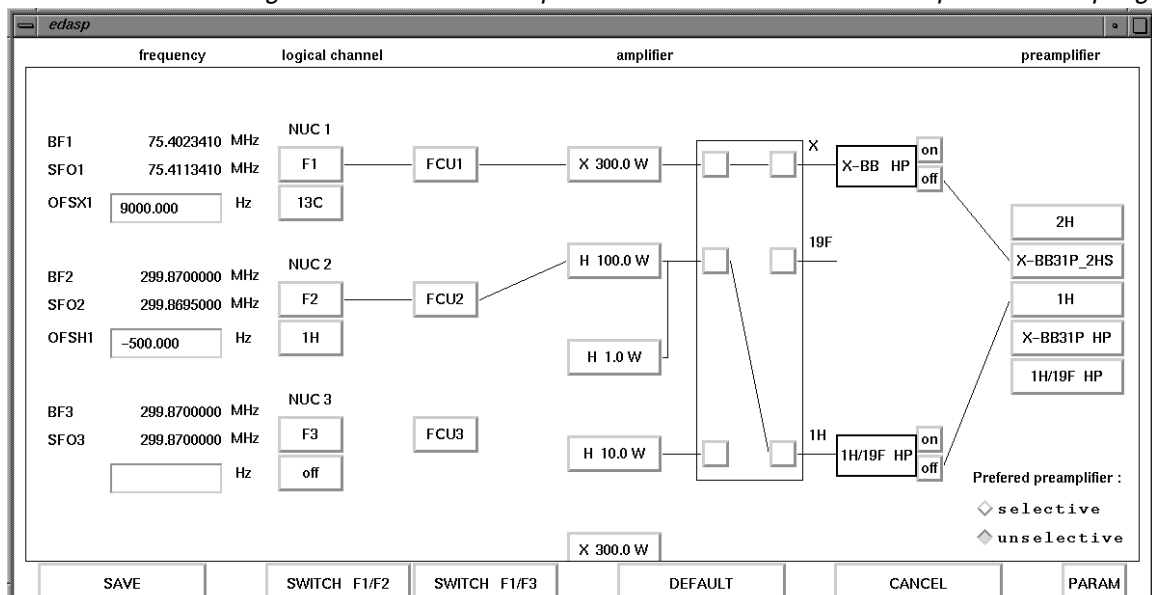

Using the low power HR amplifiers (DMX only)

Remember to type rackpow after changing the transmitter routing from using the high power to using the low power amps and vice versa!

Figure 2.15. EDASP setup menu for a DMX 300 observing C-13 with fluorine decoupling

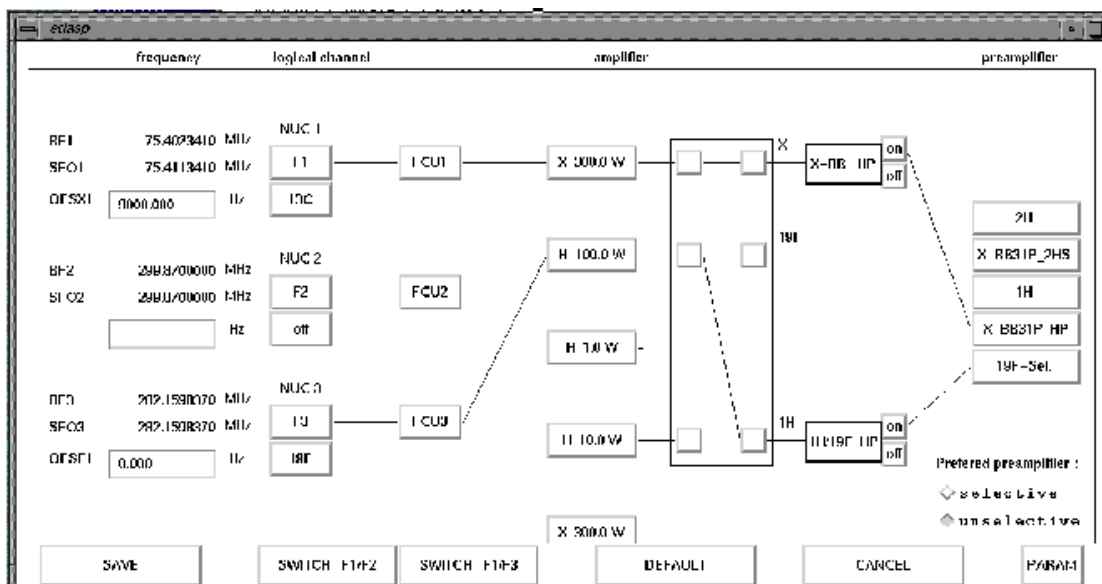

Using HP transmitters and the F3 channel for fluorine frequency generation.

Remember: In a two channel instrument, a broadbanded T-Fx board instead of the narrowbanded T-Fh board is required to perform this experiment!

d) triple resonance experiments X-Y-H

Figure 2.16. triple resonance experiments X-Y-H

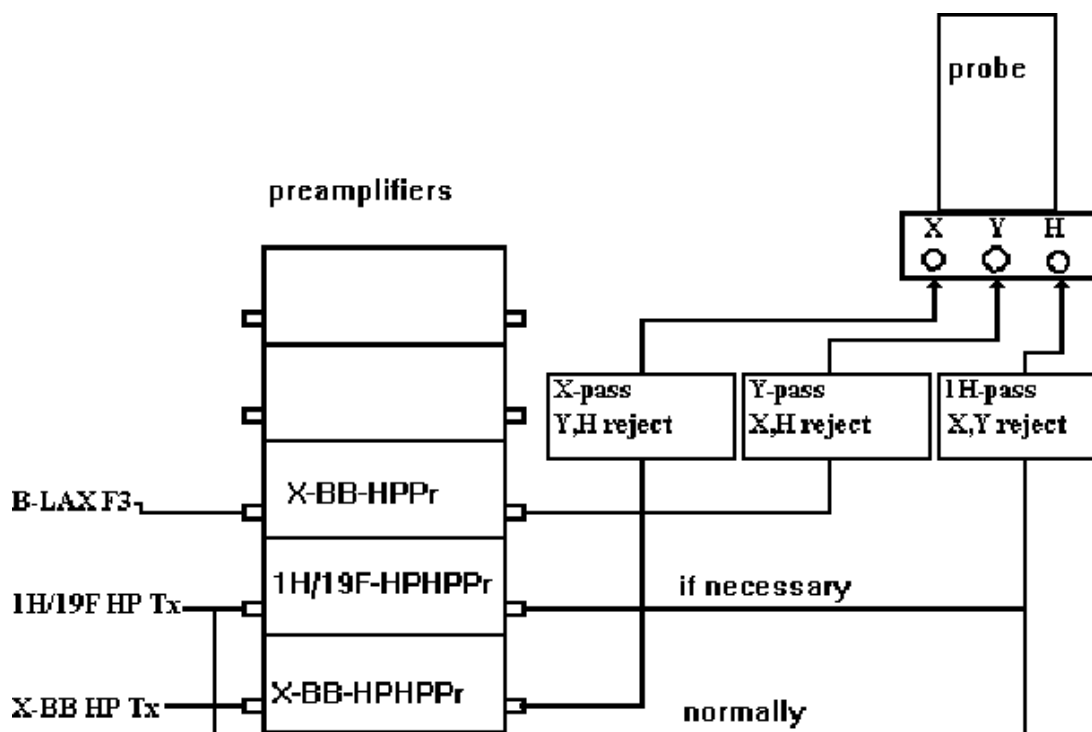

If observation on F3 is wanted, the F3 transmitter must be wired through a suitable observe preamplifier. If available, the standard high resolution X-BB preamplifier can be used together with a B-LAX 300 F3-transmitter since the maximum power output of this transmitter does not exceed the power handling capability of the preamplifier multiplexer. The connection of the F3 transmitter to the preamp must be done manually. Appropriate filtering is mandatory, since otherwise noise from a decoupling channel may affect the quality of the spectra, or a pulse from one of the transmitters may affect any other linear solid state transmitter activating the mismatch protection circuit. This may cause a pulse from that transmitter to be suppressed, especially when two pulses are executed simultaneously. Tube amplifiers are not affected since a mismatch protection is not required.

Standard Setup Procedures

Figure 2.17. EDASP setup menus for a DMX 300 observing C-13

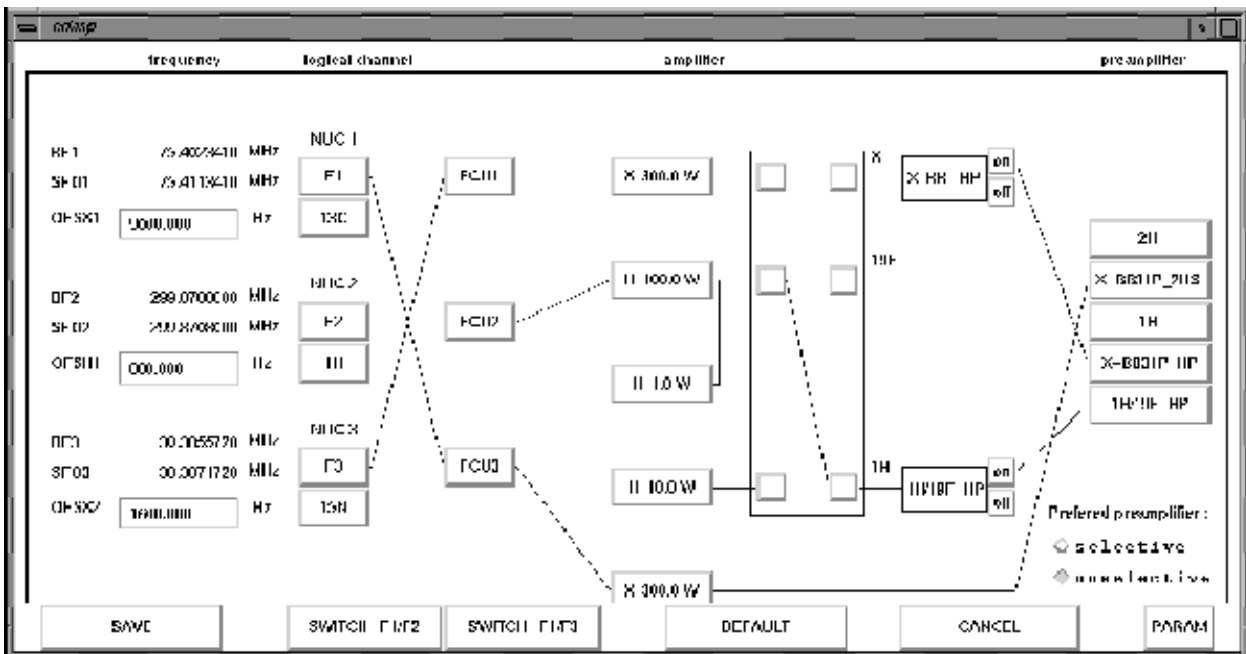

While decoupling protons and pulsing on N-15. The instrument is equipped with a 3-channel SE-451 with a T-FH board for protons only. This setup uses the 1 kW high power amplifier for the N-15 channel where more power is required. The observe frequency is carbon which is defined for the observe channel F1. Note that the pulse program must be written for carbon pulses on F1, even though the carbon pulses come out of the F3 transmitter.

Figure 2.18. EDASP setup menus for a DMX 300 observing N-15

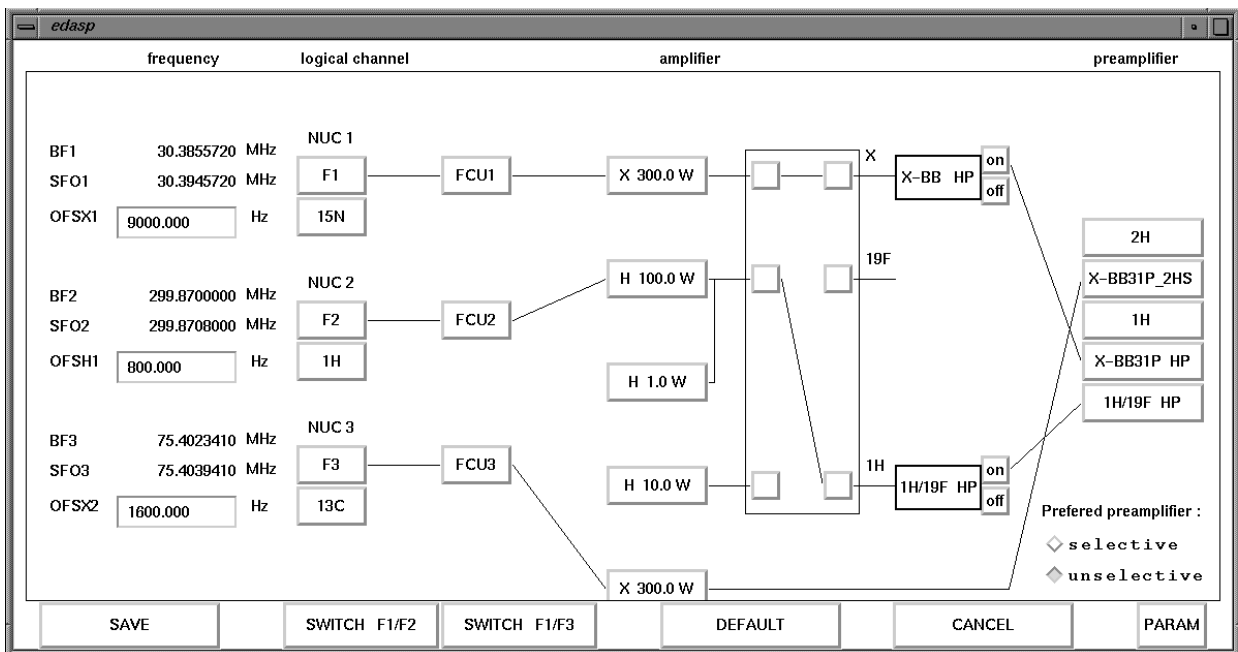

While decoupling protons and pulsing on C-13. The instrument is equipped with a 3-channel SE-451 with a T-FH board for protons only. This setup uses the B-LAX

300 for the C-13 channel which will usually provide sufficient power. The selection of the observe transmitter is arbitrary, but it is recommended that tube amplifiers be used for decoupling during acquisition because they put out less noise and filtering is easier. Please note that this setup menu and the previous one are generated by activating the SWITCH F1/F3 button. Care must be taken that the observe preamplifier (always the one that wires back to the F1 „software“ channel) is connected to the probe and the appropriate matching box is inserted.

For experiments X-Y-F-19 or X-Y-Z, an instrument with 3 T-FX boards and 3 full synthesizers is required.

If the SE-451 is equipped with 2 channels only, the EDASP setup looks very much the same, but observation on the 3rd channel is not possible.

MAS-PU and VT connections

2.5

VT connections

2.5.1

Here the connections of thermocouples and cooling or heating gas are described. These connections are the same for B-VT 1000 or B-VT-2000 temperature control units. However, it should be noted that for thermo-couples that are not standard and for high temperature MAS probes with drive gas heating, the temperature controllers must be reconfigured. Standard thermocouples are copper-constantane. Other thermocouples require a special plug-in for B-VT 1000 units, or a different configuration for B-VT 2000.

Please note as well that for extreme temperatures, additional safety precautions are required to maintain the temperature of the room temperature shim tube and the magnet inner bore tube at acceptable temperatures.

The maximum temperature of these components is given by the room temperature shims which will be destroyed at temperatures above 70 C, the minimum temperature is given by magnet safety considerations. Here it is difficult to specify a minimum safe temperature. The problem is the O-ring seals of the magnet inner bore tube which may freeze stiff and then the magnet vacuum may be lost. In general, the magnet is safe as long as the lower part of the shim systems shows no icing. These safe conditions are met as long as additional ambient temperature gas flow is applied to the probe flush connectors and to the shim system as described below. Under appropriate conditions, the probe outer shell may have temperatures between +100 C and -80 C at the shell upper part.

Safety precautions for extreme temperature operation:

2.5.2

a) Stationary CP probes, 1H/19F wideline probes, X-wideline probe

Here the insertion of an additional glass tube (H) is recommended. This tube is inserted into the upper part of the shim system and connects to the bell shaped glass dewar inside the probe. This tube will lead the hot or cold VT gas straight out of the shim system.

Standard Setup Procedures

b) All probes

For all probes the following flush gas connections are possible: The frame cooling gas from the PU (if available) should be led to the probe frame cooling inlet (N2 for low temperature operation). This is mandatory.

The shim cooling connector is located at the lower flange of the shim system upper part at the magnet top. This should be flushed with dry gas (not necessarily nitrogen) to isolate the shim system from the magnet inner bore tube. The gas flow should preferably be taken from a separate adjustable compressed gas outlet. A flow of 500 l/h should be achieved.

If no separate outlet is available, the high resolution spinning outlet may be used setting the high resolution spinning on. (yellow connector at the shim system upper part). This is also mandatory.

Additionally, the following flush port may be used as an option:

- For low temperature MAS operation, it must be prohibited that ambient air is sucked into the MAS transfer system. This is most efficiently done by having a slight flow of nitrogen into the insert connector.

All systems delivered with MAS-HT probes should have a flush gas distributor which is inserted between the compressed gas supply socket and the PU inlet. It allows to connect additional flush lines to ports as described above with adjustable flow. It can be ordered for other probes as B-VT 2000 connections and configuration

Figure 2.19. B-VT 2000 connections and configuration

B-VT 2000 rear panel

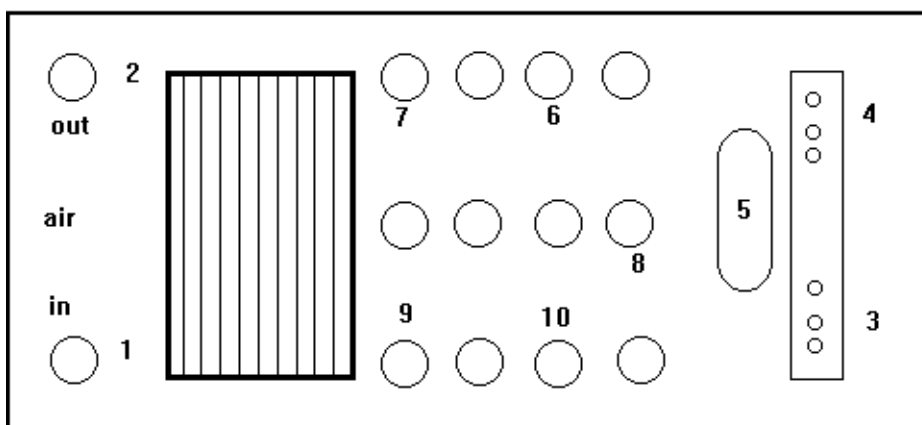

- | | |
|--|--|
| 1 compressed air or N2 in, max. 8 bars | 2 VT gas out to probe |
| 3 thermocouple Cu/const in | 4 thermocouple chromel/const in |
| 5 RS 232 to CCU | 6 heater to probe |
| 7 high/low switch for heater current | 8 control out for drive gas slave unit |
| 9 high/low switch for LN2 boil off | 10 heater for N2 boil off |

The B-VT 2000 serves as temperature controller for all BRUKER probes. It supports the following temperature sensors:

- Pt-100 thermo resistors (not used in high power probes).

- Copper-constantane thermocouples (Cu/const), used in probes with standard temperature range.
- Chromel-constantane thermocouples, used in probes with extended temperature range.

To change between probes with different temperature sensors, the B-VT 2000 must be manually reconfigured. It must also be reconfigured, if a slave board was installed to control a slave unit (used for old style high temperature MAS probes).

Pneumatic unit connections

2.5.3

The pneumatic unit is connected to the compressed gas supply (dry air or nitrogen) with a maximum pressure of 10 bars. It will operate at pressures as low as 5 bars at the inlet. Lower pressure may lead to malfunction of the pneumatic valves. If operated from a pressurized liquid nitrogen boil off tank, care must be taken that the evaporated nitrogen is warmed up to at least +10 C before it is fed into the pneumatic unit.

Figure 2.20. Pneumatic unit connections

MAS PU rear panel

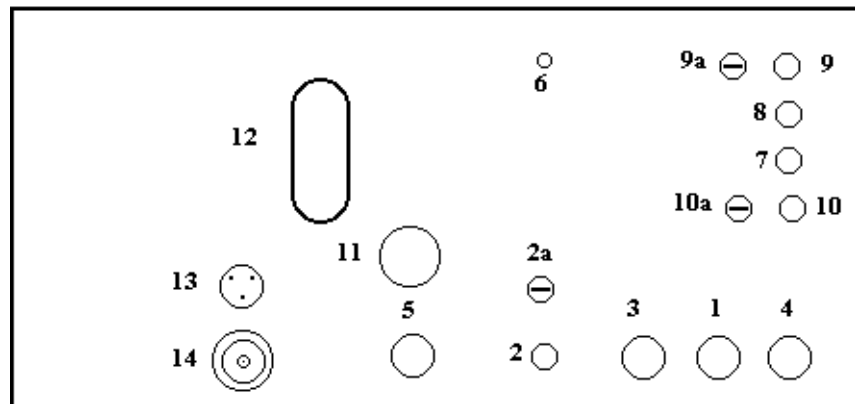

- | | |
|-------------------------------------|---|
| 12 RS 232 cable to HPCU or CCU | 13 spin rate cable to probe |
| 14 sync trigger to power router/TCU | 11 air or N2 in (max. 10 bar), 10 mm dia. |
| 5 drive out to probe or heat exch. | 6 bearing sense line to bearing line |
| 2 eject to rotor transfer system | 2a eject adjust |
| 3 bearing to probe or heat exch. | 1,4 -70 or -120 bearing to old style heat exch. |
| 9 insert to rotor transfer system | 9a insert adjust |
| 8 magic angle position (SB probe). | 7 vertical position for eject (SB probe) |
| 10 frame cooling (flush) | 10a frame cooling adjust |

MAS heat exchangers

2.5.4

There is four types of MAS heat exchangers available.

- Old type with variable loop length
- New type with variable flow through the exchanger loop single one turn loop for SB MAS probes

Standard Setup Procedures

- c. New type with variable flow through the exchanger loop single double turn loop for standard VTN and WVT MAS probes
- d. New type with variable flow through the exchanger loop two double turn loops for HT MAS probes and VTN MAS probes modified for drive gas cooling.

Figure 2.21. Old type with variable loop length

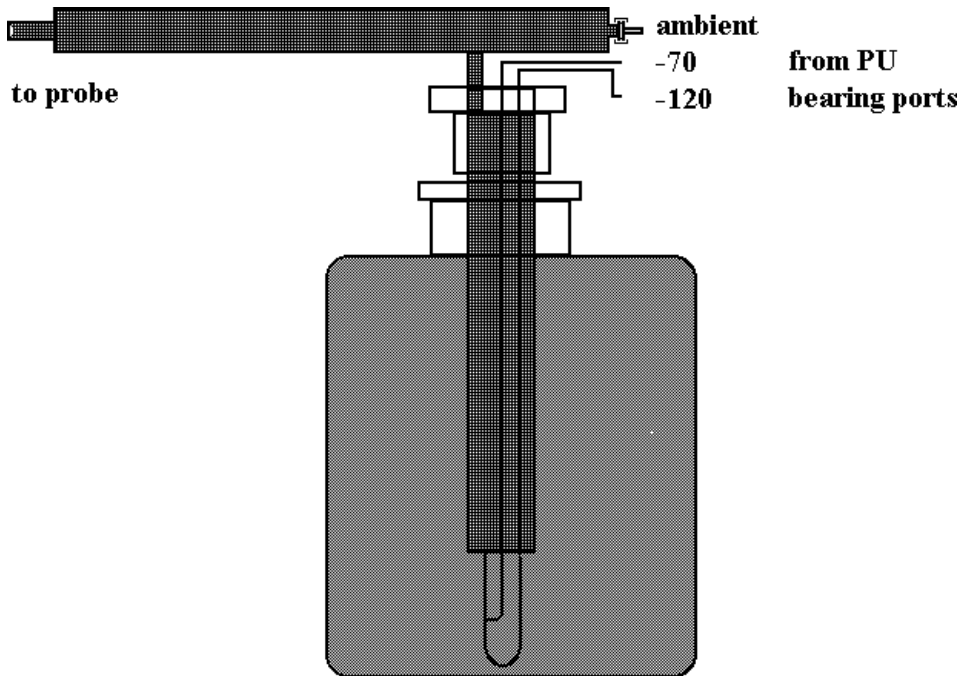
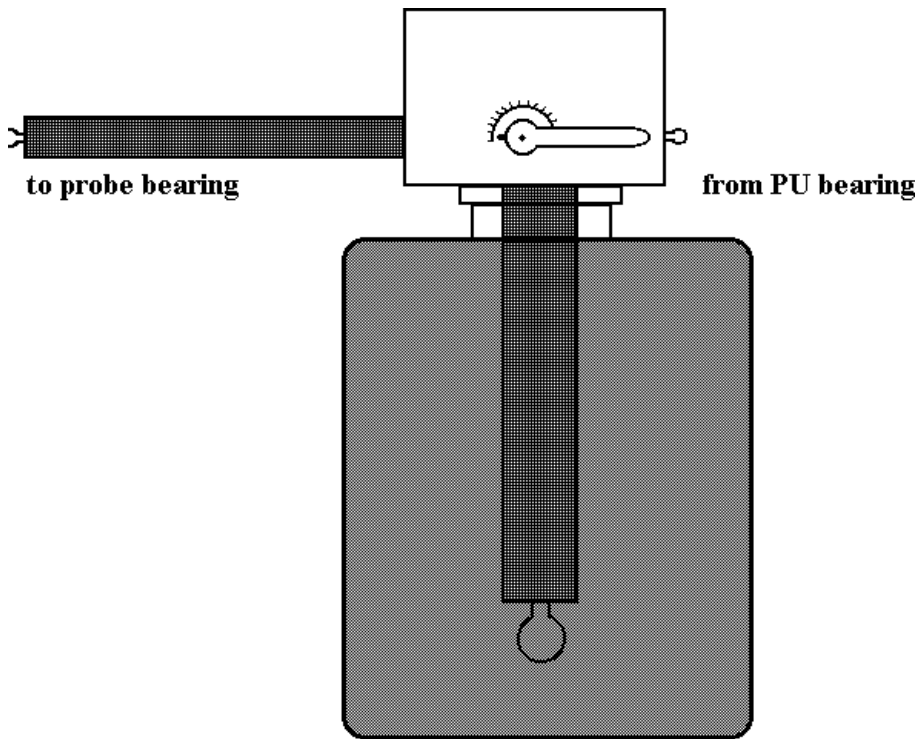
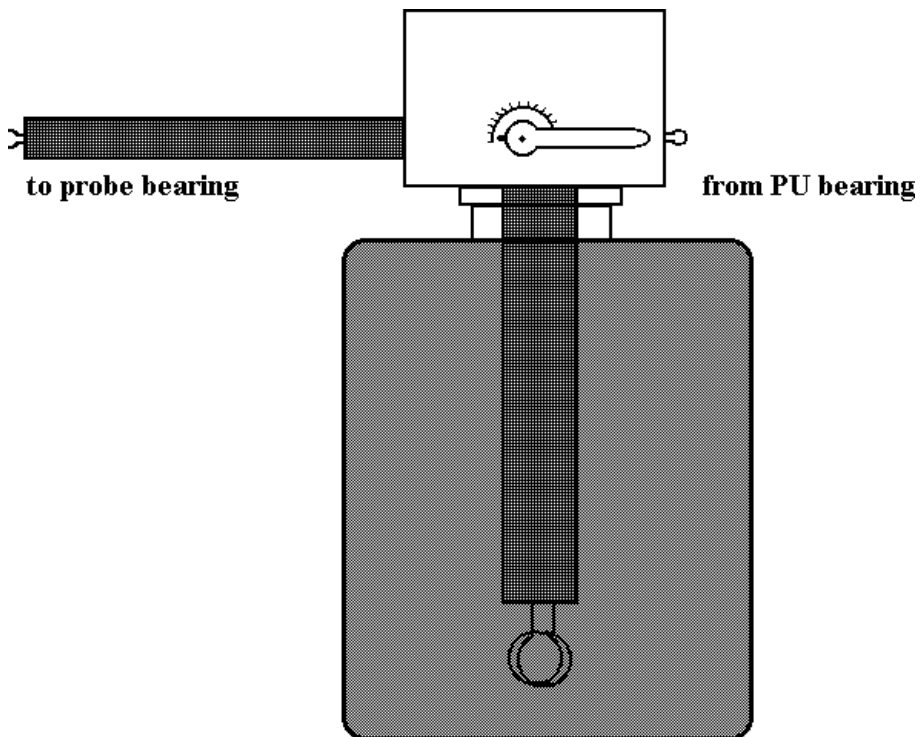

Figure 2.22. New type with variable flow through the exchanger loop



Single one turn loop for SB MAS probes

Figure 2.23. New type with variable flow through the exchanger loop



Single double turn loop for standard VTN and WVT MAS probes

Figure 2.24. New type with variable flow through the exchanger loop

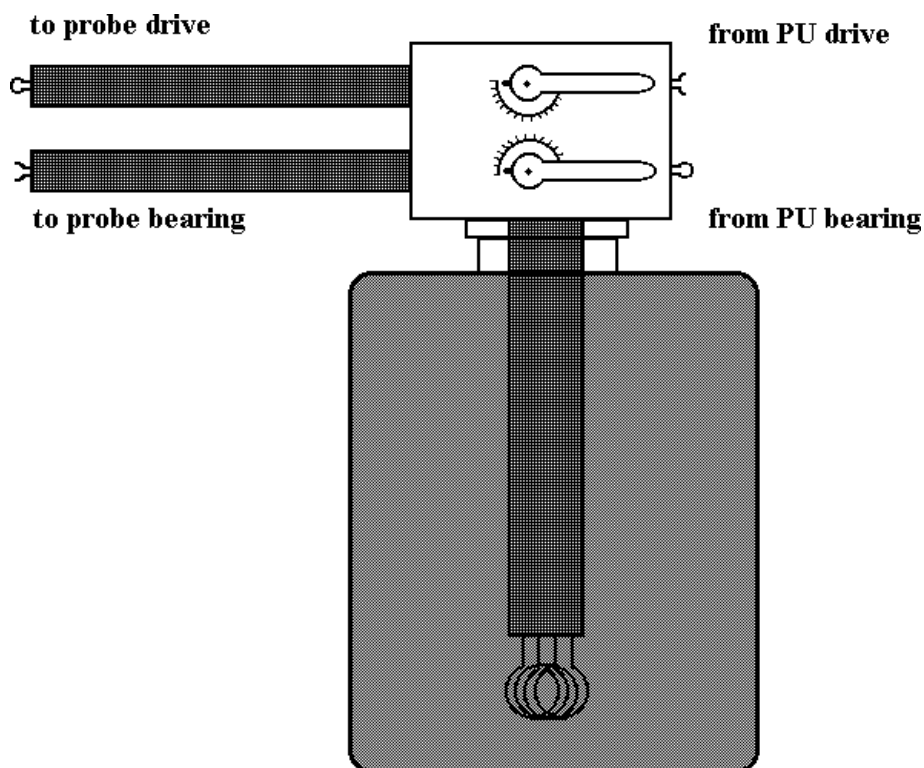

Double double turn loop for HT MAS probes and VTN MAS probes modified for drive gas cooling

Standard setup for different probes

2.5.5

The standard setup for the following probes is described:

- 1H/19F wideline probes, X-BB-wideline probes, stationary CP probes, diffusion probes (identical setup)
- MAS-VTN probes
- MAS-WVT probes
- MAS-VTN probes modified for drive gas cooling
- MAS-HT probes

In general, the setup for high temperature experiments is identical to the setup for ambient temperature experiments except that for temperatures above 200 C, nitrogen must be used instead of compressed air to prevent coil oxidation.

VT connections for non spinning probes.

New non spinning solids probes have a temperature range of up to 400 C. At temperatures between 300 and 400 C, the glass exhaust tube HZ 2290 or HZ 2899 (for WB magnets up to 400 Mhz or 500 MHz) must be used, however for frequent use of temperatures between 100-200 C it is recommended as well. It serves to exhaust the hot temperature control gas to the magnet top without heating up the shim system upper part. For low temperature operation, usually the nitrogen evaporation system is used. However, the MAS-heat exchanger, if available, can

also be used if very stable low temperatures are required. In that case, the VT gas must be dry nitrogen.

Figure 2.25. Vt Connections For Non-Spinning Probes

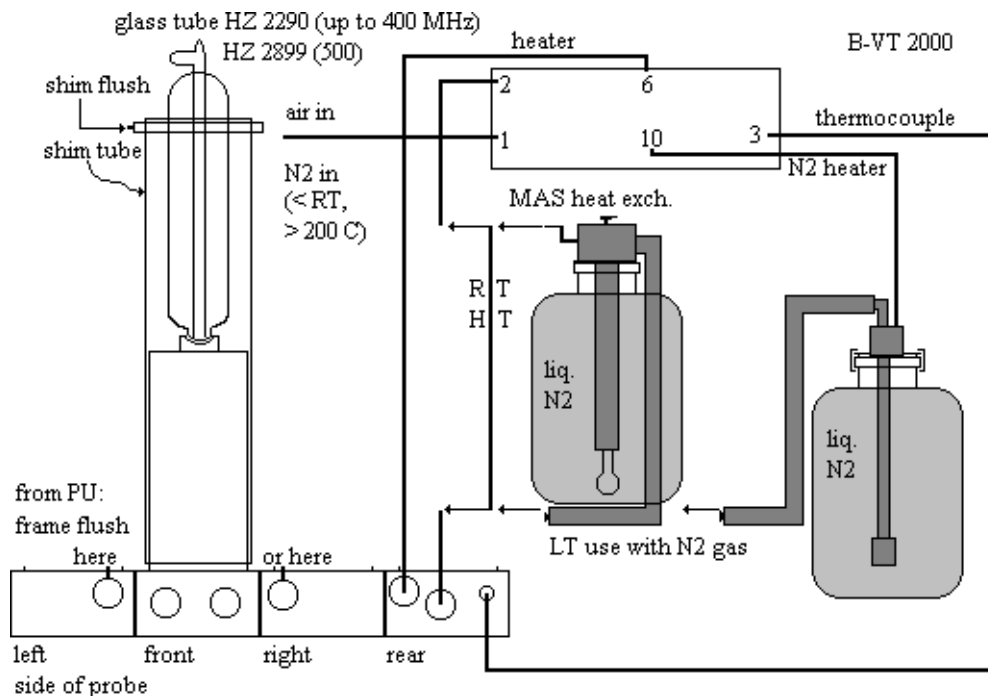

VT and pneumatic connections for spinning probes of standard

VTN design. For RT and HT operation, the bearing gas socket is connected to the probe bearing dewar directly. If a high temperature rotor transfer system is available, the flush line for the transfer system should be connected in parallel to the probe frame flush. Temperatures above 150 C are not allowed. For low temperature operation, the bearing gas outlet socket is connected to the heat exchanger ball connection, and the insulated transfer line to the probe dewar. The drive gas loop of a double heat exchanger is not used. Older heat exchangers with switchable loop lengths require suitable adaptors and the use of the additional -10 and -120 PU bearing outlets.

Figure 2.26. VT and Pneumatic Connections for Spinning Probes - VTN Design

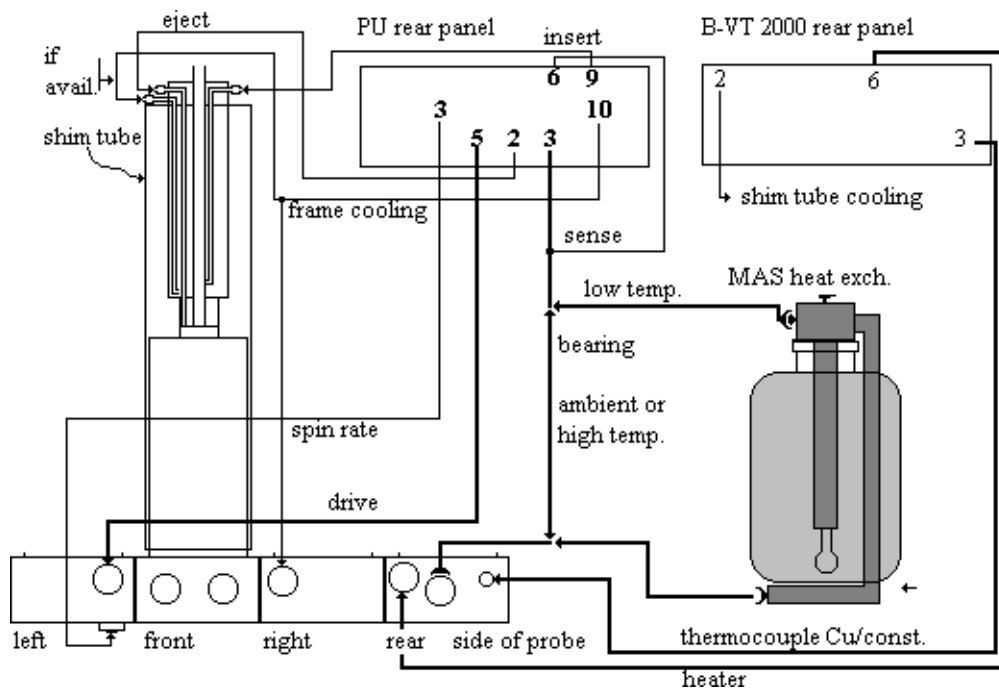

VT and pneumatic connections of spinning probes, WVT design

In general, the connections are like for VTN probes, but the temperature indication is different. The WVT probes have two built-in thermocouples, one for regulation inserted into the bearing gas inlet (chromel-constantane type), TC2, that is connected to the B-VT 2000 triple connector 4. The B-VT 2000 must be configured for appropriate temperature indication! The other thermocouple TC1 is connected either to another B-VT 1000 or 2000 or an additional temperature meter set for copper-constantane sensors. This thermocouple reads the stator outlet temperature. The actual sample temperature is usually closer to the outlet temperature, but always in between both readings. A calibration via a suitable solid NMR sample is required for all probes.

Figure 2.27. VT and Pneumatic Connections of Spinning Probes - WVT Design

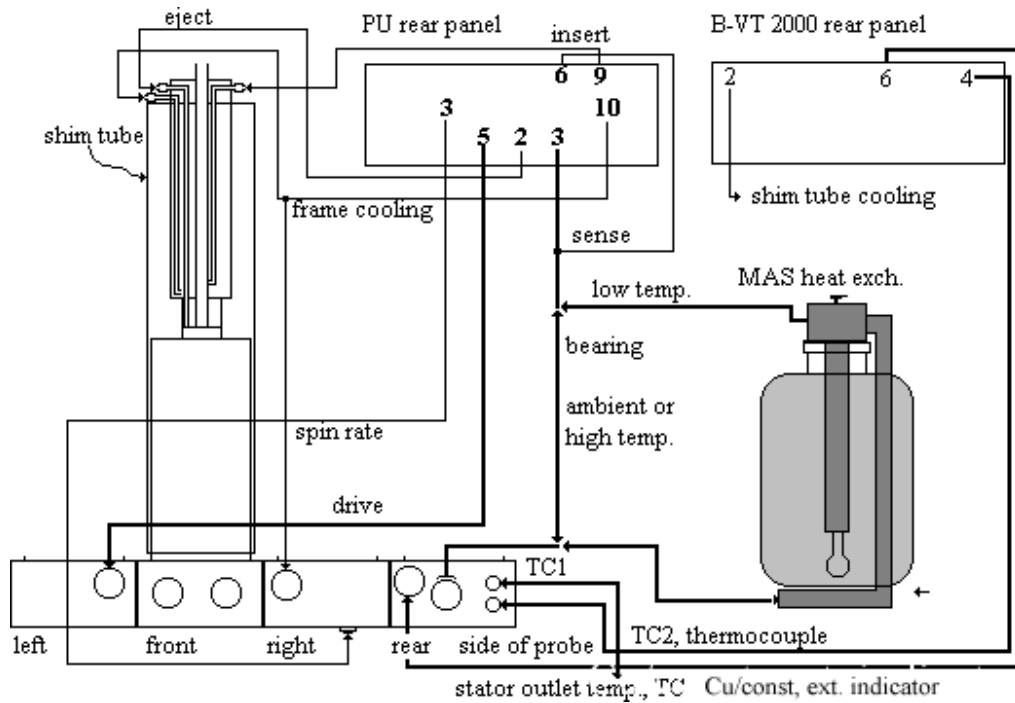

VT and pneumatic connections for VTN probes modified for drive gas cooling.

Here the standard VTN probe is modified to make the drive gas line coolable (standard VTN probe drive lines will leak with cold drive gas). The drive gas heat exchanger is inserted between probe and drive gas outlet.

Figure 2.28. VT and Pneumatic Connections for VTN Probes

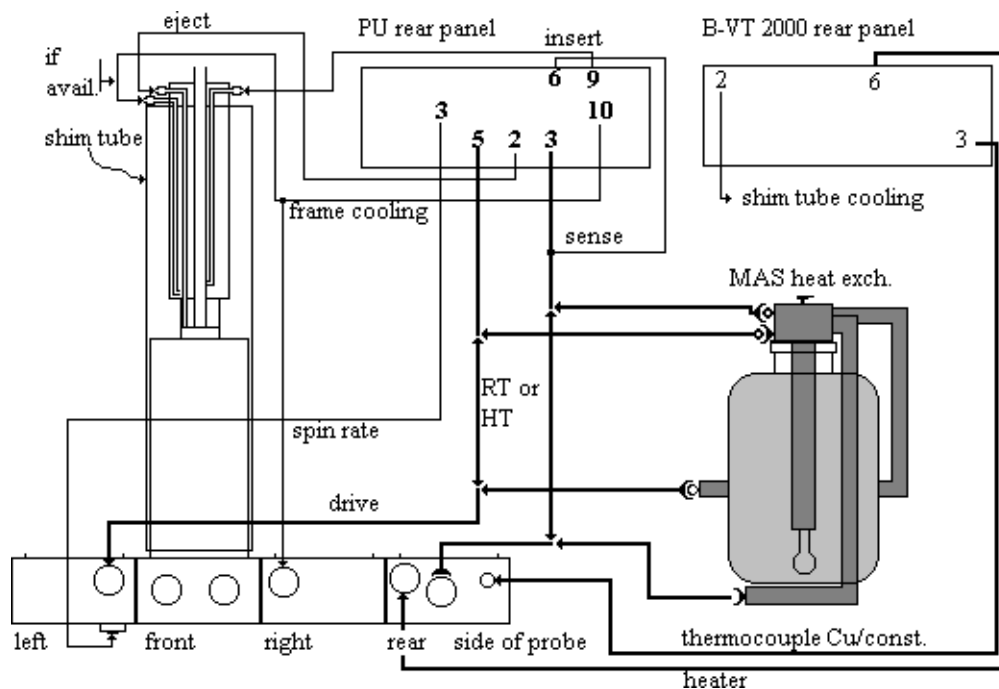

VT and pneumatic connections for MAS HT probes.

The same double line heat exchanger is used as for modified VTN probes. In these probes, the drive gas ball and socket connector is at the probe front plate between the RF BNC connectors. For high temperature operation, the drive gas heater must be inserted at the probe. It is operated by the slave heater unit, connected to the master B-VT 2000 with the „retransmission cable“ as indicated. N.B.: the master unit must contain a slave control board. Drive gas temperature is always set to bearing gas temperature + 70 C. The temperature sensor in the drive heater is of chromel-alumel type since very high temperatures are reached there. The total heat dissipation at maximum temperature is about 1 kW, so efficient shim system and probe cooling is essential!

Figure 2.29. VT and Pneumatic Connections for MAS HT Probes

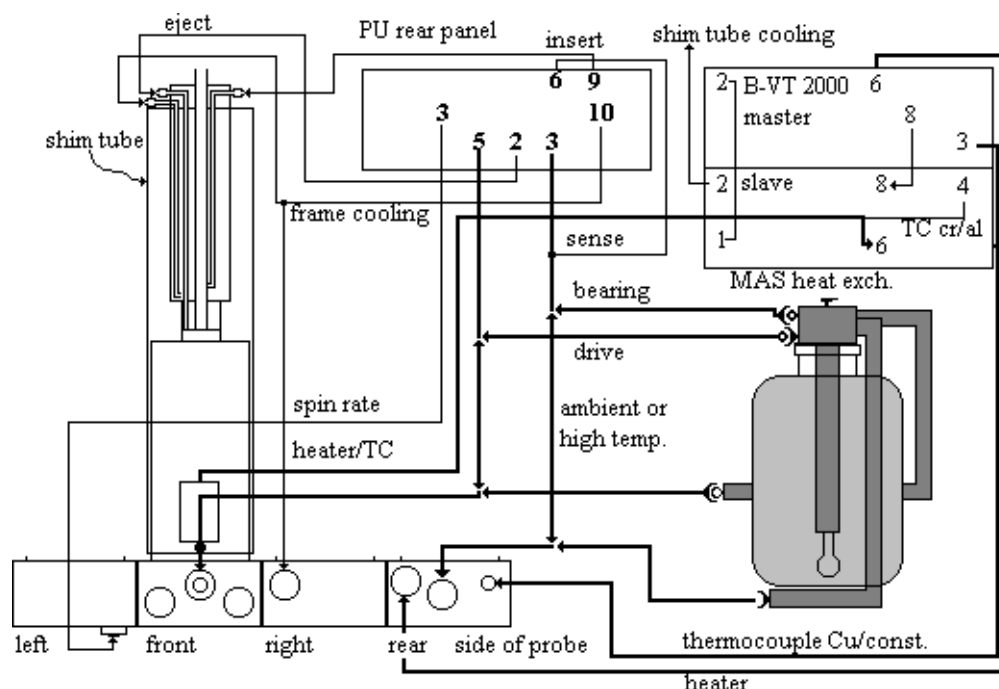

Operation of the MAS Pneumatic Unit, PU

2.6

Configuration

2.6.1

(Please refer also to section I.8, software descriptions)

If the unit is to be connected to the CCU directly (if a HPCU is not available), the RS 232 port and some basic settings must be configured with cfmas.

When the configuration „cfmas“ is started from UXNMR a dialogue box is initiated and you should answer the questions as follows:

:

Which device is used for MAS unit?	tty07(standard port)
Minimum main pressure?	4000
Insert air on time	10
Eject air on time	10
Probe diameter (W >= 89 N < 89)	W or N for SB magnets
Using MAS in automation	Y

This information will be stored in the file `mas` in the directory `/u/conf/instr/<spectrometer>/rs232_device`. The settings of probe diameter and of eject and insert air on time can be changed in the „mas“ menu described below, but for permanent change of the default settings the „cfmas“ command has to be repeated and the parameters be changed according to the personal wishes.

Preparation of the communication with the pneumatic unit

2.6.2

The pneumatic unit can be fully operated from UXNMR. To enable the communication the MAS unit has to run in remote mode, which can be selected by pressing the corresponding button at the key pad on the front panel. To make sure that the MAS unit goes automatically into this mode when it is switched on, press the „Reset“ button after having selected the „Remote“ mode. Now switch the unit off and then on again. The red LED for the remote mode must be lit.

- ⇒ Important note: Only switch the MAS unit on when the main pressure is above 4 bar, because this is used for internal calibration of the stepper motor drive valves.

Figure 2.30. MAS Pneumatic Unit Control

MAS Pneumatic Unit Control					
MAS Firmware Version:	941205				
Probe Setup Filename:	<input type="text"/>				
Bearing Gas Port:	<input type="text"/>				
Probehead Selection:	Diameter	Probe	Type	Material	User
	<input type="text" value="7 mm"/>	<input type="text" value="BL"/>	<input type="text" value="WB"/>	<input type="text" value="ZrO"/>	
		Demand	Actual	Maximum	
Main Pressure:		<input type="text" value="0"/>	<input type="text" value="8250"/>	<input type="text" value="10000"/>	mbar
Bearing Pressure:		<input type="text" value="0"/>	<input type="text" value="1600"/>	<input type="text" value="2000"/>	mbar
Drive Pressure:		<input type="text" value="0"/>	<input type="text" value="460"/>	<input type="text" value="2000"/>	mbar
Spin Rate:		<input type="text" value="3506"/>	<input type="text" value="3506"/>	<input type="text" value="5000"/>	Hz
Setting Mode:	<input type="text" value="Auto"/>				
Spinning:	<input type="text" value="On"/>	Insert AirTime:	<input type="text" value="10"/>	sec	<input type="text" value="Insert Sample"/>
Spin. Locked	<input type="text" value="Yes"/>	Eject Air Time:	<input type="text" value="10"/>	sec	<input type="text" value="Eject Sample"/>
StartupProgram	<input type="text" value="0"/>				
<input type="text" value="Save"/>	<input type="text"/>	<input type="text"/>	<input type="text" value="ContinuousUpdate"/>	<input type="text" value="Edit"/>	<input type="text" value="List"/>
	<input type="text" value="Cancel"/>				

The communication with the MAS unit is initiated using the command „mas“, which will display the window shown above. The actual status setting of the MAS unit is read and displayed in the line „Probehead Selection:“ You can select the appropriate sample diameter (4 and 7 mm are supported), the probe type (BL for 4 mm rotor diameter and BL or DB for 7 mm). If you are in doubt which probe you have, please refer to the red label at the front panel of your MAS probe. The probe and its diameter are used to define the program that is used when you start up a rotor in the automatic mode. Since the acceleration of various rotors is quite different, optimised programs for the start up procedures of each type of probe must be used.

For the item „Type“ in the line indicated „Probehead Selection“ you have to define SB for a standard bore probe or WB for a wide bore probe. This selection is important to enable the pneumatic switch between vertical and magic angle position of the stator in the standard bore probes and which is not used for wide bore probes. Finally the item „Material“ defines the maximum possible spinning speed by selecting either ZrO (current values are 4 mm: 15 kHz, 7 mm: 7 kHz) or SiN (4 mm: 17 kHz, 7 mm: 7 kHz). This parameter will not be displayed in this window but is loaded internally into the MAS unit.

If you have different types of probes it is probably a good idea to „Save“ the setting in a „Probe Setup File“. Once you clicked the „Save“ button, the already existing setup files will be displayed. You can overwrite an existing file or enter a new file name. Make sure that all users have write permission for the directory /u/exp/stan/nmr/lists/mas. For later use you can select this setup file in the top row of the menu, and the settings contained in this file will be loaded into the MAS unit.

Values for main pressure, bearing pressure, drive pressure, and spin rate are given underneath the probehead selection. The right most column gives the maximum values for all of these parameters. They can be altered interactively but their

use is currently not implemented. The values in the column indicated as „Actual“ cannot be altered interactively, but these values are updated when the „mas“ menu is initiated and also when the „Continuous Update“ button is activated. In the „Demand“ column only the value for the spin rate is of interest. Here the value for the desired spin rate is entered. Also values for the bearing pressure and drive pressure can be entered. This will only be active in the manual mode, which needs to be used only for samples which are difficult to spin. In that case, one would normally spin the sample up in the local manual mode using the PU key-pads, because the update of displayed data is quicker.

Operation of the pneumatic unit

2.6.3

Sample insertion and start of spinning

After having done all hardware connections according to the probe manuals, sample insertion and ejection, spin up and down can be handled by calling up the above menu with the UXNMR command „mas“.

The first step is to either select an existing probe setup file, or make sure that the correct „Probehead Selection“ is made. Make sure that all hardware connections are made according to the probe manual. With the standard bore probes you then click the „Eject Sample“ button which will switch the stator to the vertical position and after a few seconds switch on the eject air for 10s. A rotor which might be inside the probe will be ejected. When the eject air is switched off again the rotor for the next experiment can be dropped into the MAS transfer system. Clicking the „Insert Sample“ button will switch the stator to the magic angle position after 10s. The rotor must be dropped into the probe before activating this button because otherwise it could happen that the stator is flipped just when the rotor is between the top opening of the probe and top part of the stator. In this case the rotor as well as the stator including the coil will be damaged.

With wide bore probes, the stator remains at the magic angle during sample change. Problems will occur if a spinner is inserted if another spinner is already in the probe. It is recommended, that an eject is done after the probe was installed to make sure that there is no spinner already in the probe. If the eject system cap is closed all the way, there may not be enough flow of eject gas in order to push the spinner around the corner inside the probe eject channel. Therefore, for ejection this cap should be somewhat open. If a spinner does not eject, press insert and eject again. N.B.: when using a MAS sample change, insert will load another spinner in addition, so there the sample must be ejected by pressing eject several times if necessary. When the new sample is loaded, insert must be pressed in order to push the spinner into the stator. In wide bore probes, the spinner may drop down only to the stator front bearing, not all the way in since it does not fall down straight as in the case of SB probes with vertically tilted stator.

You can now enter the desired spinning speed at the position of „Spin Rate“ „Demand“. After clicking spinning to „on“ you can activate the „Continuous Update“ button and the actual setting of the bearing and drive pressures as well as the actual spinning speed will be displayed updating these values every 10s. After the desired spinning speed is reached and stable within (4 Hz for 4s, the status of the „Spin. Locked“ signal will be set to „Yes“ on this display. Simultaneously the red LED „Spin Lock“ at the MAS unit front panel will be lit. Now the system is ready to tune the probe and run the acquisition. With the „Cancel“ button the „mas“ menu can be exited. It is recommended that automatic spinning is started within MAS, not with masg because then the spin up can be monitored and a failure will be detected. If the spin rate does not increase as expected, turn spinning off again by

Standard Setup Procedures

clicking spinning off. Do not switch the unit to local manual mode at the PU keypad before the spinner has halted and the MAS menu has been cancelled, because the unit may hang up, not reacting to the stop button. Pressing clear in such a case should reset the unit.

In standard bore probes, spinning standard samples (worn out probes, DB probes, and unusual samples will show a different behavior), the spin rate/drive pressure correlation should be approximately as given in the following table. Please note that probe and sample dependant variations are quite large, especially during the spin up period. Wide bore probes behave similar with somewhat lower drive pressure. Longer probes (500 Mhz WB, 600 and 750 MHz SB probes will require somewhat higher drive pressure due to longer tubes and higher flow restrictions.

Table 2.1. PH MAS200-400SB BL4

PB(mbar)	PD(mbar)	f(kHz)
2300	280	4
2400	370	5
2500	510	6
2800	790	8
3000	1180	10
3000	1820	13
3000	2280	15

Table 2.2. PH MAS200-400SB BL7

PB(mbar)	PD(mbar)	f(kHz)
1500	480	3
2000	740	4
2500	1070	5
3000	1380	6
3000	1820	7

Changing the speed while spinning is on

When the spinning speed has to be changed while the rotor is already spinning to ways of doing that are possible. The first way is to call up „mas“ and enter the new desired spinning speed. By activating „Continuous Update“ the change of the pressure settings and the spinning speed can be followed. A second possibility is to enter the new spin rate directly using the command „masr“. When this command is typed the actual spin rate of the rotor at this instant is displayed and can be confirmed with <return> or changed by typing the new value. Notice that the complete figure has to be entered, e.g. 10000. Entering 10e3, 1e4, or 1k will always be translated into 10. On the front panel of the MAS unit you can see that the new

value is displayed and that drive pressure and probably also bearing pressure are readjusted for the new spinning speed.

Stopping sample spinning

To stop sample spinning again two possibilities exist to do so. The first is to call up „mas“ and set „Spinning:“ to off. You will notice that the mas menu comes up with this flag set to off already, but in fact you have click on it to set it to off (again). An alternative way is to type the command „mash“ in UXNMR. Both ways will initiate the sample stopping procedure programmed in the MAS unit.

For sample ejection and insertion separate commands are also available which will avoid going into the „mas“ menu: „mase“ for ejection and „masi“ for insertion. There is also a command to start the spinning („masg“) but at the moment it is not recommended to use this because in a case where the rotor does not spin up properly, e.g. due to unbalanced packing, there is no possibility of interfering with unit to stop the start up procedure. This can only be done by starting the spinning from the „mas“ menu. The reason is that the command „masg“ is used in automation in conjunction with the MAS sample changer. Therefore the UXNMR program waits after a „masg“ command for the Spin Lock signal from the MAS unit to continue the automation sequence. That is why the RS232 line is busy and there is no possibility to interfere. In the automation on the other hand the software recognizes a case where a rotor does spin up properly and halts it before a next try or going to the next sample.

Caveats:

2.6.4

The current pneumatic firmware (delivered up to 1995) has some flaws which should be kept in mind.

- the start-up bearing pressure for 4 mm probes is set to 2000 mbar. This will not spin up quite a number of samples. The start-up pressure for 7 mm BL probes is 250 mbar, which will spin the sample up easily, but then the spinner may speed up too fast and reach illegal speeds with the bearing pressure still too low. It is recommended to set the bearing pressure start to 750 mbar for 4 mm probes, and 500 mbar for 7 mm BL probes. This is done in the following way:

Set the unit to local automatic mode. Then press bearing and use the up/down buttons to set the desired „bearing pressure start“. If no changes are made, the display switches back to the standard display after a few seconds. This setting must be repeated after the unit was switched off or reset.

- when maximum spin rates were set in manual mode with bearing pressures higher than 3 bars, pressing stop will first set the bearing pressure to 3 bars. With heavy samples, this may induce spinner crashes. In that case, reduce the spin rate manually first by reducing the drive pressure to a safe level before pressing stop.

- when the spinner is spun to higher speeds than allowed in the automatic mode, setting the mode back to automatic, the demand spin rate will not change and therefore the bearing pressure will remain even if higher than 3 bars. This is fine until the spin rate is changed by 100 Hz or more. Then the bearing pressure will be readjusted to the maximum of 3 bars, eventually with bad consequences.

- when the probe is operated at low temperatures it may be desirable to keep the bearing pressure constantly at a higher level than automatically adjusted. In that case, the manual mode must be used.

Tuning the Probe

2.7

There are several procedures for probe tuning. The standard procedure uses the built in wobble feature. Other procedures tune on the RF pulse reflected by the probe, and on the NMR signal directly. Tuning on the reflected pulse requires a directional coupler suitable for the NMR frequency used and for the power level used. Tuning on the NMR sample requires a suitable sample giving a strong signal with short repetition rates. Sequences suitable to do this are described in section V, CRAMPS experiments. However, similar procedures can be used for tuning of wideline probes or CP-MAS probes if perfect probe tuning is required. The standard tuning procedure for all experiments is the WOBB. The appropriate preamplifier is connected to the probe. Typing WOBB and observing the acquisition window shows the response of the probe over \pm WBSW/2. The tuning is achieved in the following way:

The SE-451 sends out a weak (about 20 mV) NMR frequency RF swept over a range given by WBSW in the F1 synthesizer. This goes to the preamplifier tune input, from where it is routed to the currently specified observe preamplifier. In the preamplifier, there is additional attenuation and a directional coupler that allows to route the RF into the probe and amplify the reflected voltage via the preamplifier. The reflected signal is amplified and routed back to the receiver where it is amplified and quad-detected. The probe response is basically two phase modulated quadrature signals which after a magnitude calculation show the frequency dependant probe response as an absorption curve. In order to get a 50 Ohm reference, the WOBB routine first measures the frequency response of a built-in 50 Ohm resistance, or, if wobb ext50 is used, an external 50 Ohm reference resistor. Since the impedance of this reference has no frequency dependant response, a 50 Ohm base-line can be found which is placed at the display bottom. Probe tuning now means to set the probe response absorption curve to the center tuning frequency indicated by a reference line in the middle of the screen using the tune adjustment of the probe, and using the matching adjustment to pull the response minimum down to the reference line at the bottom.

There are two caveats:

- for precise tuning, the wobble width WBSW should not exceed 5 MHz
- if the receiver reference is changed while the wobble procedure goes on, the reference signal is changed and the 50 Ohm calibration is incorrect.

The routine will automatically compensate for differences in the output level and amplification at different frequency by setting the receiver gain appropriately during the calibration routine. If the receiver DC offset is large or comparable to the received signal, no appropriate RG is found and WOBB will not work. So the DC offset must be adjusted decently before WOBB is started (for FADC, this must be done on the SE-451 first setting the DC for the „slow“ ADC, then at the FADC board using an extender to also set it for the FADC. This adjustment is part of the installation procedure. Since the detected WOBB signal is strong compared to usual NMR signals, the DC offset must be quite a bit off to cause problems during WOBB.

Figure 2.31. WOBB display of a detuned probe

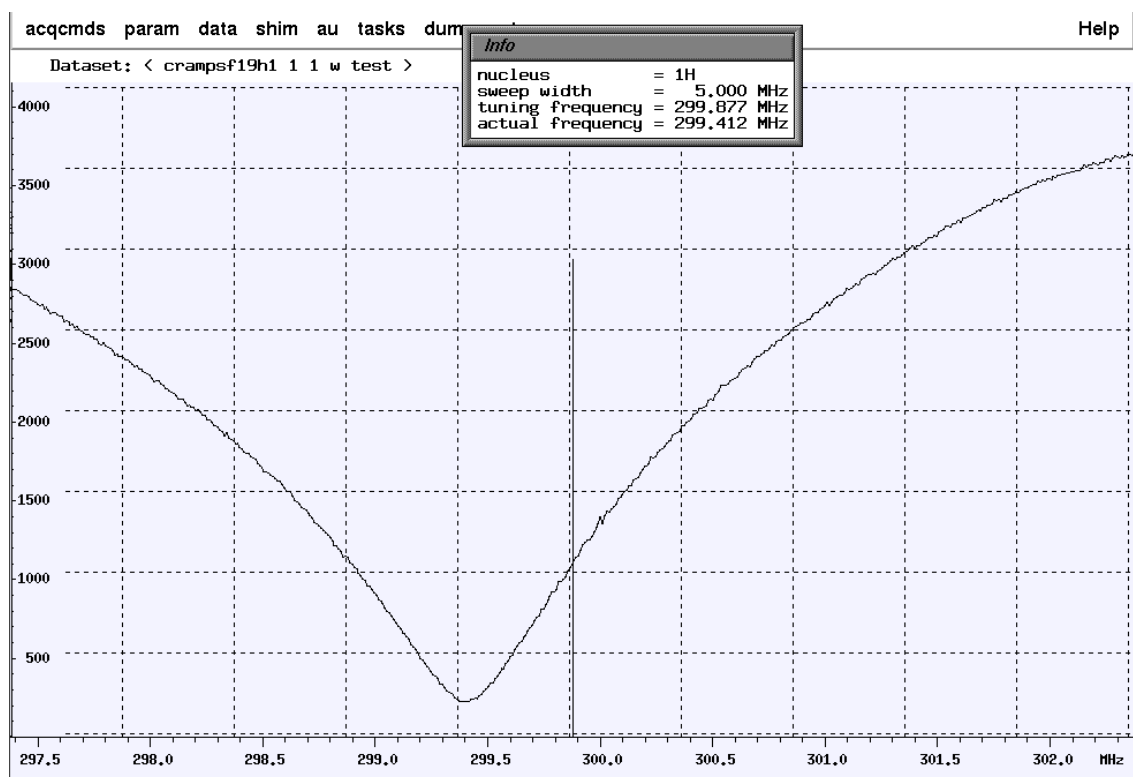

Figure 2.32. WOBB display of a properly tuned probe

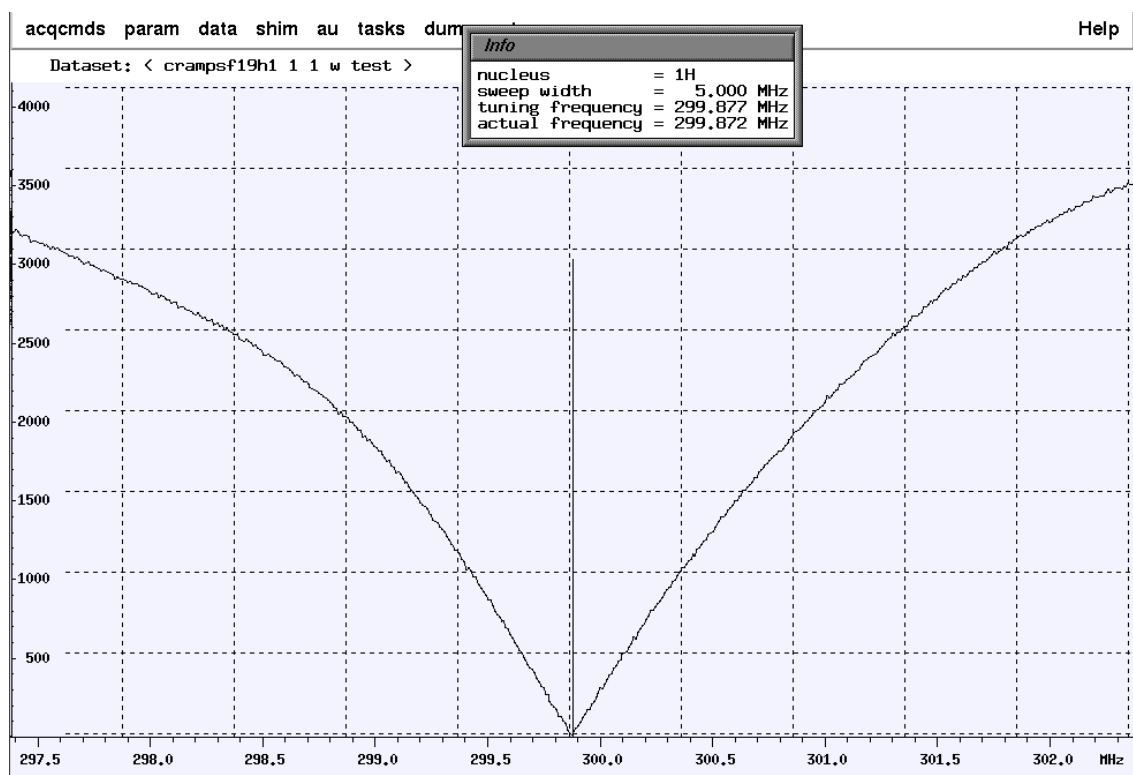
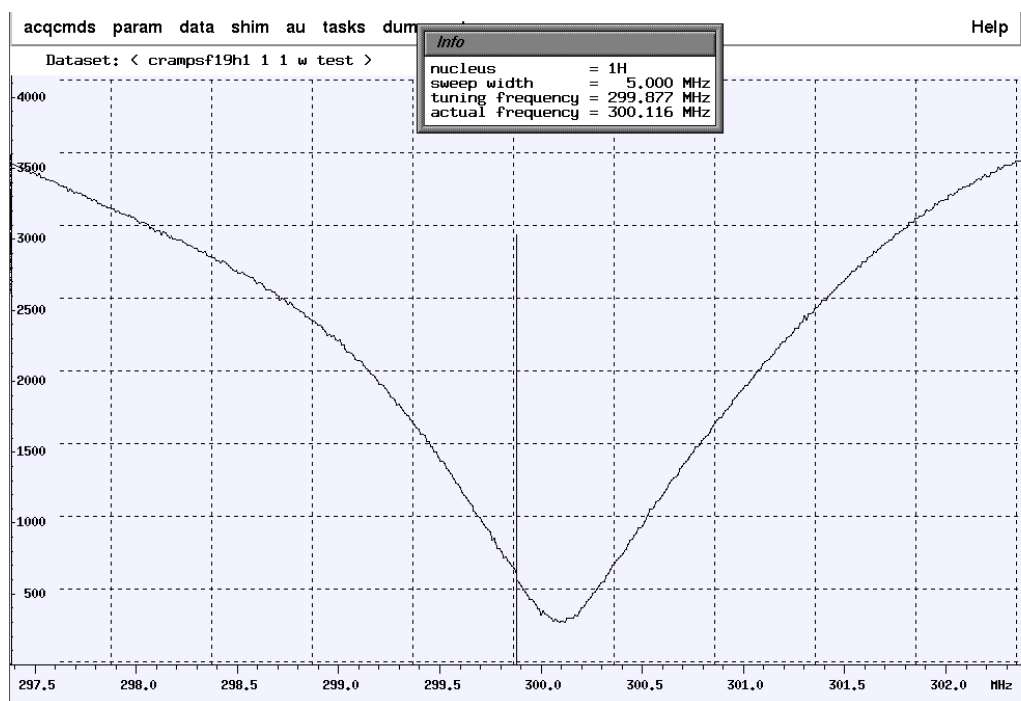

Figure 2.33. WOBB display of a low Q probe, tuned with a setup sequence



Tuning and matching a probe with WOBB will set the probe tuning very well for high Q probes (CP and high resolution probes), but it may be off for low Q probes; it also may not be appropriate if appropriate excitation is more important than high sensitivity detection.

This is for the following reasons:

- The weak CW signal provides correct tuning for small RF signals like an NMR signal during detection. However, during the pulse the conditions may be slightly different.

- In low Q probes the assumption that at 50 Ohms impedance the power reflection is best does not hold. It does also not hold if the transmitter output impedance is not 50 Ohms, or any component along the transmission line is not matched to 50 Ohms (filters, attenuator, or the preamp multiplexer circuit). In most standard experiments, a slight mismatch will only show in somewhat longer 90 degree pulse widths or less signal to noise. In practice, that means that for shortest possible pulses, the probe should be tuned on an NMR tuning sequence as described in the section about CRAMPS experiments, or by monitoring the reflected pulse envelope pulsing into the probe with a directional coupler inserted between preamp and probe and an oscilloscope. This also allows to check whether the probe can take all the power that is put in or whether it arcs at this power level.

Wherever minimum pulse glitch and maximum excitation bandwidth is required, the performance of the experiment will improve by using such a tuning procedure. Such experiments are generally all multipulse experiments like CRAMPS, solids HETCOR, all experiments with many pi pulses like the pulsed chemical shift/CSA correlation, shift scaling, and also echo experiments with very wide lines. Such a tuning procedure will also usually yield shorter probe deadtime. If a probe is adjusted with a CRAMPS procedure or with a directional coupler, the WOBB response will usually be shifted to higher frequency and an off 50 Ohm match. In such a case, the response signal of WOBB should be remembered and after sample change, only the

tune adjustment be moved to get the same probe response (in low Q probes, the probe response is not very sensitive to sample change anyway).

Tuning a probe with a directional coupler and a scope is done in the following way:

-A directional coupler of suitable frequency range (see the following section) is inserted between preamp and probe. The scope should be triggered from the pulse program (nmr5 13 BNC at power router connected to the external trigger input of the scope). The pulse program should execute pulses at the desired pulse length and power level, and should have a `#include <trigg.incl>` and a `trigg` line before the pulse. At 100 msec recycle rate, pulses are transmitted to the probe (transmitter perfectly tuned for best pulse shape into a 50 Ohm dummy load). The reflected power is monitored on the scope input from the directional coupler output that is next to the power cable to the probe.

The drawing shows the reflected RF envelope with bad and good probe tuning. Note that if the pulse RF is not pure, the undesired frequency will always be reflected and the shape will always look like the probe was badly tuned. In that case, a band pass filter of the desired frequency should be inserted between directional coupler and scope. This will allow to tune for the desired frequency. The experiment will hardly be affected if the pulse contains RF 10 MHz or more away, but a low frequency modulation (ripple) will hurt.

Figure 2.34. Reflected RF Envelope

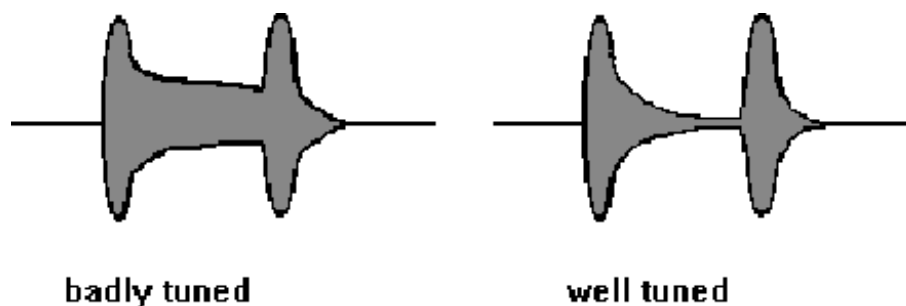

Probe tuning should be checked after every sample change in the following cases where the dielectric properties of the sample change noticeably, especially if a high Q probe (CP, CP-MAS, 1H/19F wideline, X-wideline probe with high Q plug-in) is used:

- spinner material is changed from ZrO₂ to SiN
- or samples have different liquid content
- or conductive samples are inserted. In this case, tuning may be impossible.

If a probe shows no more tuning response in WOBB, remove such a sample again and insert it gradually, following the probe tuning with WOBB.

Tube amplifiers contain output or input-and output circuits which transform the impedance to higher values than 50 Ohms which are fairly narrow-banded. Therefore they require tuning for frequency changes over more than 3 MHz in order to

maintain full power. This is done manually or automatically by the HPCU microprocessor. The tuning procedure involves pulsing into a 50 Ohm load, preferably a dummy load of high power capacity. If a dummy load is not available, a tuned high power probe may be used if precautions are taken not to overstress the probe when the transmitter is tuned. The pulse output is monitored with an oscilloscope or at the HPCU keypad power indicator. Then the tuning controls at the keypad are adjusted for maximum power and best pulse shape. The HPCU microprocessor will do this automatically, when AUTO TUNE X or TUNE H is pressed after fast pulsing with more 10 usec pulses is started. Typical conditions are:

- 100 msec recycle rate (d1)
- 10-50 usec pulses (p1)
- pulse program zgadc or tx4c or txttest
- transmitter gain no more than 500 units on the gain adjustment.

The HPCU auto tune procedure will increase the gain until a forward power indication is visible, then tune over the full range and find the best position counting the number of steps over which the stepper motor turning the tuning adjustment has to move, then setting the best position. If the transmitter power exceeds a safe voltage, the transmitter gain is reduced. After the tuning procedure is done, the gain is reset to the preset value, so this value should not be more than 500 units if a high power probe is used as load.

The tuning values found should be stored to the data file with gethpcu. Please note that proton and X-transmitter values are always stored simultaneously.

With AMT, B-LAX and B-LAH 1000 transmitters, tuning is not required

Useful Equipment

2.9

High power solids NMR spectroscopy very often requires to use the equipment to the performance limits. Therefore it is useful to have some additional equipment available that allows to adjust, monitor and check the hardware. The most useful equipment includes:

- a. dummy load and attenuator (price: approx. USD 600.-)
- b. directional coupler(s) (price: approx. USD 200-600)
- c. oscilloscope (price: approx. USD 10 000.-)

The dummy load should be able to handle 100 W of CW power, and should provide a broadband 50 Ohm load with a 30 dB attenuated output. This allows to attenuate >1 kW of pulse power down to a pp voltage than can be observed with an oscilloscope. Be careful to never pulse into the output connector of the load since this will kill the attenuator and produce incorrect attenuation. 30 dB corresponds to a reduction of RF ppVoltage by a factor of 31.6 (for ease of calculation, another 10 dB attenuator may be added at the load output to give a 100fold attenuation in voltage). The power output is calculated as $(V_{pp})^2/400$. A pp voltage of 632 V corresponds to 1 kW of power. This corresponds to 6.32 V measured with 40 dB attenuation or 20 V pp measured with 30 dB attenuation.

The scope input impedance must be set to 50 Ohms in order to get correct voltages.

Figure 2.35. Dummy Load Attenuator

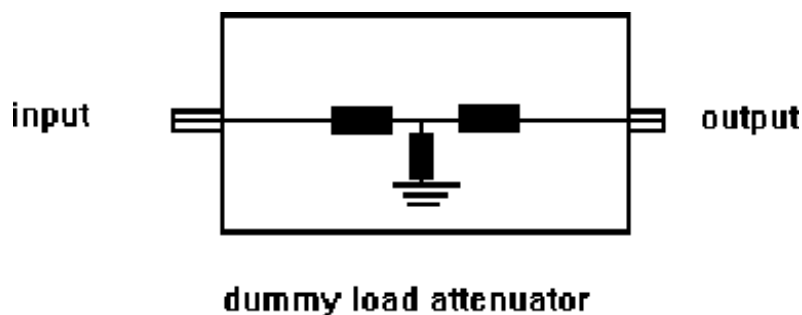

The directional coupler should cover the required frequency range, which may be a problem at the low end (below 30 MHz). It must have a precise 50 Ohm impedance and two outputs for forward and reflected voltage. It is inserted between preamplifier and probe and should stay in place after probe tuning. It must be able to handle a power throughput of > 1 kW which means it must not attenuate the RF pulse (or NMR- signal). Directional couplers as used in high resolution for homo-decoupling or in imaging to combine two transmitters are not suitable.

Figure 2.36. Directional Coupler

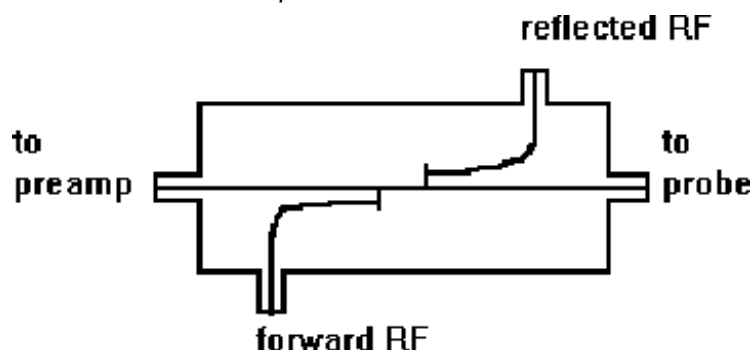

The oscilloscope should cover the highest possible NMR frequency at max. 3-6 dB attenuation. A good 300 MHz oscilloscope will be usable up to 400 MHz. It should have 2 channels with 50 Ohm/1 kOhm inputs and an external trigger channel. Test the scope under the following conditions:

set the highest frequency on your spectrometer (usually proton frequency), pulse with 2 usec pulses with 100 msec recycle rate, and trigger on the RF pulse. It should be possible to see that pulse clearly when the room illumination is dimmed, and the pulse display should be easily triggered and stable.

Nice, but not essential features are delayed trigger, indication of time, frequency and voltage on the screen, and built in frequency counter. Tektronix scopes like the 2465 or similar scopes are adequate.

CP-MAS Experiments with WB Probes

3

Necessary equipment

3.1

Hardware:

3.1.1

Instrument with WB magnet, either with B-LAX/B-LAH transmitters(LP) or with HP-rack (HP), suitable preamplifiers (HPHPPr in the case of HP amplifiers), sample transfer tube, cable and tube set, WB probe with 3 spinners and sample preparation tools. Set of Teflon spacers, K 1092 for 7 mm probes.

Site requirements:

3.1.2

The site requirements with respect to compressed gas supply are the following:

- Minimum main pressure 5 bar, better 6 bar optimum 8 bar
- Minimum compressor capacity 220l/min. with 100% duty cycle, taking into account compressor efficiency (usually 70%).

This will allow 5 kHz spin rate in a 7 mm probe. High speed spinning (10 kHz 7 mm, 20 kHz 4 mm requires twice as much flow)

- dew point <-30 C
- no residual oil (100% oil free)

Test samples:

3.1.3

-glycine, finely powdered (warning: glycine may have more than 1 crystal modification, easily seen as additional peaks around 174 ppm. Use pure glycine which has less than 5% of any additional peak).

-adamantane, finely powdered

-KBr, finely powdered

-distilled water

-see section 5. for multinuclear samples

Hardware setup

3.2

Follow the hardware setup procedure as described in chapter III. Decoupling RF should not be transmitted via any HPPr-preamplifier.

Exception: High power ¹⁹F/¹H/³H preamplifiers if the experiment requires this. HR preamplifiers will not survive full decoupling power over extended periods of time.

Experiment setup

3.3

The following procedure should be applied for initial setups. Consecutive setups may omit the steps that are not underlined>. Software commands are available in UXNMR versions XWIN-NMR.a.9 or later. Every setup step should be stored as data file after tune-up. The following data set names are proposed as a convention:

- H1HP 1 1 for proton transmitter tuning
- C13HP 11 for X-transmitter tuning for C-13 frequency
- N15HP 1 1, P31HP 1 1 and Si29HP 1 1 for other X-frequencies
- H1shape 1 1 for the shape pulse setup,
- Shimmas 1 1 for probe shimming on water
- KBr 1 1 for angle adjustment on KBr
- Adamdec 1 1 for adamantane with hp decoupling
- Adamcp 1 1 for adamantane CP
- Adamres 1 1 for adamantane resolution test
- Glyangle 1 1 for angle and HH adjustment on glycine with narrow sweep width
- Glyvacp 1 1 for VACP setup
- Glyvacp 2 1 for glycine acquisition with vacp
- Glycine4 1 1 or glycine7 1 1 for glycine test spectrum with cp

Make sure to store HPCU parameters into every data set with gethpcu.

Transmitter setup (tube amplifiers only):

3.3.1

- Set data set H1HP 1 1
- Set powmod =high
- Switch HP amplifiers on in EDASP, select preamplifiers
- Type rackpow
- Wait for HV indication to come on (HPCU-keypad)
- Tune proton transmitter with EDASP set for proton observation, pulse program zgadc, set drive power level pl1 to appropriate value as found during installation, Find gain setting or drive power level (cavity) which delivers

about 100W (300 MHz or higher), 50 W (200 MHz), 30 W (100 MHz). Store HPCU parameters to data set with gethpcu.

To provide for variable amplitude CP,

- Set data set H1shape 1 1, load pulse program shapetest, generate a triangular pulse shape with SHAPE and find a value for sp0 that provides best linear transmitter response (class C tube amplifier). SHAPE Procedure is given below in section VACP. Store setup parameters with gethpcu.
- Set data set to C13HP 1 1, set powmod=high, in EDASP: select HP-transmitters, select HPHP X-BB preamp, type rackpow, tune transmitter in a similar way, set pl1 to appropriate value. Find gain position that delivers 200 W (400 MHz instruments or higher, 150 W, for 300, 100W for 200 or 100 MHz instruments.) Store with gethpcu.

Probe preshimming:

3.3.2

- Set data set shimmas 1 1
- Fill an empty spinner with distilled water, make sure it is completely full. Preferably use a cap with hole to let excess water out.
- Set up for proton observation, using the appropriate preamplifier and pulse program zg. Set transmitter power to about 100W. (50W or 30 W for lower fields). Shim on proton FID of water with 1u pulses, 1s d1 with 125 kHz sw, td 4k. Shim for monoexponential decay from full amplitude to min. 30%. Save shims. With o1=0 change BSMS field until FID is exactly on resonance.

Angle adjustment:

3.3.3

- Set data set kbr 1 1
- Prepare a spinner with finely powdered KBr. 4mm spinners may be filled completely, 7 mm spinners should have the KBr packed between 2 Teflon spacers to facilitate spinning.
- Insert the KBr spinner and spin at 5 kHz
- Setup for Br-79 observation with transmitter power set as above (HP transmitter need not be retuned). Observe Br-79 FID with 50m d1, 2u p1, sw 125e3, aq 8 msec. Accumulate 128 scans, ft and set o1 on the center peak. Pulse in gs mode and change receiver phase to get most of the signal in one receiver channel. Tune the angle until the sideband „spikes“ riding on top of the signal extend to the end of the FID after 128 scans. Use AU program angle or angle set to repeatedly acquire KBr FID and display FID or spectrum.

Make sure the pattern gets worse turning to either side. See fig. [3.1](#), [3.2](#) for Br-79 FID before and after angle adjustment.

C-13 observe and shimming:

3.3.4

- Set data set to adamdec 1 1

- Insert spinner filled with finely powdered adamantane. Spin at 2-2.5 kHz. Tune probe proton channel, then carbon channel. Set EDASP for C-13 observation and proton decoupling), powmod=high, both HP- transmitters on. Save and type rackpow. Set C-13 power to 200 W, proton power to 100 W with appropriate drive power levels as found before (lower power for 200/100 MHz instruments). Load pulse program hpdec. Find adamantane carbon spectrum at sw 50 kHz. Set sw 20e3, aq 100 msec, set C-13 90 degree pulse width to 5-6 usec adjusting C-13 power. Shim on adamantane FID for line widths <6 Hz (7mm) or <10 Hz (4mm in 400 MHz or higher instruments). Aq must be 200 ms 400ms to show resolution <10 Hz or <5 Hz. Increase d1 to 20*aq for long decoupling times. Store with gethpcu.

Adjustment of Hartmann-Hahn condition for CP

3.3.5

- Set data set to adamcp 1 1
- Load pulse program cp. Set p15=5m, p3=4u, pl1 and pl12 =pl2 as found for given power levels before. Reset aq to 100m.
- Pulse with d1=4s and reduce either C-13 or 1H power to find maximum signal. Then find p3 for smallest signal (proton 180 degree pulse). Reset both power levels to get maximum signal at a proton 90 of p3 = 5u. Improve shims with longer aq if necessary.

⇒ **Make sure that high decoupling power levels are not applied with long decoupling times at short repetition rates. Specified decoupling RF power levels should not be applied for acquisition times longer than 50 ms at 4s repetition rate. For longer acquisition times, the RF level must be decreased to 5 usec or less and less than 5% duty cycle, i.e. 10s recycle time at 500 ms pulses**

Acquire resolution test spectrum with 2 scans at suitable aq and d1 (see fig. 3.3). Save shims. The setup of CP on adamantane need not be repeated for every setup. It is however recommended to repeat the setup for glycine periodically to verify CP/MAS performance.

Set data set to glyangle 1 1

Insert glycine spinner. spin at 5 kHz.

Tune proton channel, then carbon channel. If spinners of the same type are used, the probe tuning should be very close for all samples. Acquire a spectrum of glycine under the same conditions as before except sw=50e3, aq=35m, ns=4, d1=4s, p15 = 1m. Calibrate carbonyl carbon shift as 176.03 ppm (alpha carbon is then 43 ppm). Repeat the acquisition with o1 at 100 ppm, sw 31e3, aq 35m.

Define sigf1= 50, sigf2=40, noisf1 and noisf2 for a region between 160 and 50 ppm where no sidebands or spikes are present, and measure S/N with sino. The measured S/N will be substantially below specs. Set O1 next to the peak at 176.03 ppm (about 500 Hz off). Set sw to 5000, aq=35m.

⇒ **Do not forget to reset aq to 35 m or you will fry your probe and sample!**

Then pulse in gs mode and observe the single C=O resonance. This peak is sensitive to angle setting and precise HH match. Determine the p3=180 degrees, then reset p3=90 degrees, increase proton power, rematch HH condition with C-13 power, check p3=180 degrees again and repeat until p3 has the specified value. Then set pl12=pl2-2dB for increased decoupling power during the acquisition.

Set data set to glycine 4 11 or glycine 7 11, set O1 to 100 ppm, swH to 31e3, aq 35 ms. Repeat the S/N determination at these power levels and p3 for the whole spectrum range. Measure S/N again. The S/N specs should be met. For optimum signal to noise, vary O2 until sharpest and tallest line at 43 ppm is observed, if necessary reduce pl12 by 1 more dB. Usually the best O2 is between 0 and -1000 if the water proton resonance is at 0 offset. Record spectrum, measure S/N of peak at 43 ppm (C- alpha) and line width at half height of peak at 176.03 (C=O). The line width of this peak should be less than a tenth of the instruments proton frequency (less than 30Hz on a 300 MHz instrument). Store HPCU parameters with gethpcu. (See fig. 3.4 for glycine test spectrum).

Standard experiments

3.4

The following 1D experiments should be executed once to provide standard reference files:

- a. Adamantane with HP decoupling, as executed in section 3d
- b. Adamantane low power CP as executed in section 3e
- c. Glycine high power CP as executed in section 3e
- d. additional standard experiments
 - VACP (variable amplitude cp)
 - TOSS, sequence a and b (sideband suppression)
 - SELTICS (sideband suppression)
 - NQS (suppression of protonated carbons).
 - CPVC (variable contact time experiment)
 - CPXT1 (X-nucleus T1 measurement)
 - CPHT1 (proton T1 measurement)

VACP setup

3.4.1

Check whether a ramp RF shape is available, if not:

Open up a new UNIX window. Change to home directory with cd. Start SHAPE or XSHAPE program. Click command line and select I. Set the number of data points to 256. Then select function 10 for triangular pulse. Select function AW to write ASCII file into home directory as filename ramp.

Specify whole and RF. Leave SHAPE and edit ramp file with vi or any other editor. Delete the first amplitudes up to 100%, delete all amplitudes from 50% down. Startup SHAPE again, read in ramp with AR. Save as RF shape file ramp with w, specify whole and RF.

Load data set glyangle 1 1 and edit data set glyvacp 1 1.

Load pulse program vacp. Specify shape for shaped pulse 0 as ramp, set sp0 to value found with H1shape 1 1. In gs mode, vary proton transmitter gain for maximum signal.

Verify that variation of carbon power has little influence on signal intensity. Change to data set Glyvacp 2 1 and reset for observation of the whole glycine spectrum as

CP-MAS Experiments with WB Probes

in Glycine 4 1 1 or Glycine 7 1 1. Acquire 4 scans at 5 kHz and at maximum specified spin rate. Verify that high speed spinning with VACP gives similar S/N and peak heights. If necessary, increase p15 to 3 ms for better S/N on peak at 176.03 ppm.

TOSS setup:

3.4.2

data set glytoss 1 1

With glycine spinner spinning at 5 kHz, load pulse program cptossa and set l31=5000 (spin rate). With p2=2*p3 do 16 scans, watch residual sideband intensity. Vary p2 (usually about 0.2-0.4 usec longer) until best sideband suppression is obtained. For high spin rates sequence cptossa may give an error message because d26 comes out too short. Then load sequence cptossb. The sideband suppression usually works better on 1 side of the peak. Residual sidebands should be less than 3%. If this cannot be achieved, use a spinner with two spacers to reduce the sample volume. (See fig. [3.5](#) for TOSS reference spectrum).

SELTICS setup:

3.4.3

data set glyseltics 1 1

Load cpseltics and set l31=5000 (spin rate). No adjustments are necessary. (See fig. [3.6](#) for SELTICS reference spectrum)

Both sequences will lose S/N on the peak at 43 ppm, but almost nothing on the peak at 176.03 ppm. This is not an instrumental problem but a result of the effective T2. In glycine, this loss will be about 50%.

NQS setup:

3.4.4

data set glynqs 1 1

Load pulse sequence cpnqs, set p2 as found for TOSS, set d3=25 usec for glycine. Accumulate 8 scans. The peak at 43 ppm should be gone.

Watch: for other samples the delay time may have to be much longer for complete suppression. The overall signal to noise will suffer, and the baseline may be a little worse. (See fig. [3.7](#) for NQS reference spectrum).

Multinuclear setup

3.5

For multinuclear instruments and probes, the setup has been done for C-13 on all probes that include the C-13 frequency. In addition, one nucleus at the extreme frequencies of the tuning range should have been run, usually N-15 and/or P-31. Some general considerations concerning MAS or CP/MAS experiments on unusual nuclei.

Quadrupolar nuclei

The reader is referred to the plentiful literature covering MAS experiments on such nuclei, since there are many pitfalls that an inexperienced spectroscopist may suffer if the spectroscopy of those nuclei is not understood.

Problems arise from the following facts:

- First order quadrupolar broadening is frequently larger than the probe bandwidth and requires very precise angle setting. Usually, the sidebands arising from first order broadening span a wide range and their intensities may be falsified by inappropriate excitation and detection.
- Cross polarization is not always possible and always not easily quantifiable.
- For non integer spins, the flip angle of a given pulse depends on the spin quantum number and the first order quadrupolar coupling.
- Isotropic chemical shifts are not at the maximum peak height.
- Even the central transition of non integer spins may be far too broad for detection under MAS conditions. The line width is inversely proportional to the square of the magnetic field, but even in high field spectrometers nuclei with principally high detection sensitivity may not be observable if the local symmetry is low and hence the line widths are large.

Spin 1/2 nuclei

Here it must be considered that even intrinsically sensitive nuclei may be hard to observe due to the following problems:

- T1 in solids is usually prohibitively long for direct observation, hence cross polarization is widely used. However, cross polarization efficiency depends on the dipolar coupling to an abundant spin like ^1H or ^{19}F . Under fast spinning, nuclei that have no directly bonded proton may easily be decoupled by spinning itself and cross polarization is no longer efficient. For many nuclei, the protons available for cross polarization are located in ligands far away from the nucleus of interest.
- Chemical shift anisotropies are large for most nuclei, and at slow spinning, the signal intensity is smeared out over many sidebands, reducing the signal intensity. Also, the isotropic shift is not easily identified among all sidebands because it almost never is the most intense peak. Nuclei which are notoriously difficult because of large CSA are nuclei with order numbers higher than 15, with ^{31}P as an exception due to its high sensitivity. If cross polarization is not necessary, a 4 mm probe spinning at twice the speed of a 7 mm probe will usually give better signal to noise despite the smaller sample volume since less intensity is wasted into sidebands.
- Abundant spin 1/2 nuclei like ^1H or ^{19}F present a problem because of their strong homonuclear coupling which requires either very fast spinning (> 30 kHz for protons, >15 kHz for fluorine in favorable cases due to the usually lower abundance and larger chemical shift range). In such cases, homonuclear dipolar decoupling combined with rotation (CRAMPS) must be applied to achieve narrow lines. This will not work for sample with substantial fluorine and proton content; then very fast spinning, if possible with

CP-MAS Experiments with WB Probes

heteronuclear decoupling must be applied which presents a problem due to the closeness of both resonance frequencies.

Standard nuclei for CP/MAS are C-13, N-15, Si-29 and P-31. For those nuclei, the standard setup conditions are given below. For „exotic“ nuclei, it is important that a suitable CP setup sample be available.

⇒ **Never try to set up CP/MAS on a new sample without prior adjustment of the Hartmann-Hahn condition on a setup sample with good S/N. This would usually be just a waste of time.**

Samples required are:

3.5.2

For N-15 CP-MAS: Doubly labeled ammonium nitrate and natural abundance glycine (as for C-13).

For P-31 CP-MAS: Ammonium dihydrogen phosphate (ADP).

For Si-29 CP-MAS: Q8M8 or DSS (3-(trimethylsilyl)-1-propane sulfonic acid sodium salt)

For special probes, special samples and setups may be required. Ask a solids applications specialist for advice. The following table lists some setup samples and conditions for less commonly observed nuclei:

Table 3.1. Setup samples and conditions for uncommonly observed nuclei

Nucleus	sample	shift (ppm)	relative to	contact time (msec)	recycle time (s)	frequency at $1H=200.13$ MHz	remarks
199Hg	Hg(OAc) ₂	-2487 -2493	Hg(Me) ₂	5	10	35.765352	16 scans, 125 kHz, td=4k
77Se	(NH ₄) ₂ SeO ₄	-1040.	Se(Me) ₂	3	4	38.128907	easy
207Pb	Pb(p-tolyl) ₄	-148.8	Pb(Me) ₄	5	12	41.863710	1 scan
195Pt	K ₂ Pt(OH) ₆			1	4	42.503249	
113Cd	Cd(NO ₃) ₂ *4 H ₂ O	-100	1m Cd (ClO ₄) ₂	15	8	44.381609	
119Sn	Sn(cyclohexyl) ₄	-97.35	Sn(Me) ₄	1	10	74.639360	1 scan

General setup procedures:

3.5.3

Finding the HH condition on a nucleus other than carbon is much facilitated if the X-nucleus power is pre-adjusted according to the different magnetic moment of this nucleus.

For N-15, the X-nucleus HH pulse pp voltage must be increased by a factor of 2.47,

for Si-29, this factor is 1.27,

for P-31, the factor is 0.62.

Especially for very low frequency nuclei this may mean very high power requirements for the X-nucleus pulse. It is recommended to reduce the proton pulse width by 1.5 usec for N-15 and 0.5 usec for Si-29 for increased safety. The RF power during decoupling may be kept at the same level. The quickest way for set-up is to adjust these reduced CP power levels with glycine on C-13, reset the X-power for HH and measure the pp voltage of the X-frequency contact pulse. Then retune the transmitter for the new X-frequency and set the pp voltage that has been calculated. Then retune probe with new setup sample.

The HH condition should be very close. Measurement parameters:

- Spin rate 5 kHz on either sample Ammonium nitrate,

N-15:

⇒ **Take care, ammonium nitrate may explode when wet!!! -**

- p3= 5.5 usec (6 usec at 400 MHz or higher)

- p15 = 5 ms

- swh= 31e3

- aq=100 ms,

- d1=10s, 2 scans (see fig. [3.8](#) for NH₄NO₃ reference spectrum)

Reference low field peak as 0

Glycine, natural abundance N-15:

- aq 35 ms, 4 scans (8 scans for 100 MHz instruments)

- p15 = 3 ms

Reference peak to -342 ppm. (See fig. [3.9](#) for reference spectrum).

Q8M8, Si-29:

- p3= 4.5 usec (5 usec at 400 MHz or higher)

- p15 = 5-10 ms

- swh = 31e3

- ns = 4

- aq = 150 ms (decoupling power same as for CP)

- d1 = 15s (see fig. [3.9](#) for Q8M8 reference spectrum)

Reference low field higher peak to -12.6 ppm

DSS, Si-29:

- aq = 35 ms

Reference peak to 0 ppm. (See fig. [3.11](#) for DSS reference spectrum).

ADP, P-31

- p3 = 4 usec (4.5 usec at 400 MHz or higher)
- swh = 50e3 (to provide for samples other than ADP)
- aq = 35 ms
- d1 = 4 s

Reference peak to 0 ppm. (See fig. [3.12](#) for ADP reference spectrum).

Quadrupolar Nuclei

3.6

Introduction

3.6.1

Nuclei with a spin $I > 1/2$ possess a quadrupole moment resulting from a non-spherical distribution of the electric charge the nucleus. The interaction of the quadrupole moment with the gradient in the electric field produces an effect on the NMR spectrum which can provide information about the local structure.

Unlike a spin $I=1/2$ spectrum, which consists of only one transition, the spectrum of quadrupolar nuclei consists of $2I$ transitions. For nuclei with odd half-integer spins a so-called central transition ($1/2 \leftrightarrow -1/2$) and in addition $(2I - 1)$ so-called satellite or outer transitions are observed, for nuclei with integer spin only $(2I - 1)$ „satellite“ transitions will be observed. In a static spectrum where no quadrupole interaction (perturbation) is active a single frequency for all equally spaced energy levels at the Larmor frequency is obtained. Under the influence of first-order quadrupole perturbation the central transition is not effected and the (non-central) satellite transitions are spread over a frequency range of the quadrupole frequency $= (3C_q)/(2I(2I - 1))$ which can be easily in the MHz range. Hence usually only the central transition is observed. If the quadrupole interaction is sufficiently large second-order quadrupole perturbation has to be considered which gives rise to the characteristic powder patterns.

To improve resolution and to remove anisotropic contributions the standard technique is to rotate the sample rapidly at the magic angle (54.7°) to the magnetic field. This very effectively removes the first-order perturbations. However, for the more complex angular variation of the second-order perturbation MAS at a finite speed can only produce partial narrowing. Typical MAS spectra of nuclei with odd half-integer spin consist of the center band of the central transition plus a set of side bands of the satellite transition(s).

Experimental procedures

3.6.2

The most common experiment for NMR of quadrupolar nuclei is a single pulse experiment combined with fast MAS. For a correct and complete interpretation of such spectra some care has to be taken for the set-up of the experiments. In the following sections the methods to provide fully interpretable spectra are given.

Pulse determination

The main difference between NMR of quadrupolar nuclei and spin-1/2 nuclei is that their pulse response depends on the quadrupolar coupling constant (C_q).

There are two limiting cases. Either $\nu_q \gg \nu_1 [= (\gamma B_1)/(2\pi)]$ and the central transition is well separated from the outer ones and the pulse response is $A \sin A \omega_1 \tau_p [A = \sqrt{I(I+1) - m(m-1)}]$. This is called a fictitious spin-1/2 system where the magnetization corresponding to the different transitions behaves as an independent spin-1/2 system but its gyromagnetic ratio is enhanced and its intensity is diminished by a factor A. In the other limit $\nu_1 \gg \nu_q$ and the energy levels become almost equally spaced. Here the transitions are degenerate and the nucleus behaves as a spin -1/2 nucleus with the same gyromagnetic ratio and response $A^2 \sin \omega_1 \tau_p$. Between these two limits the pulse response becomes complex and non-sinusoidal.

A nice example to demonstrate this behavior is to compare the Al-27 resonance in an aqueous Al (ClO₄)₃ solution with the Al-27 resonance in the (solid) sample YAG (Y₃Al₅O₁₂) as a function of the applied pulse lengths. YAG is a sample containing a four co-ordinated Al site with a C_q=6 MHz and a six co-ordinated site with C_q=0.6 MHz. In these examples all three cases are presented and differences in the intensities are clearly visible (fig. 3.13).

These effects are of particular importance for experiments where quantitatively reliable data have to be obtained. Only if C_q is known any pulse length can be used because a correction can be calculated. In all other cases with no accurate knowledge of C_q the small pulse angle limit has to be used. Then at both limits the observed intensity tends to $A^2 \omega_1 \tau_p$. For quantitative comparison with less than 5% error it is recommended to fulfill the relation:

$$(I + 1/2)\omega_1 \tau_p \leq \pi/6$$

where $\omega_1 = \gamma B_1$ and τ_p is the pulse length. Experimentally the pulse determination has accurately to be done either using a well-known solid sample for the set-up or using a dissolved or a liquid set-up sample.

For the dissolved and also for the liquid sample the determination of the 90° pulse can be done straightforward via the 180° pulse. Of course neither of the two types of samples will be spun. Suitable parameters to start with are:

sfo1 = according to the nuclei table	d1 = 1s (200 ms)
ns = 1...4 (100)	swh = 125 kHz
td = 1k	p1 = 4...5 μs
Power ≤ 300W	d3 = 10 μs

For the set-up samples given in the table above (below) a signal will be visible on one shot or alternatively on the indicated number of scans but with a short recycle delay. Once the resonance frequency of the signal is determined you can e.g. use the program paropt for the pulse determination. Be careful not to use a large frequency offset to avoid a misadjusted 90° pulse due to off resonance effects, being up to 1 kHz off resonance to a narrow ≤ 1kHz line will be all right. For wider lines the pulse determination should be done on resonance. The chemical shift of this signal can furthermore be used for external chemical shift referencing.

When the pulse determination is done on the liquid sample the final 90° pulse in solution and therefore the corresponding power should be adjusted such that the above given relation can still be fulfilled, i.e. that τ_p does not become too short. In the table below the pulse lengths that should be used for a spin-I nucleus are given assuming a 90° pulse of 10 μs $\nu_1 = 25\text{kHz}$:

$I =$	3/2	$\tau_p =$	1.7 μs
	5/2		0.6 μs
	7/2		0.4 μs
	9/2		0.3 μs

As a rule of thumb the relation between the 90° pulse in solution and the 90° pulse being used for the solid sample with a large quadrupole interaction (first case from above) is $(90_{(\text{solid})}) = (90_{(\text{solution})}) / (I + 1/2)$. In fact in a complex sample with sites of different quadrupole interaction there is no unique 90° pulse over the whole sample and a compromise has to be used.

If no liquid sample for the pulse determination is available a well characterized solid sample has to be used for the pulse calibration. This is always to be preferred because of two reasons. Firstly the properties of a solvent can be such that the Q-factor of the probe is effected resulting in an inaccuracy of the pulse determination. Secondly a solid sample is always much better to verify the performance of the instrument.

In fig. **3.13** (top) on the left the result of paropt using YAG as sample looking at the Al-27 resonance is shown. For the Al(4) site the maximum signal is reached at 1.2 μs , for the Al(6) site at 1.6 μs . For the liquid sample, however, at the same RF power a maximum signal is reached at 6 μs . Using 0.4 μs will allow to integrate the centre lines of the central transitions giving a compensated ratio of 2.9: 2 compared to a ratio of 3:2 as a result of an X-ray analysis.

Spinning speed

What is the optimum spinning speed to be used in an MAS experiment of quadrupolar nuclei? Looking at the central transition only one should spin fast enough to get the centreband region free from rotational sidebands. To appreciate the progress achieved with higher magnetic fields and faster MAS the following example may be given: For Al-27 the early studies at moderate spinning speeds of 4 kHz at 7.05 T allowed to resolve lines with about 4.9 MHz C_q , while with 15 kHz at 11.7 T this has increased to about 12.3 MHz.

If the satellite transition also contributes to the spectrum spinning side bands in the centre band region of the central transition will also be visible at not fast enough spinning. As their width is usually narrower than the one of the central transition their intensity can be significant. In this case the rule is the faster spinning the better, even if no further line narrowing can be obtained.

Angle accuracy

With an increased C_q a more and more accurate setting of the magic angle is required. Then the angle setting using KBr as described in the previous chapter 4.3.3 is no longer accurate enough because in this sample the C_q is relatively small. The larger C_q the more a misset angle will be noticeable. Assuming that the magic angle $\beta = 54.7^\circ$ is misset by $d\beta$ and spinning the sample at $(\beta + d\beta)$ then the residual width is broadened by a factor $\sqrt{2}d\beta$. Therefore in principle the reference sample for angle adjustment should have a quadrupole interaction which is at least in the order of the interaction of unknown samples. This is obviously hardly the case so that the angle should be set on the sample itself, but since this can be very time consuming or sometimes even impossible a slight misadjustment may have to be excepted.

Dead time delay

BRUKER CP/MAS probes are NMR probes with high sensitivity which necessitates a high Q-factor. As discussed elsewhere a consequence of a high Q-factor is a relatively long dead time. Dependent on the NMR frequency this will be from 10 μ s up to 100 μ s. As a consequence the acquisition has to be started several 10 μ s after the pulse and a considerable first-order phase correction will be necessary after Fourier Transformation. In general, if the sampling rate (dwell time, dw) is dw (s) and the first point of the FID is sampled d3 μ s after the top of the pulse, then the first-order phase correction will be:

$$\text{phc}^{(1)} = - d3/dw * 180^\circ$$

A typical parameter for d3 is 10 μ s and for dw is 200 ns. With these the first-order phase correction will be $-10/0.2 * 180^\circ = -9000^\circ$. As a result a so-called rolling baseline is obtained.

To circumvent this large first-order phase correction the according number of points can be included, in the simplest way by right shifting. The result of the Fourier Transformation will be identical as before, with the same baseline roll but now without any first-order phase correction. The mathematical explanation for this is that the delayed acquisition generates a step function into the FID the Fourier transform of which is a $\sin x/x$ function (sinc-function). Right shifting before FT or applying a corresponding phase correction after FT is mathematically identical.

Either of the two procedures described above is necessary to get a properly phased spectrum but further post processing like baseline correction will be necessary. When broad lines are to be handled this can be connected with some error with respect to the proper line shape unless a sinc-type baseline correction is applied. A method will be described below which allows to yield a spectrum with the right first-order phase correction and a corrected baseline in one step.

Backwards Linear Prediction

The UXNMR software package provides a tool which allows to calculate the data points between the top of the pulse and the beginning of the FID by means of linear prediction (LP) methods. There are four parameters to be defined in the edp menu, which is shown in the appendix (fig. 3.14):

ME_mod = flag which has to be selected as LPbr for linear prediction backwards real. The following are the possible choices for this flag:

no: no LP is performed

LPbr/LPbc: Backward linear prediction is performed, real (r) or complex (c) is automatically selected according to aqmod, only important when ft is performed via the command trf. Which parameters are used to either replace the first n points of an FID or to add n points to the beginning of the FID is explained below.

LPfr/LPfc: Forward linear prediction is performed. Please refer to the UXNMR manual how to perform this processing.

The following parameters are used for this processing step and have to be defined:

NCOEFF = number of coefficients. It represents the number of coefficients used for the LP calculation. Ideally this parameter should be set to 2 to 3 times the number of expected peaks. A value of 100 for this type of spectra is a reasonable value to start with. It has to be optimised by trial and error.

LPBIN = number of input points for LP calculation. It depends on the length of the FID and should be selected such that the relaxation characteristics of the FID is recognized.

TDoff = number of points to be calculated. If TDoff is positive it represents the number of points which are replaced at the beginning of the FID, if it is negative it represents the number of points which are calculated and added to the beginning of the FID.

If the pre-acquisition delay is long enough such that no dead time is visible in the first points of the FID, TDoff can directly be set to the number of points to be calculated. A nice trick may help to determine how many points have to be calculated: In most cases rotational echoes are visible on the FID, and the number of data points between the second and the third echo must be equal to the number of points between the first and the second echo. The first echo, however, will never be visible in the accumulated FID because it is created at the top of the pulse and would completely be scrambled by the dead time of the probe. The LP algorithm allows to calculate the signal how it would be like if no dead time effects were present.

If the pre-acquisition delay was too short and some dead time is visible in the FID, then one has to get rid of these points by left-shifting. To do left-shifts or right-shifts in UxNMR the first step is always to execute the command bc. This will perform a baseline correction on the FID according to the flag bcmod and it will separate the FID into its real and imaginary parts and store the result in the files 1r and 1i in the processed data sub-directory. Since the commands ls and rs are performed on the processed data by default, these two files have to exist and contain the proper data. Have in mind, that by looking to the cursor points, only the real part (i.e. 50%) is displayed. As a consequence if the dead time is determined with the cursor to be e.g. 20 points, the parameter nsp has to equal 40 in order to perform 20 left shifts on the real plus 20 left shifts on the imaginary data.

In the example shown in the appendix (fig. [3.15](#)), A represents the real part of a typical FID of an MAS spectrum of a quadrupolar nucleus (here again the Al-27 spectrum of YAG is shown). The second and third echo appear at point numbers 76 and 154, respectively. 154 minus 76 equals 78, which means the in principal 2 times 2 points have to be linear predicted. However, since there is some dead time visible in the first 10 points of the real part 20 points of total left shifting has to be done in a first step. Please note, that right or left shifting of an odd number of data points has an important influence on the data because real and imaginary data are interchanged. For sequentially accumulated data this means that after FT the spectrum will be reversed which can be taken care of with the command rv. Simultaneously recorded data, however, will be totally scrambled because quad images of increasing intensities with increased frequency offsets will be generated. In the example (fig. [3.15](#)) the data were processed as follows:

1. bc perform linear baseline correction on the FID (dc correction) and store result in 1r and 1i files
2. nsp(20 (in this example))
3. lsperform 10 left shifts on real and 10 left shifts on imaginary part (total of 20)
4. set parameters for backwards LP e.g. in the edp menu:
 - 4.1. ME_modLPbr
 - 4.2. NCOEFF(600 (in this example), has to be optimised by trial and error

4.3. LPBIN(6k (in this example), depends on the length of the FID

4.4. TDoff ([20(2((154(76(76)] ((24 (in this example)

5. em

LPbr is performed with any further processing step on the data, like applying a window function or Fourier Transformation. If lb (0, then the em command enables to look at the result of the LP on the time domain data before ft. If this is not desired this step can be omitted.

6. ft

About 0° for the first-order phase correction have to be applied. If a considerable first-order phase correction has to be applied to get a properly phased spectrum one of the parameters was incorrectly set.

As an aid, if the value for the first-order phase correction is largely positive, too many points have been predicted, i.e. the FID starts now at $t < 0$, a considerable negative value means that not enough points have been predicted. This is always only true if these values are in the order on n times 180° . This can be adjusted by incrementing or decrementing the number of predicted points (TDoff). However, due to a non-linearity of the probe response it will always be possible that the sideband signals to the far left and to the far right in the spectrum do not have completely identical phase. This is of course an effect which cannot be taken care of by means of linear prediction. Also, this method will not be able to calculate any magnetization that has decayed during the pre-acquisition delay.

As a matter of convenience it is probably a good idea to create a macro containing the commands bc, ls, and efp which speeds up this type of processing. For more information about how to write macros please refer to the UXNMR manual.

In fig. [3.15](#), B shows the result of applying left shifts plus LP on the FID; the first, second, and third echoes are now all equally spaced. In C and D the results of the Fourier Transformations of A and B are shown, respectively. In D only the left shifts have been applied to get rid of the dead time and as a consequence there is a large first-order phase correction.

Appendix:

3.7

AU program angle

3.7.1

/*

angle (940201)

performs multiple acquisitions and ft's. can be stopped while entering „stop“ during acquisition

*/

```
/* Ste */

char *Gets(),strt[8];
int ns, nss;

GETCURDATA
Proc_err(0, "Terminate AU program with „stop“ during acquisition");
(void)strcpy(strt, Gets(„Do you want adjustment on spectrum? y/n“, „y“));
i1=100000;
fetchpar(„NS“, &ns);
TIMES(i1)
    storepars(„NS“, (ns+1));
    ZG
    fetchpars(„NS“, &nss);
    if (nss!= ns)
    {
        break;
    }
    if (strt[0] == 'y')
    {
        EFP
    }
END
QUITMSG(„--- angle program finished ---“)
```

Reference spectra

3.7.2

- fig. [3.1](#), [3.2](#): KBr MAS off/on angle
- fig. [3.3](#): adamantane resolution test
- fig. [3.4](#): glycine angle and sensitivity test
- fig. [3.5](#): TOSS on glycine
- fig. [3.6](#): SELTICS on glycine
- fig. [3.7](#): NQS on glycine
- fig. [3.8](#): CP/MAS of doubly labelled ammonium nitrate, NH₄NO₃
- fig. [3.9](#): N-15 CP/MAS of natl. abundance glycine sensitivity test
- fig. [3.10](#): Si-29 resolution and sensitivity test of Q8M8
- fig. [3.11](#): Si-29 sensitivity test of DSS

- fig. **3.12**: P-31 sensitivity test of ammonium dihydrogen phosphate, ADP, $\text{NH}_4\text{H}_2\text{PO}_4$
- fig. **3.13**: Comparison of pulse determination in a solid sample of YAG and in an aqueous solution of $\text{Al}(\text{ClO}_4)_3$
- fig. **3.14**: Processing parameter display (edp) showing the parameters to set up backward linear prediction
- fig. **3.15**: Comparison of fid's and spectra with and without treatment by backward linear prediction

CP-MAS Experiments with WB Probes

Figure 3.1. KBr MAS off angle

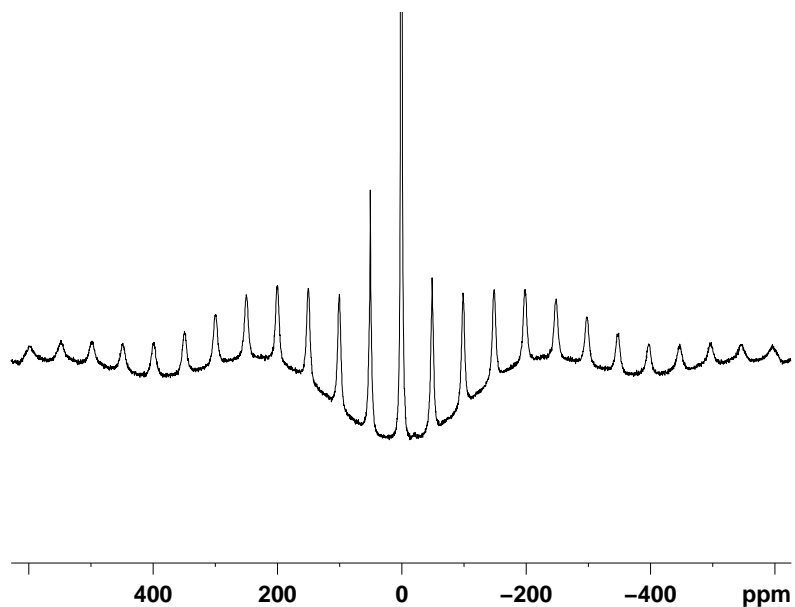

KBr Br-79 MAS spectrum off angle
note broad sidebands

Current Data Parameters
 NAME kbroff
 EXPNO 1
 PROCNO 1

F2 - Acquisition Parameters
 Date_ 960715
 Time 9.23
 INSTRUM spect
 PROBHD MAS 4 mm
 PULPROG zgadc.rel
 TD 4997
 SOLVENT CDCI3
 NS 128
 DS 0
 SWH 125786.164 Hz
 FIDRES 25.172337 Hz
 AQ 0.0199131 sec
 RG 1024
 DW 3.975 usec
 DE 5.68 usec
 TE 300.0 K
 PL1 15.00 dB
 D1 0.10000000 sec
 SFO1 100.2541240 MHz
 NUC1 79Br
 P1 1.00 usec
 D3 0.00003000 sec

F2 - Processing parameters
 SI 4096
 SF 100.2540316 MHz
 WDW no
 SSB 0
 LB 0.00 Hz
 GB 0
 PC 1.00

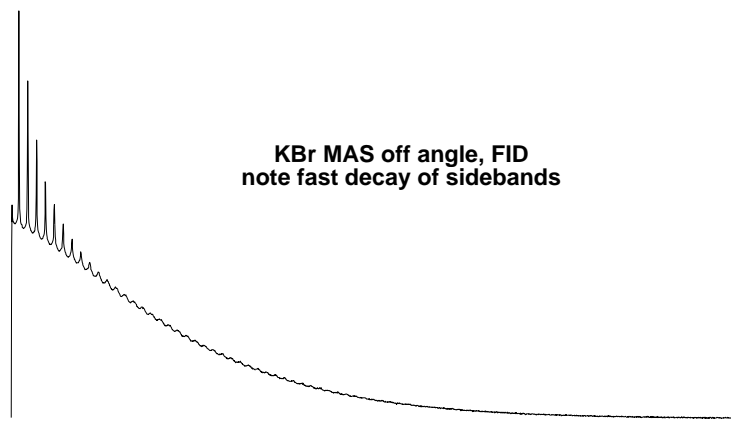

KBr MAS off angle, FID
note fast decay of sidebands

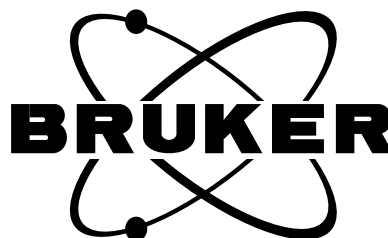
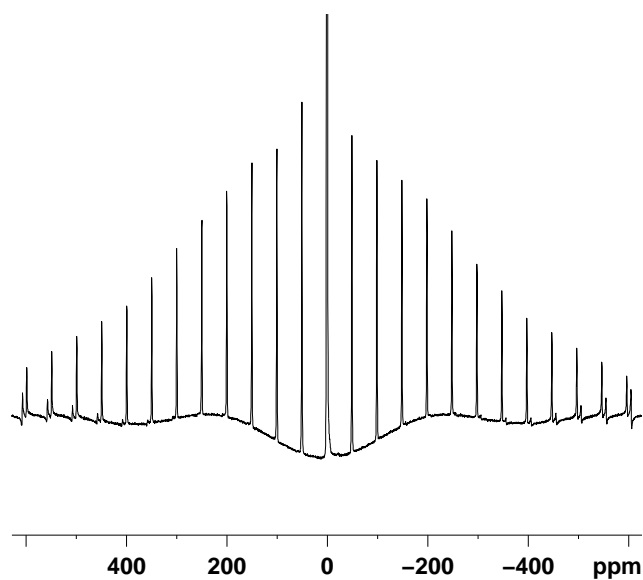
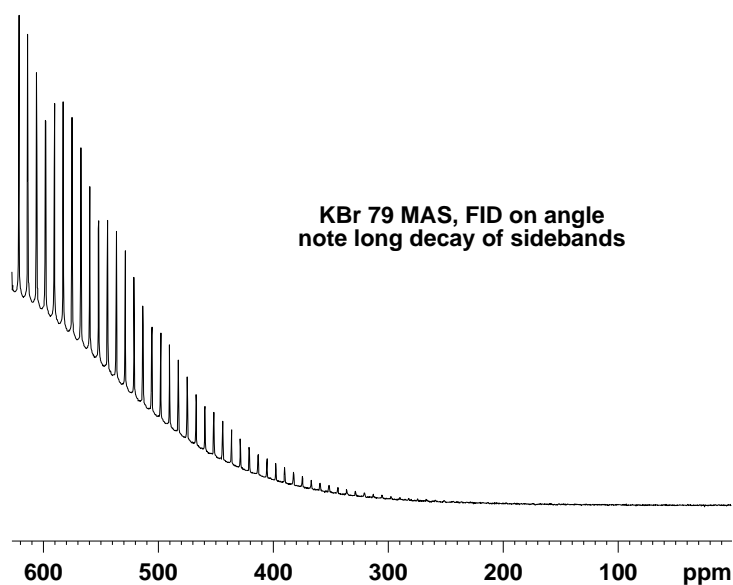

Figure 3.2. KBr MAS on angle



KBr Br-79 spectrum, angle set
note folded in sidebands due to 125 kHz SWH
baseline distorted due to deadtime delay



KBr 79 MAS, FID on angle
note long decay of sidebands

Current Data Parameters

NAME kbron
EXPNO 1
PROCNO 1

F2 - Acquisition Parameters

Date_ 960715
Time 9.21
INSTRUM spect
PROBHD MAS 4 mm
PULPROG zgadc.rel
TD 4997
SOLVENT CDCl3
NS 128
DS 0
SWH 125786.164 Hz
FIDRES 25.172337 Hz
AQ 0.0199131 sec
RG 1024
DW 3.975 usec
DE 5.68 usec
TE 300.0 K
PL1 15.00 dB
D1 0.1000000 sec
SFO1 100.2541240 MHz
NUC1 79Br
P1 1.00 usec
D3 0.00003000 sec

F2 - Processing parameters

SI 4096
SF 100.2540316 MHz
WDW no
SSB 0
LB 0.00 Hz
GB 0
PC 1.00

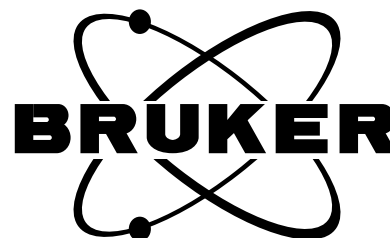
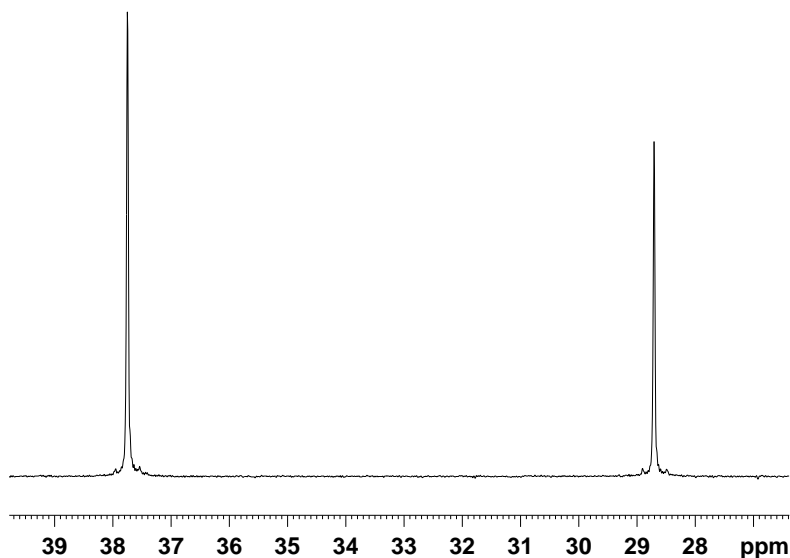

Figure 3.3. Adamantane resolution test



```

Current Data Parameters
NAME      adamres
EXPNO     2
PROCNO    1

F2 - Acquisition Parameters
Date_     950420
Time      14.54
INSTRUM   spect
PROBHD    MAS 7mm
PULPROG   cp.rel
TD         8192
SOLVENT   solid
NS         8
DS         0
SWH        9980.040 Hz
FIDRES     1.218267 Hz
AQ         0.4104692 sec
RG         512
DW         50.100 usec
DE         4.50 usec
TE         300.0 K
PL1        10.00 dB
D1         10.00000000 sec
PL2        3.00 dB
SFO2       299.8700000 MHz
NUC2       1H
SFO1       75.4063410 MHz
NUC1       13C
P3         4.25 usec
P15        5000.00 usec
PL12       3.00 dB
D3         0.00005000 sec

F2 - Processing parameters
SI         16384
SF         75.4019839 MHz
WDW        no
SSB        0
LB         0.00 Hz
GB         0
PC         1.00
    
```

adamres 1 1, test spectrum for adamantane resolution.
 aq=400 ms, resolution 2.5 Hz

Good resolution is harder to get at higher fields and for 4 mm spinners.
 SiN spinners are somewhat easier to shim.

**USE LOW POWER LEVELS AND LONG RECVLE DELAYS FOR THIS TEST!
 NEVER RUN THESE CONDITIONS WITH REGULAR POWER LEVELS AND RECYCLE TIMES!**

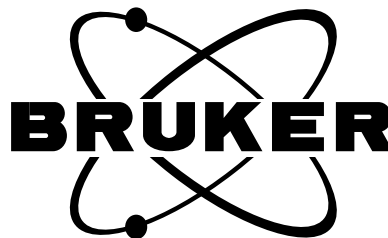
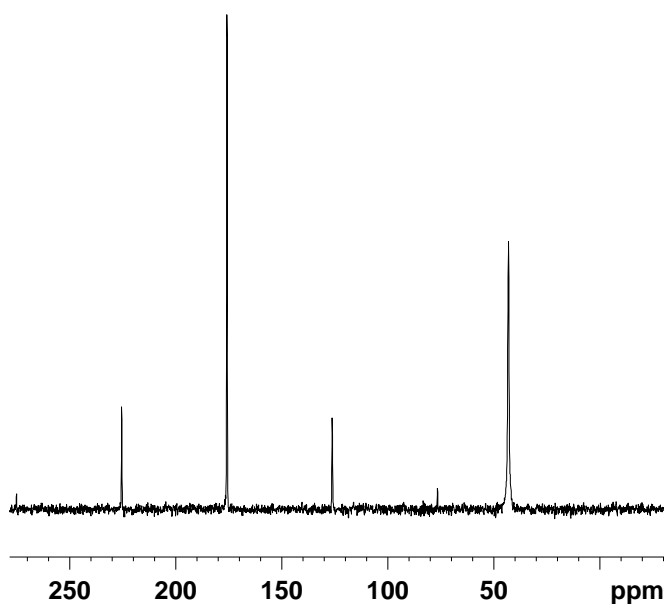
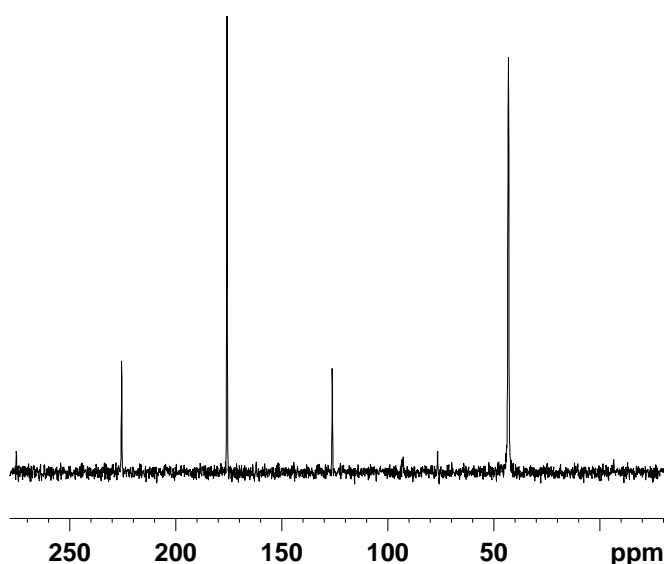

Figure 3.4. Glycine angle and sensitivity test



Glycine signal to noise test
DSX 400, MASR 5000, aq 35 msec
CW decoupling, WVT 4 mm probe
S/N 53:1



Glycine signal to noise test
DSX 400, MASR 5000, aq 35 msec
tppm decoupling, WVT 4 mm probe
S/N 65:1

Current Data Parameters
NAME glycine44
EXPNO 2
PROCNO 1

F2 - Acquisition Parameters
Date_ 960710
Time 14.37
INSTRUM spect
PROBHD MAS 4 mm
PULPROG vacptppm.rel
TD 2184
SOLVENT CDCl3
NS 4
DS 0
SWH 31055.900 Hz
FIDRES 14.219735 Hz
AQ 0.0352124 sec
RG 4096
DW 16.100 usec
DE 5.68 usec
TE 300.0 K
PL1 15.50 dB
D1 4.00000000 sec
PL12 9.00 dB
P3 2.70 usec
SFO2 400.1305000 MHz
NUC2 1H
PL2 11.00 dB
P15 2000.00 usec
SFO1 100.6250499 MHz
NUC1 13C
SP0 10.00 dB
SPOFF0 0.00 Hz
SPNAM0 down
CPDPRG2 tppm
P21 5.40 usec
D3 0.00000115 sec
DE 5.68 usec

F2 - Processing parameters
SI 4096
SF 100.6125707 MHz
WDW no
SSB 0
LB 0.00 Hz
GB 0
PC 1.00

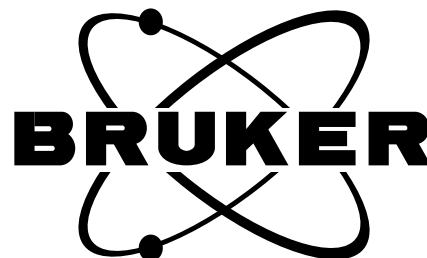

CP-MAS Experiments with WB Probes

Figure 3.5. TOSS on glycine

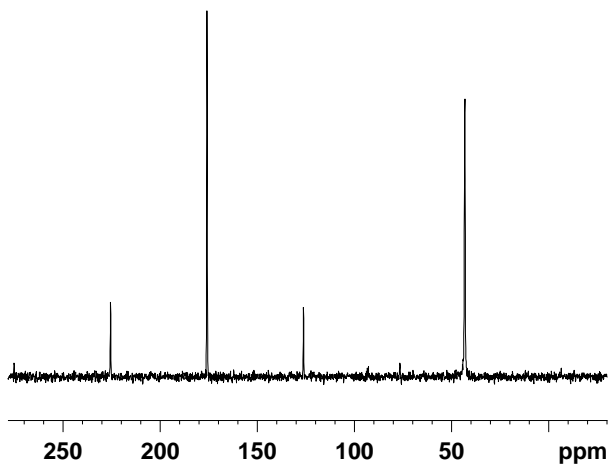

Glycine signal to noise test
 DSX 400, MASR 5000, aq 35 msec
 tppm decoupling, WVT 4 mm probe
 S?N 65:1

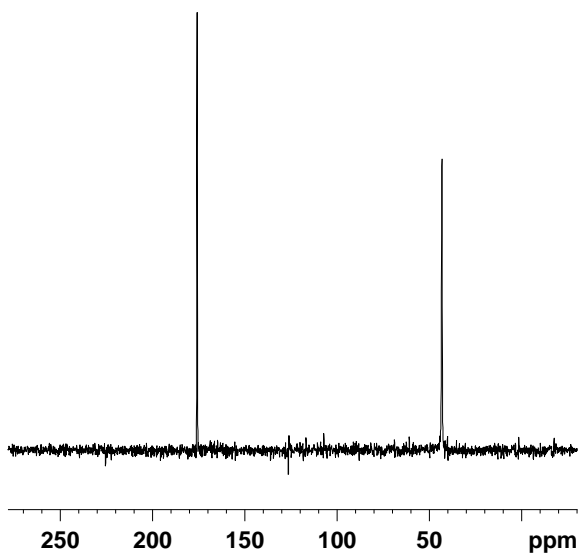

Toss with vacp, spin rate 5 kHz
 timing b (more suitable for fast spin rates)
 P2 must be carefully set

```

Current Data Parameters
NAME      glycine44
EXPNO     2
PROCNO    1

F2 - Acquisition Parameters
Date_     960710
Time      14.37
INSTRUM   spect
PROBHD    MAS 4 mm
PULPROG   vacptppm.rel
TD         2184
SOLVENT   CDCI3
NS         4
DS         0
SWH        31055.900 Hz
FIDRES     14.219735 Hz
AQ         0.0352124 sec
RG         4096
DW         16.100 usec
DE         5.68 usec
TE         300.0 K
PL1        15.50 dB
D1         4.00000000 sec
PL12       9.00 dB
P3         2.70 usec
SFO2       400.1305000 MHz
NUC2       1H
PL2        11.00 dB
P15        2000.00 usec
SFO1       100.6250499 MHz
NUC1       13C
SP0        10.00 dB
SPOFF0     0.00 Hz
SPNAM0     down
CPDPRG2    tppm
P21        5.40 usec
D3         0.00000115 sec
DE         5.68 usec

F2 - Processing parameters
SI         4096
SF         100.6125707 MHz
WDW        no
SSB        0
LB         0.00 Hz
GB         0
PC         1.00
    
```

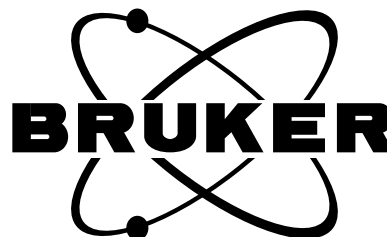
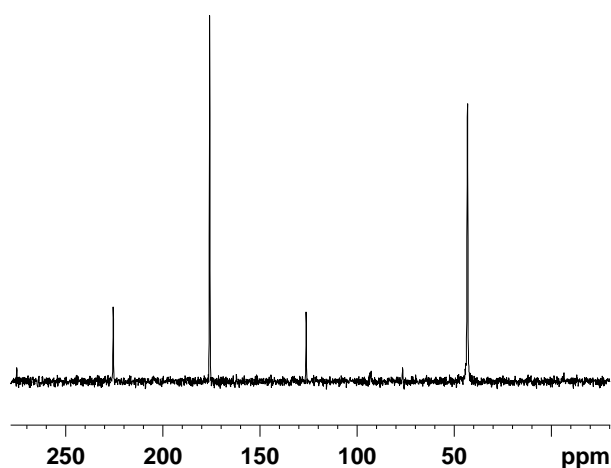
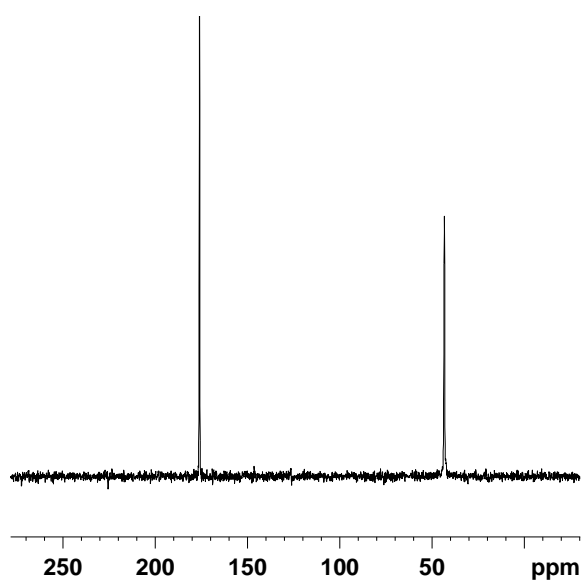

Figure 3.6. SELTICS on glycine



Glycine signal to noise test
 DSX 400, MASR 5000, aq 35 msec
 tppm decoupling, WVT 4 mm probe
 S?N 65:1



SELTICS sideband suppression on glycine
 5 kHz spin rate

Current Data Parameters

```

NAME      glycine44
EXPNO     2
PROCNO    1

F2 - Acquisition Parameters
Date_     960710
Time      14.37
INSTRUM   spect
PROBHD    MAS 4 mm
PULPROG   vacptppm.rel
TD         2184
SOLVENT   CDCl3
NS         4
DS         0
SWH       31055.900 Hz
FIDRES    14.219735 Hz
AQ        0.0352124 sec
RG         4096
DW         16.100 usec
DE         5.68 usec
TE         300.0 K
PL1        15.50 dB
D1         4.00000000 sec
PL12       9.00 dB
P3         2.70 usec
SFO2       400.1305000 MHz
NUC2       1H
PL2        11.00 dB
P15        2000.00 usec
SFO1       100.6250499 MHz
NUC1       13C
SP0        10.00 dB
SPOFF0     0.00 Hz
SPNAM0     down
CPDPRG2    tppm
P21        5.40 usec
D3         0.00000115 sec
DE         5.68 usec

```

F2 - Processing parameters

```

SI         4096
SF         100.6125707 MHz
WDW        no
SSB        0
LB         0.00 Hz
GB         0
PC         1.00

```

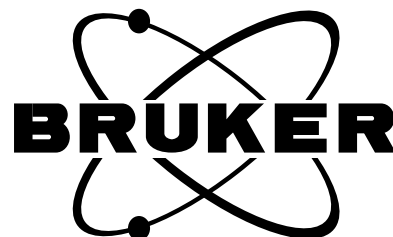
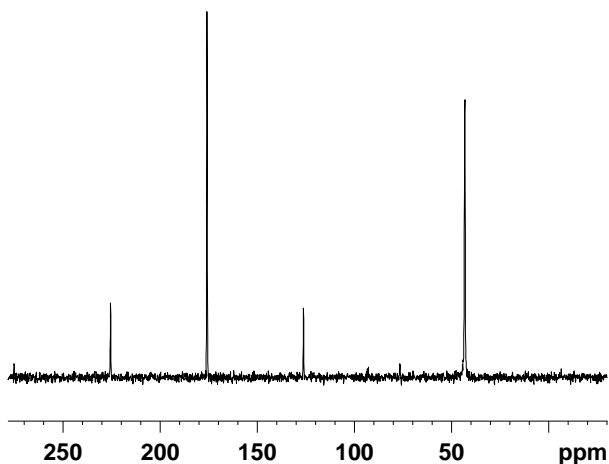
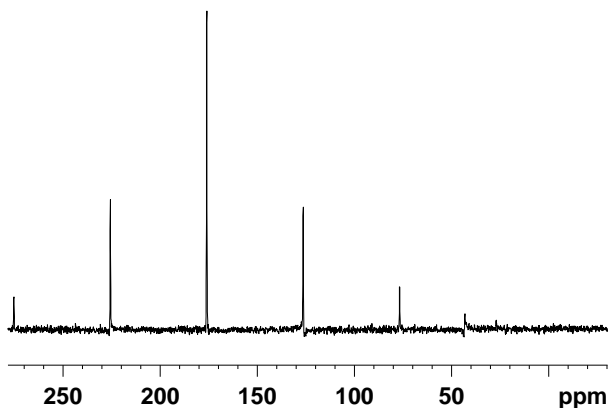

Figure 3.7. NQS on glycine



Glycine signal to noise test
 DSX 400, MASR 5000, aq 35 msec
 tppm decoupling, WVT 4 mm probe
 S?N 65:1



Glycine, nqs spectrum, 2*30usec interruption
 with carbon pi refocussing pulse

```

Current Data Parameters
NAME      glycine44
EXPNO     2
PROCNO    1

F2 - Acquisition Parameters
Date_     960710
Time      14.37
INSTRUM   spect
PROBHD    MAS 4 mm
PULPROG   vacptppm.rel
TD         2184
SOLVENT   CDCl3
NS         4
DS         0
SWH       31055.900 Hz
FIDRES    14.219735 Hz
AQ         0.0352124 sec
RG         4096
DW         16.100 usec
DE         5.68 usec
TE         300.0 K
PL1        15.50 dB
D1         4.00000000 sec
PL12       9.00 dB
P3         2.70 usec
SFO2       400.1305000 MHz
NUC2       1H
PL2        11.00 dB
P15        2000.00 usec
SFO1       100.6250499 MHz
NUC1       13C
SP0        10.00 dB
SPOFF0     0.00 Hz
SPNAM0     down
CPDPRG2    tppm
P21        5.40 usec
D3         0.00000115 sec
DE         5.68 usec

F2 - Processing parameters
SI         4096
SF         100.6125707 MHz
WDW        no
SSB        0
LB         0.00 Hz
GB         0
PC         1.00
    
```

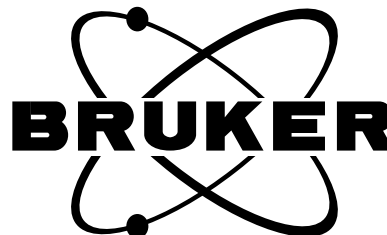
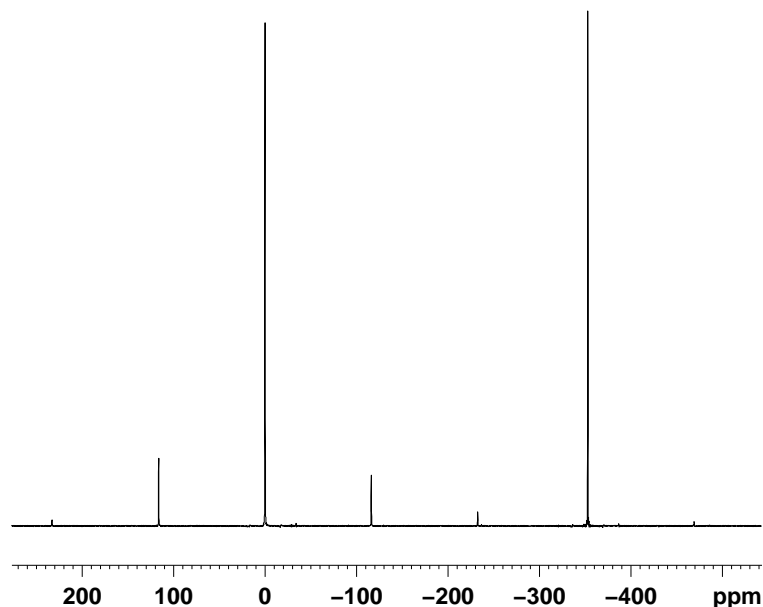

Figure 3.8. CP/MAS of doubly labeled ammonium nitrate, NH_4NO_3 

NH₄NO₃, N-15 CP/MAS reference sample
DSX 300

Current Data Parameters
NAME nh4no3
EXPNO 1
PROCNO 1

F2 - Acquisition Parameters
Date_ 950607
Time 12.15
INSTRUM spect
PULPROG cp.rel
TD 6246
SOLVENT Aceton
NS 4
DS 0
SWH 31055.900 Hz
FIDRES 4.972126 Hz
AQ 0.0999860 sec
RG 1024
DW 16.100 usec
DE 4.50 usec
TE 300.0 K
PL1 10.00 dB
D1 5.00000000 sec
PL2 2.00 dB
SFO2 299.8700000 MHz
NUC2 1H
SFO1 30.3909123 MHz
NUC1 15N
P3 6.50 usec
P15 5000.00 usec
PL12 2.00 dB
D3 0.00003000 sec

F2 - Processing parameters
SI 16384
SF 30.3967943 MHz
WDW no
SSB 0
LB 0.00 Hz
GB 0
PC 0.10

1D NMR plot parameters
CX 20.00 cm
F1P 260.270 ppm
F1 7911.37 Hz
F2P -432.809 ppm
F2 -13156.00 Hz
PPMCM 34.65393 ppm/cm
HZCM 1053.36853 Hz/cm

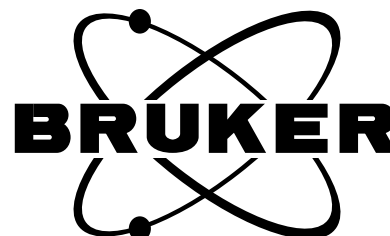
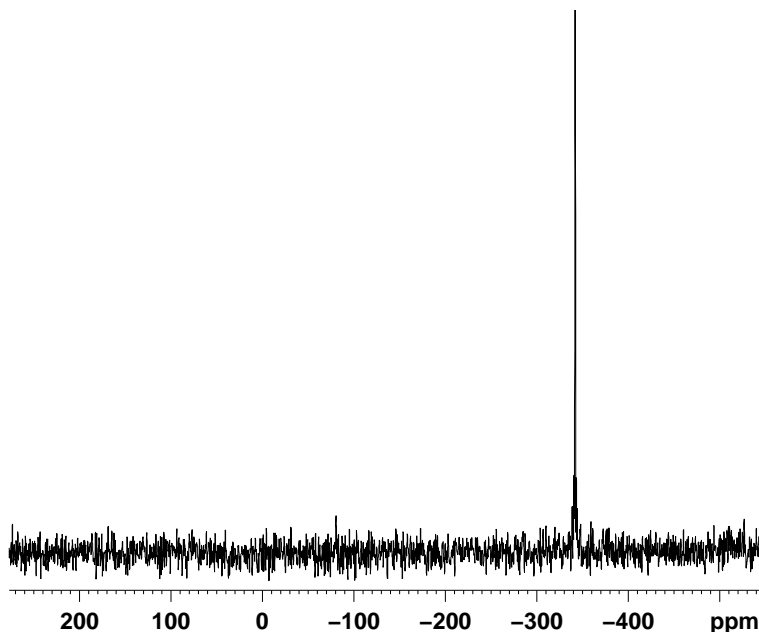

Figure 3.9. N-15 CP/MAS of natl. abundance glycine sensitivity test



N-15 CP/MAS sensitivity test, natl. abundance glycine
7 mm probe, S/N 35 :1, 4 scans
DSX 300

```

Current Data Parameters
NAME      glyn15
EXPNO     1
PROCNO    1

F2 - Acquisition Parameters
Date_     950607
Time      12.26
INSTRUM   spect
PULPROG   cp.rel
TD         2184
SOLVENT   Aceton
NS         4
DS         0
SWH        31055.900 Hz
FIDRES     14.219735 Hz
AQ         0.0349940 sec
RG         1024
DW         16.100 usec
DE         4.50 usec
TE         300.0 K
PL1        10.00 dB
D1         10.00000000 sec
PL2        2.00 dB
SFO2       299.8700000 MHz
NUC2       1H
SFO1       30.3909123 MHz
NUC1       15N
P3         6.50 usec
P15        3000.00 usec
PL12       2.00 dB
D3         0.00003000 sec

F2 - Processing parameters
SI         16384
SF         30.3967943 MHz
WDW        no
SSB        0
LB         0.00 Hz
GB         0
PC         0.10

1D NMR plot parameters
CX         20.00 cm
F1P        260.270 ppm
F1         7911.37 Hz
F2P        -432.809 ppm
F2         -13156.00 Hz
PPMCM      34.65393 ppm/cm
HZCM       1053.36853 Hz/cm
    
```

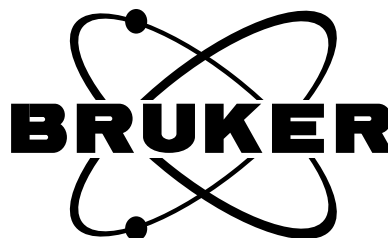
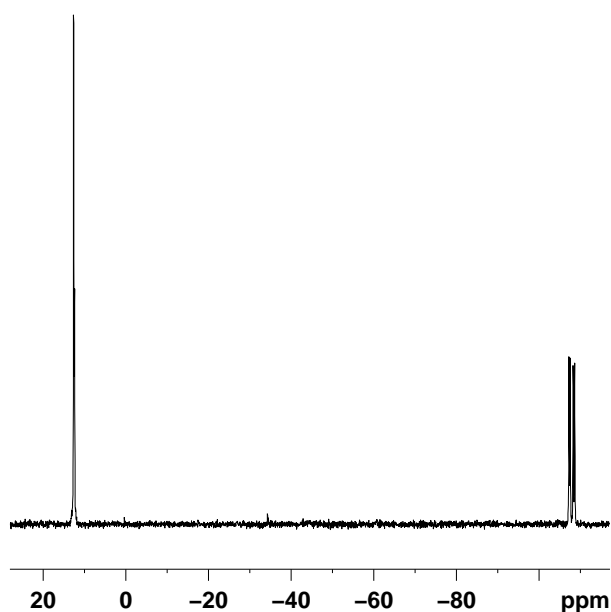
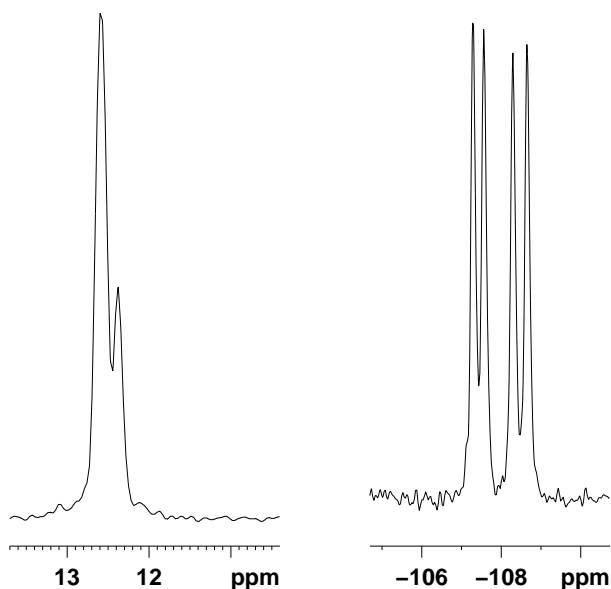

Figure 3.10. Si-29 resolution and sensitivity test of Q8M8



Q8M8 Si-29 CP/MAS reference spectrum
DSX 300, 4 scans, no LB, 57:1



Current Data Parameters

```

NAME      q8m8
EXPNO     1
PROCNO    1

F2 - Acquisition Parameters
Date_     950607
Time      9.56
INSTRUM   spect
PROBHD    5 mm Dual 13
PULPROG   cp.rel
TD         9370
SOLVENT   Aceton
NS         4
DS         0
SWH        31004.484 Hz
FIDRES     3.308910 Hz
AQ         0.1511572 sec
RG         1024
DW         16.127 usec
DE         23.04 usec
TE         300.0 K
PL1        10.00 dB
D1         10.00000000 sec
PL2        2.00 dB
SFO2       299.8700000 MHz
NUC2       1H
SFO1       59.5728356 MHz
NUC1       29Si
P3         6.50 usec
P15        10000.00 usec
PL12       2.00 dB
D3         0.00003000 sec

```

F2 - Processing parameters

```

SI         16384
SF         59.5753077 MHz
WDW        no
SSB        0
LB         0.00 Hz
GB         0
PC         0.10

```

1D NMR plot parameters

```

CX         20.00 cm
F1P        73.237 ppm
F1         4363.11 Hz
F2P        -148.050 ppm
F2         -8820.15 Hz
PPMCM      11.06437 ppm/cm
HZCM       659.16302 Hz/cm

```

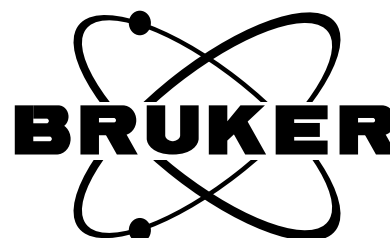

CP-MAS Experiments with WB Probes

Figure 3.11. Si-29 sensitivity test of DSS

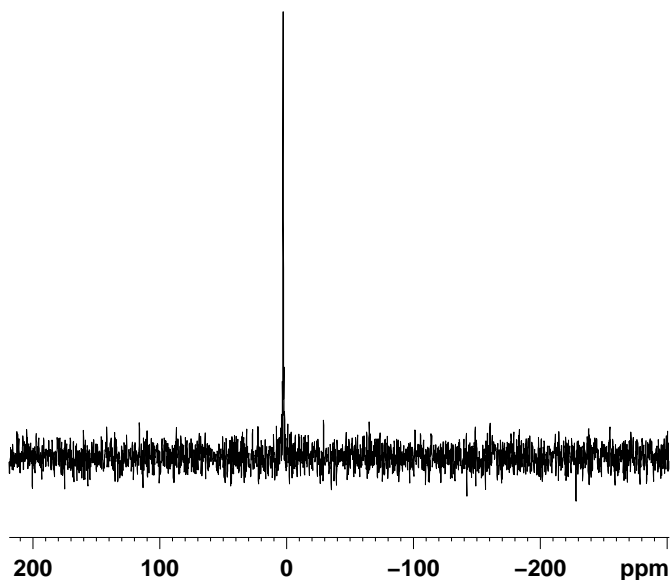

DSS, 3-(trimethylsilyl)-1-propanesulfonic acid sodium salt
Si-29 CP/MAS

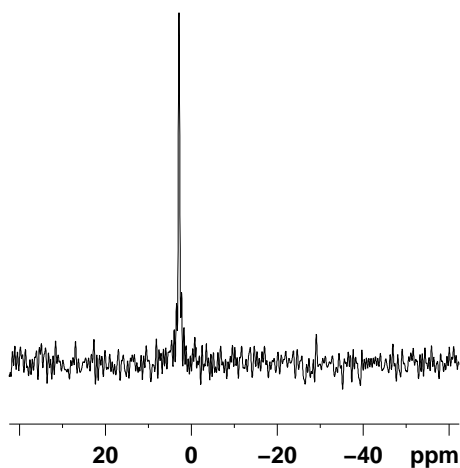

Current Data Parameters
NAME DSS
EXPNO 2
PROCNO 1

F2 - Acquisition Parameters
Date_ 950607
Time 10.29
INSTRUM spect
PROBHD 5 mm Dual 13
PULPROG vacp.rel
TD 2048
SOLVENT Aceton
NS 4
DS 0
SWH 31004.484 Hz
FIDRES 15.138908 Hz
AQ 0.0330775 sec
RG 1024
DW 16.127 usec
DE 23.04 usec
TE 300.0 K
PL1 10.00 dB
D1 10.0000000 sec
PL2 2.00 dB
SFO2 299.8700000 MHz
NUC2 1H
SFO1 59.5728356 MHz
NUC1 29Si
P3 6.50 usec
P15 1000.00 usec
SP0 1.50 dB
SPOFF0 0.00 Hz
SPNAM0 ramp.hf
PL12 2.00 dB
D3 0.00003000 sec

F2 - Processing parameters
SI 16384
SF 59.5753077 MHz
WDW no
SSB 0
LB 0.00 Hz
GB 0
PC 0.10

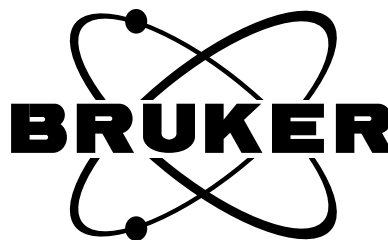
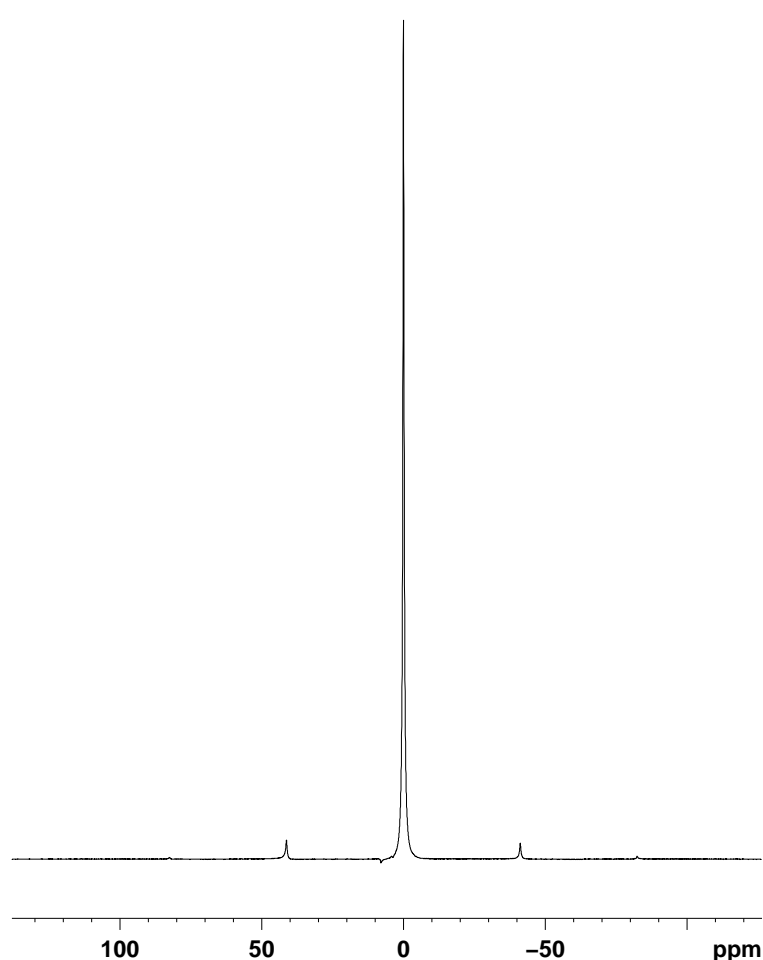

Figure 3.12. P-31 sensitivity test of ammonium dihydrogen phosphate, ADP, $\text{NH}_4\text{H}_2\text{PO}_4$



Ammonium dihydrogen phosphate,
P-31 CP/MAS reference sample
4 mm spinner, 4 scans, 4000:1
DSX 300

Current Data Parameters
NAME adp
EXPNO 1
PROCNO 1

F2 - Acquisition Parameters
Date_ 950607
Time 14.09
INSTRUM spect
PULPROG cp.rel
TD 4994
SOLVENT Aceton
NS 4
DS 0
SWH 50251.258 Hz
FIDRES 10.062326 Hz
AQ 0.0499900 sec
RG 128
DW 9.950 usec
DE 4.50 usec
TE 300.0 K
PL1 10.00 dB
D1 4.00000000 sec
PL2 2.00 dB
SFO2 299.8700000 MHz
NUC2 1H
SFO1 121.3894510 MHz
NUC1 31P
P3 4.00 usec
P15 1000.00 usec
PL12 2.00 dB
D3 0.00003000 sec

F2 - Processing parameters
SI 16384
SF 121.3889658 MHz
WDW no
SSB 0
LB 0.00 Hz
GB 0
PC 0.10

1D NMR plot parameters
CX 20.00 cm
F1P 210.982 ppm
F1 25610.84 Hz
F2P -202.987 ppm
F2 -24640.42 Hz
PPMCM 20.69844 ppm/cm
HZCM 2512.56299 Hz/cm

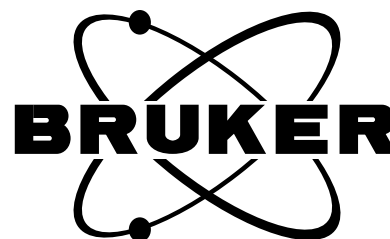
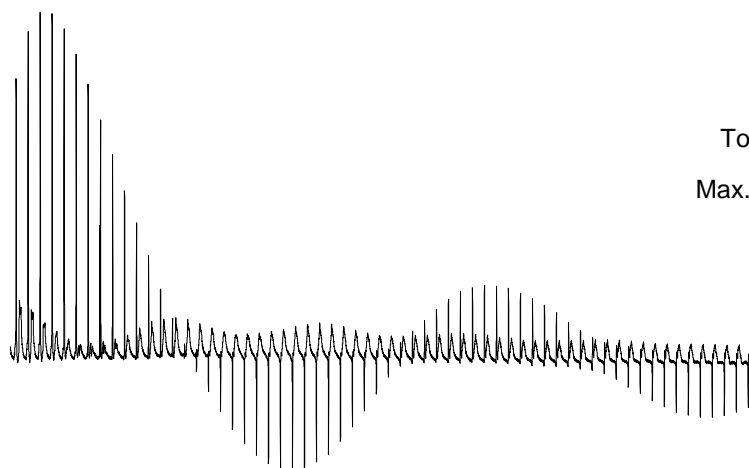

Figure 3.13. Comparison of pulse determination in a solid sample of YAG and in an aqueous solution of $Al(ClO_4)_3$

Pulse Determination For Odd Half Integer Quadrupolar Nuclei



Used sample: Y2 Al5 O12
Modified parameter : p1
Initial value : .3
Parameter increment: .3
Total number of experiments: 64

Max. intensity found at experiment 5.
p1 = 1.500000000

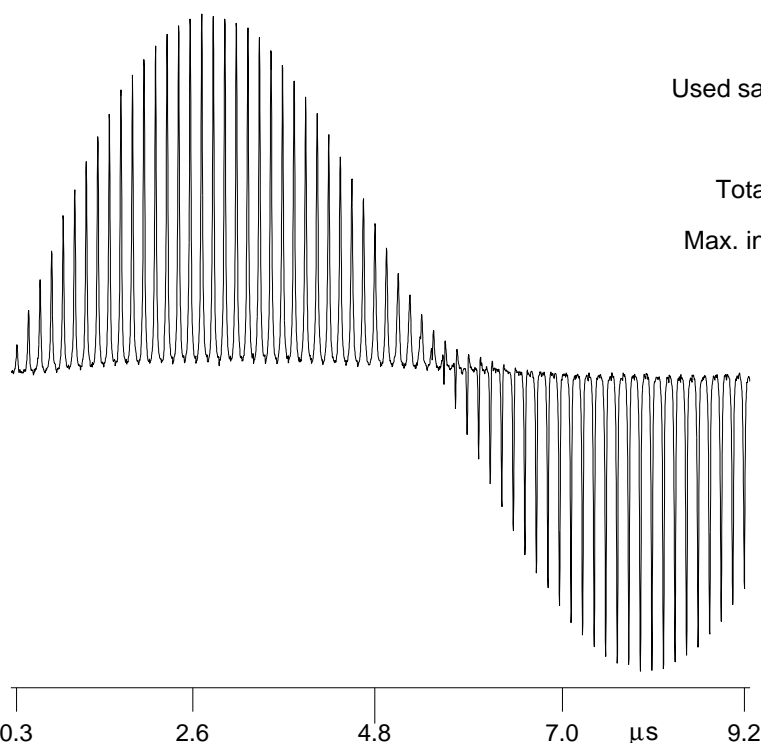

Used sample: Al-27 in aqueous solution
Modified parameter : p1
Initial value : .3
Parameter increment: .3
Total number of experiments: 64

Max. intensity found at experiment 17.
p1 = 5.100000000

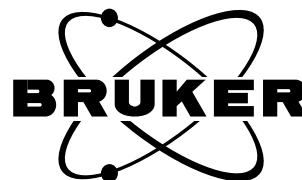

Figure 3.14. Processing parameter display (edp) showing the parameters to set up backward linear prediction

edp

Processing Parameters

SI	16384		PPARMOD	1D	
SF	75.4019443	MHz	OFFSET	343.819	ppm
SR	-396.70	Hz	HZpPT	1.895502	Hz
WDW	EM		SSB	0	
LB	20.00	Hz	GB	0	
PH_mod	no		PKNL	TRUE	
PHCO	17.579	degrees	PHC1	-463.200	degrees
BC_mod	quad		BCFW	1.000	ppm
FT_mod	fsc		FCOR	0.5	
ME_mod	no		COROFFS	0.00	Hz
NCOEF	100		LPBIN	2048	
ABSF1	10.000		ABSF2	0.000	ppm
ABSG	5		ABSL	3	
AZFE	0.100	ppm	AZFW	0.100	ppm
TDefF	0		TDoFF	-50	
STSR	0		STSI	0	

SAVE 1-COL Parameter Next CANCEL

CP-MAS Experiments with WB Probes

Figure 3.15. Comparison of fid's and spectra with and without treatment by backward linear prediction

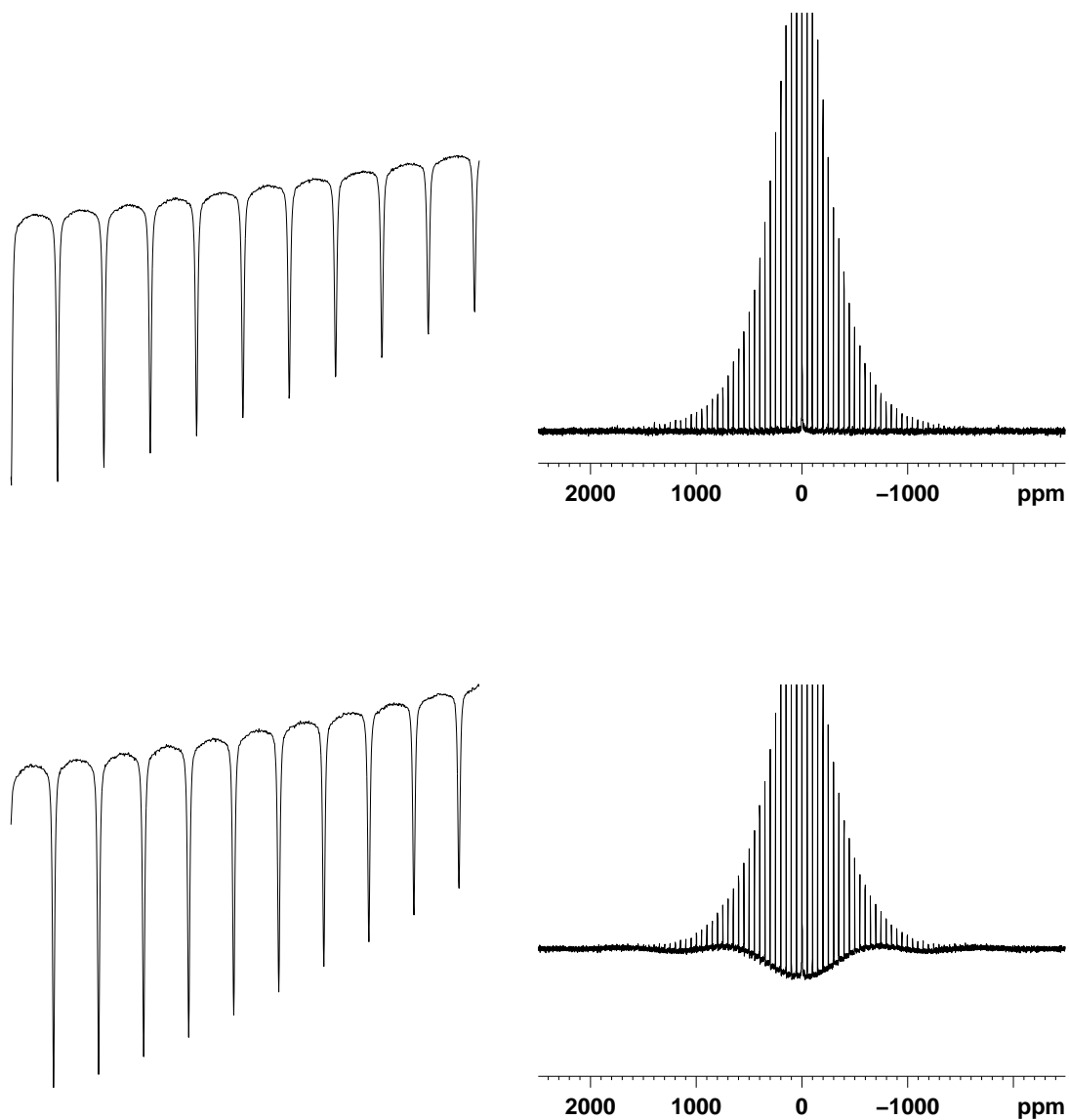

KBr MAS spectrum with (top) and without (bottom) linear backward prediction of first data points lost in the probe deadtime

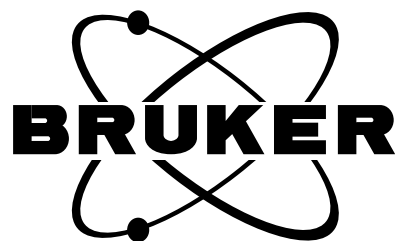

Advanced 1D and 2D Experiments

3.8

-not yet implemented-

MAS Automation

3.9

-not yet implemented

Wideline Experiments on DMX/DSX Instruments

4

Necessary equipment

4.1

Hardware:

4.1.1

For wideline experiments, the following equipment is required:

- Wideline probe for X range, for nuclei ^{109}Ag - ^{31}P
- Wideline probe for protons
- HP transmitter 1 kW
- HP preamplifier
- FADC
- Wideline glass tubes 10, 7.5 or 5 mm
- Spherical sample cells WILMAD 529 A

N.b.: Wideline spectroscopy covers line widths up to 500 kHz. Other probes than dedicated wideline probes or lower power amplifiers are not suitable for this purpose. With MAS probes, line widths up to 150 kHz can be observed with reduced performance (X-range only). With high resolution probes and transmitters, the line width limit is about 50 kHz with reduced performance. Running wideline experiment with lesser equipment than specified above is not specified and not part of any acceptance test unless specified in the sales contract.

Test samples:

4.1.2

For X-nucleus wideline setup:

- Powdered deuterated plexiglass
- D_2O
- Powdered sodium nitrate NaNO_3
- Ammonium chloride NH_4Cl
- Potassium chloride KCl

Wideline Experiments on DMX/DSX Instruments

- Powdered aluminium phosphate AlPO_4 , or other phosphate salts: watch out, since ammonium dihydrogen phosphate may have long piezoelectric ringing, and other phosphates have long T1 (60s).

For proton wideline setup:

- Distilled water
- Finely powdered gypsum with 1/2 crystal water, $\text{CaSO}_4 \cdot 0.5\text{H}_2\text{O}$

Hardware setup

4.2

The most important nucleus to observe in wideline experiments is deuterium. It is adequate to start the setup on deuterium.

Set up for deuterium observe in EDASP menu. Select HP transmitter and HP X-BB preamplifier. Tune transmitter with ppg txtest, find drive power level p1 to achieve > 1 kW of output power pulsing into 50 Ohm load with p1=100 u.

Optimize pulse shape with 2 usec pulses.

A pulse shape as below should be obtained:

Figure 4.1. Pulse Shape

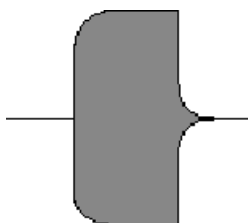

Store dataset h2hp 1 1 after get hpcu

Mount deuterium coil or insert into wideline probe, use Q=45 (high Q plugin may also be used if samples with line-widths <100 kHz are to be observed).

Before the actual NMR setup is started, the probe and system dead time should be measured: If no dedicated deuterium coil is available, use low range or high range coil.

- Load pulse program zg dead, set digtyp=FADC, swh 5e6, ns=1000, p1= 2u, d1=50 msec. Connect preamplifier to 50 Ohm load and accumulate with full transmitter power. Measure the number of points from the pulse rising edge to the point where the signal is at noise amplitude. Subtract the number of points that correspond to p1, calculate the dead time and note this as system dead time.

Then replace dummy load with empty probe and repeat test. Proposed dataset names are:

h2dead 1 1 and 2 1

N.b.: Fast digitizers require between 10 and 50 dwells depending on adc chip to reach a stable dc position, i.e. there will always be an „on resonance decay“ like curvature on the dc which, however, cancels on alternate scans. Nevertheless,

the adc should always be triggered well before the desired sampling point in echo experiments for reasons of finding the best echo top position.

- b. Load pulse program solidecho and repeat test with probe connected, with $d6=25$ μ s for 100 MHz instruments, 15 μ s for 200, 12 μ s for 300, 400, 500 MHz instruments, set $d7=d6-5$ μ s. Store as dataset 3 1. No substantial dead time should remain.

Experiment setup on 2H

4.3

In general, 5mm coils should be used for wideline experiments unless special reasons require larger diameters. The RF fields achieved in 7.5 or even 10 mm coils are substantially less than with 5 mm and do not allow to get similar spectrum quality as with 5 mm coils. In most cases, the signal to noise that is achieved in larger coils does not reflect the larger sample volume either. The following procedures refer to 5 mm coils with respect to achievable 90 degree pulse widths.

- a. Prepare a sample of D₂O in a spherical sample cell, filling the spherical part completely without air bubbles (Use syringe with needle <0.5 mm). Fix the sphere inside a high power tube, centering it in the middle of the RF coil (compare with mounted coil). Use paper or Teflon tape to form a suitable plug.

Figure 4.2. Preparing a Sample of D₂O in a Spherical Sample Cell



- b. Adjust sample tube in coil such that the sphere is in the center of the coil. Make sure it cannot move during probe insertion.
- c. Insert the probe and tune. Load pulse program ax, set $td=4k$, $swh=125e3$, digtyp SADC or HADC, $digmod=analog$, $fw=6e6$, $p1=1$ μ s, $d1=4s$, $l0=1$. Pulse in gs mode and shim for monoexponential decay. A trapezoidal shape should be obtained with a decay of about 50% under these conditions. If decay is multiexponential and shimming looks difficult, check sample for air bubbles. Shimming 50 Hz line width is usually sufficient and easy. With $O1=0$, use BSMS field adjustment to move FID precisely into resonance.
- d. Set power to give a 2-3 μ s 90 degree pulse (5 mm coil) (for line widths up to 500 kHz, use up to 1.3 kW power if available with low Q insert. With high Q insert, set p90 about 2.5-3 μ s). With 4-phase-modulator pulse program, xgain4 level is used for transmitter gain. Set $d1=1s$, $l0=32$ and optimize transmitter gain with FX amplitude $x=2048$ to get perfect amplitude tune pattern. Preferably use dot display in unshuffled mode. Set the receiver phase to have all signal in one audio channel (requires well adjusted quadrature). Try to get the center traces aligned into one line. A small „belly“ is legal, but the center lines should merge in the center towards the end.

Then reduce transmitter gains until the center traces split noticeably apart. Retune probe match and tune until the perfect pattern is achieved. Repeat until no more improvement is obtained. The probe should be optimized for glitch now. The tuning may be very different for low Q inserts, for high Q inserts there will be little difference. Check the tuning with wobb and remember the position of the dip. It should be to higher frequency, and

Wideline Experiments on DMX/DSX Instruments

substantially off match. (If a 4-phase modulator is present, it should now be completely adjusted as given in the CRAMPS test protocol). If the 4-phase-modulator pulse program is not used, nothing else needs to be adjusted. This CRAMPS-like adjustment will provide shorter pulses and better spectral symmetry.

- e. Prepare a sample of powdered d-plexiglass as shown below. Make sure the sample is not longer than the coil. Insert sample into coil center.

Figure 4.3. Preparing a Sample of Powdered D-plexiglass



- f. Load pulse program `solidecho`,

set `d6`= 25 μ for 100 MHz instrument,
15 μ for 200 MHz instrument,
12 μ for 300, 400, 500 MHz instrument,
set `d7`=`d6`-5 usec.

Set `digtyp`=FADC, `swh` 1e6, `d1`=5s, `td`= 4k, `ns`= 4-32 and `rg` depending on signal intensity.

Acquire `ns` scans, `ft` and set `o1` to the exact center between the 2 sharp lines. Pulse in GS mode, inspect FID in unshuffled mode and adjust receiver phase with HPCU receiver phase or with `phcor0` to have almost all signal in one of the audio channels. Acquire `ns` scans, inspect expanded FID to find the echo top, read via cursor position at what sampling point the echo top occurs and set `nsp`=this number of points. See fig. 4.4 for FID sampled before the echo top. Do `bc`, `ls`, `ft` (`datmod` set to processed data).

The 0 order phase correction should be close to 0, 90 180 or 270 degrees depending on the receiver phase, the first order should be close to 0 and the baseline should be almost straight. Check whether the two sharp signals are equally high (less than 5% deviation. If so, accumulate 512 scans with a spectral width `swh` of 5e6. Find the number of necessary left shifts to give the best spectrum. See fig. 4.5 for good spectrum of fully deuterated plexiglass.

Experiment setup for other nuclei

4.4

The probe should be tested at H-2, Na-23, P-31 and K-39 frequencies. If necessary, also N-14 should be tested if there is special interest in that nucleus. The system- and probe dead times should be tested similarly as for deuterium. The test spectra for K-39 in KCl and N-14 in NH₄Cl show easily detected narrow lines. The line width for P-31 in AlPO₄ is also no problem (see figs 4.6, 4.7, 4.8 for test spectra of K-39, P-31, N-14). The test spectrum for NaNO₃ however requires some effort.

- a. Prepare a sample tube with finely powdered NaNO₃ as shown above.

- b. Set up for Na-23 observation with low Q insert. Run spectrum with zgadc, digt-yp=FADC, swH 1e6, d1= 10s. Set O1 on resonance. Set power to give 4-5 usec 90 degree pulse on narrow line (5 mm coil). Load pulse program solideocho, set p1= half of p90. Acquire 128 scans at swH 5e6, d1=20s with d6=8 usec, d7 3 usec. Find echo top and left shift appropriately to obtain small phase corrections. Compare fig. [4.9](#) for reference.

Proton wideline probes require the transmitter setup and probe tuning as for deuterium or for CRAMPS. The test spectrum will be acquired on the gypsum test sample with the following conditions: ppg=solideocho, ns=16, d1=10s, d6=6 usec, d7=3 usec, swH=1e6, td=4k. See fig. [4.10](#) for reference.

General Setup Considerations

4.5

The wideline probe comes with a set of inserts and a set of at least 2 coils. This set of inserts allows to choose high Q or low Q operation perhaps with several different coils. What combination should be chosen? Usually, one wants to get as high sensitivity as possible. However for wideline probes, a specification of sensitivity (signal to noise) makes no sense at all, since the highest priority probe parameters are dead time and pulse width. The dead time that is allowed depends on the sample to be measured, this requires a certain Q-value and hence the pulse length that can be achieved with available transmitter power is given. It is obvious that a compromise must be achieved between spectral quality and measurement time. There is little range for improvement in one respect that has no negative effect on the other. The only effective way of optimizing both spectral quality and signal to noise is to optimize the coil geometry with respect to filling factor. In general, 5 mm coils are better in every respect. Larger diameters should only be selected if the sample shape requires this. There is, however, another problem to be considered, which in some cases renders the previous considerations useless: acoustic ringing.

Acoustic or piezoelectric ringing may give rise to signals that are much larger and have a much longer „T2“ than the desired sample signal. Such problems can only to a limited degree be avoided by design and construction principles, since the frequency of acoustic ringing phenomena can occur within very wide ranges, and can shift with very subtle differences in construction from a location where nobody will notice into a range that makes observation of a nucleus impossible. Also, there is no bench test for acoustic ringing since a magnet is required. Acoustic ringing problems can only be solved in the final test phase or after installation. In general, ringing problems are to be expected for massive wire coils at low frequencies in high field magnets. In practice, considering the main nuclei of interest, deuterium and all nuclei below are problematic in fields 300 MHz (46 MHz) and below. In a field of 400 MHz, the 61 MHz deuterium frequency already cause less problems due to the higher frequency. Na-23 is usually no problem any more even at 200 MHz. To avoid misinterpretation: a spectrum at 4 MHz is more difficult in a 500 MHz instrument than in a 100 MHz, but to get a Fe-57 spectrum is easier in 500 than in a 100 MHz instrument.

The best setup for wideline measurements should be found as follows:

1. What is the NMR frequency and intrinsic sensitivity?

Wideline Experiments on DMX/DSX Instruments

If abundance <5% and frequency < 2H: expect problems unless lines are narrower than 10 kHz

If abundance >10% and frequency > 2h: usually no problem unless lines are prohibitively wide (> 500 kHz). In between:?

2. What line widths are to be expected?
 - > 200 kHz: 5 mm coil, low Q
 - <200 kHz, but >100 kHz, low Q, coil 5, 7.5 or 10 mm
 - > 50 kHz, but < 100 kHz high Q insert, coil 5, 7.5 or 10 mm
 - <50 kHz almost anything will do

3. What information is required
 - full lineshape analysis required: prefer smaller coil and lower Q
 - quadrupolar or dipolar splitting only: higher Q, larger coil may do.

4. Refer to the test data sheets in order to find out whether an acoustic ringing problem exists for the selected frequency/coil/insert combination. If necessary, test „adjacent“ possibilities if prohibitive ringing exists.

5. If ringing problems are prohibitive, ask for advice from solids applications specialists. Probe test sheets with dead time data have been completed upon installation at least for the specified nuclei, and for other nuclei on request.

Figure 4.4. FID of deuterated plexiglass, quadecho experiment, sampled before echo top

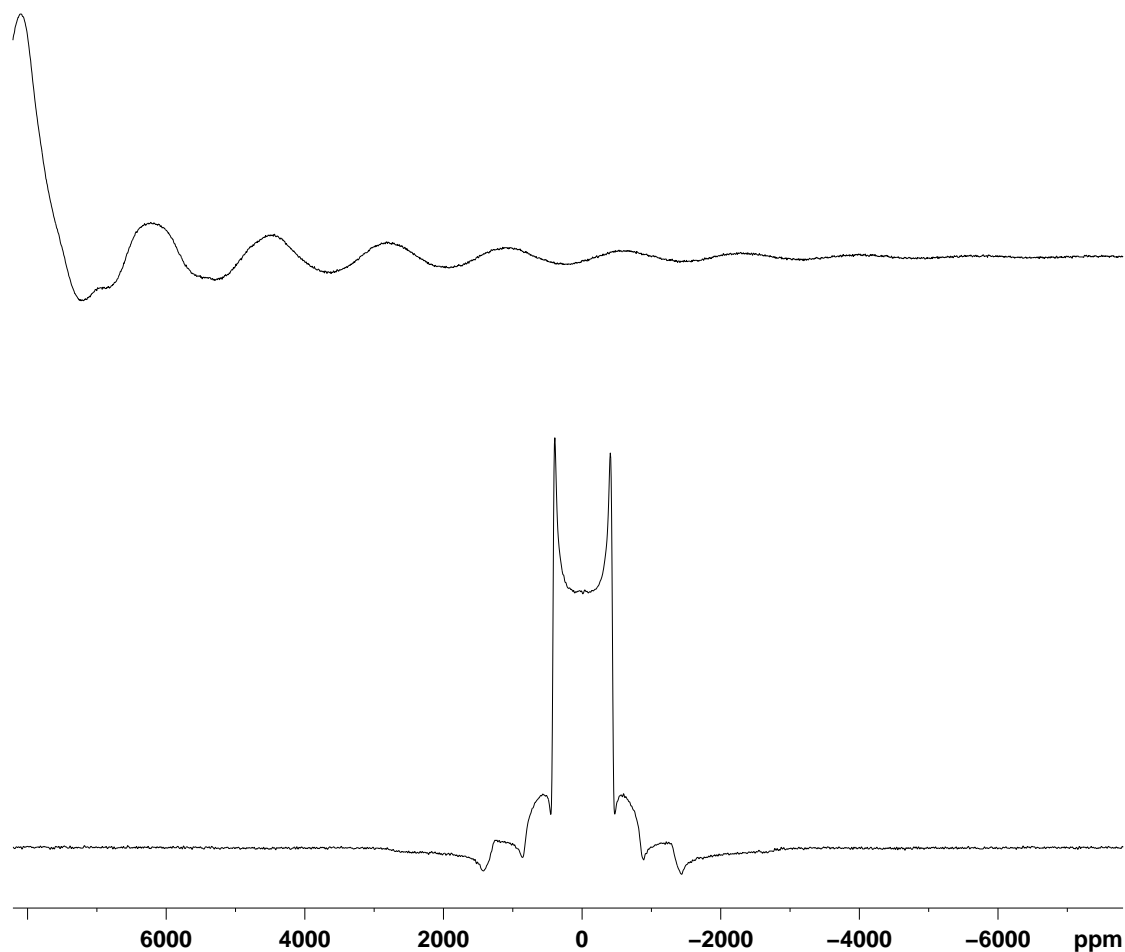

deuterated plexiglass, 2H wideline spectrum
top:
FID as sampled before echo top
bottom:
FT without left shifts

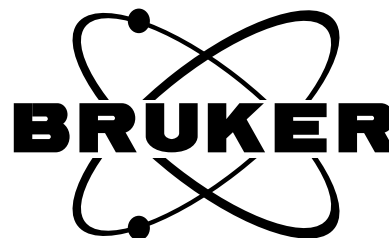

Wideline Experiments on DMX/DSX Instruments

Figure 4.5. Spectrum of deuterated plexiglass, left shifted appropriately

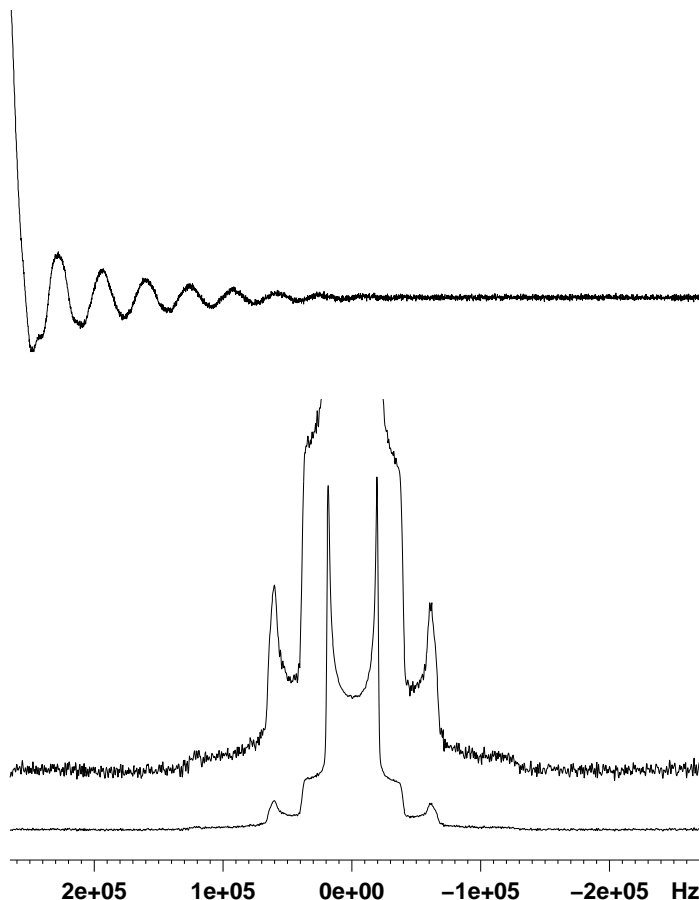

Deuterated plexiglass, 2H wideline spectrum
 top:
 first part of FID, left shifted to echo top
 bottom:
 spectrum with left shifts to top of echo

```

Current Data Parameters
NAME      dplexax1000
EXPNO     3
PROCNO    1

F2 - Acquisition Parameters
Date_     950912
Time      16.15
INSTRUM   spect
PROBHD    5 mm Dual 13C/1H
PULPROG   solidecho.rel
TD         8192
SOLVENT   CDCI3
NS         256
DS         0
SWH        5000000.000 Hz
FIDRES     610.351562 Hz
AQ         0.0008692 sec
RG         4096
DW         0.100 usec
DE         4.50 usec
TE         300.0 K
PL1        3.00 dB
D1         5.00000000 sec
SFO1       46.0318710 MHz
NUC1       2H
P1         2.20 usec
D6         0.00001200 sec
D7         0.00000300 sec

F2 - Processing parameters
SI         16384
SF         46.0321741 MHz
WDW        no
SSB        0
LB         0.00 Hz
GB         0
PC         1.00

1D NMR plot parameters
CX         20.00 cm
F1P        5430.984 ppm
F1          249999.98 Hz
F2P        -5430.984 ppm
F2         -249999.98 Hz
PPMCM      543.09839 ppm/cm
HZCM       25000.00000 Hz/cm
    
```

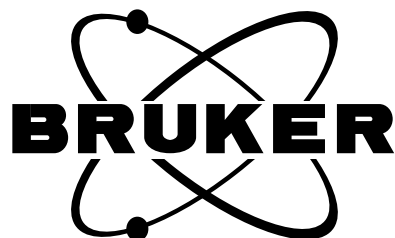
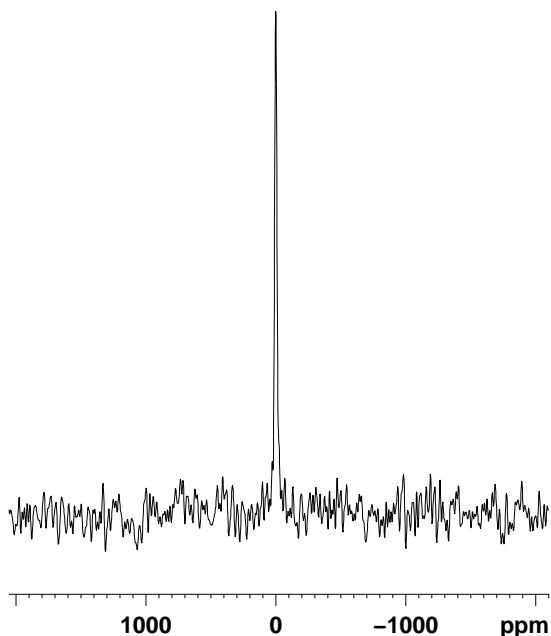

Figure 4.6. K-39 in KCl



KCl, K-39 wideline test, 5mm coil, low Q, 20s recycle
DSX 300

Current Data Parameters

NAME kcl
EXPNO 1
PROCNO 1

F2 - Acquisition Parameters

Date_ 950612
Time_ 13.42
INSTRUM spect
PULPROG zgadc.rel
TD 4096
SOLVENT Aceton
NS 3
DS 0
SWH 125000.000 Hz
FIDRES 30.517578 Hz
AQ 0.0164340 sec
RG 1024
DW 4.000 usec
DE 5.71 usec
TE 300.0 K
PL1 6.00 dB
D1 20.00000000 sec
SFO1 13.9936480 MHz
NUC1 39K
P1 6.00 usec
D3 0.00010000 sec

F2 - Processing parameters

SI 4096
SF 13.9936479 MHz
WDW EM
SSB 0
LB 100.00 Hz
GB 0
PC 0.10

1D NMR plot parameters

CX 20.00 cm
F1P 4466.312 ppm
F1 62500.00 Hz
F2P -4466.312 ppm
F2 -62500.00 Hz
PPMCM 446.63120 ppm/cm
HZCM 6249.99951 Hz/cm

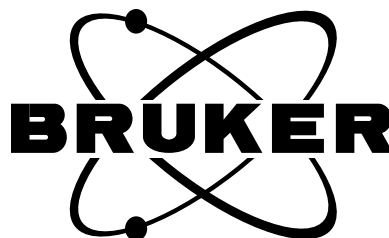

Wideline Experiments on DMX/DSX Instruments

Figure 4.7. P-31 in AIPO4

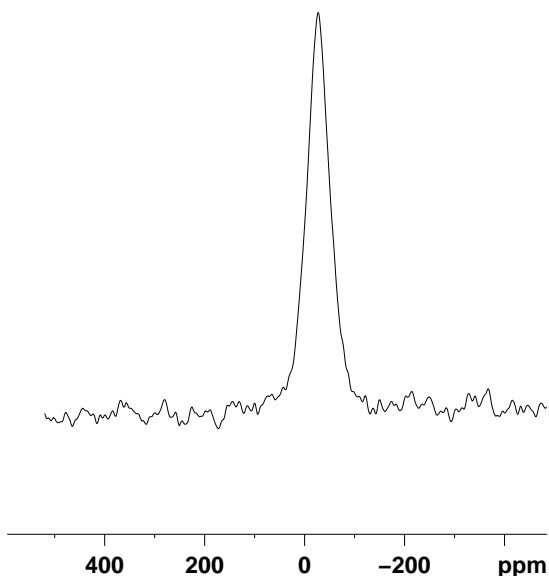

AIPO4 P-31 wideline spectrum, 5 mm coil, low Q
8 scans, 30s recycle delay
DSX 300

Current Data Parameters
NAME alpo4
EXPNO 1
PROCNO 1

F2 - Acquisition Parameters
Date_ 950612
Time_ 11.15
INSTRUM spect
PULPROG zgadc.rel
TD 256
SOLVENT Aceton
NS 8
DS 0
SWH 125000.000 Hz
FIDRES 488.281250 Hz
AQ 0.0010740 sec
RG 1024
DW 4.000 usec
DE 5.71 usec
TE 300.0 K
PL1 10.00 dB
D1 30.00000000 sec
SFO1 121.3894510 MHz
NUC1 31P
P1 3.00 usec
D3 0.00000500 sec

F2 - Processing parameters
SI 1024
SF 121.3889658 MHz
WDW EM
SSB 0
LB 1000.00 Hz
GB 0
PC 0.10

1D NMR plot parameters
CX 20.00 cm
F1P 518.871 ppm
F1 62985.20 Hz
F2P -510.877 ppm
F2 -62014.80 Hz
PPMCM 51.48738 ppm/cm
HZCM 6249.99951 Hz/cm

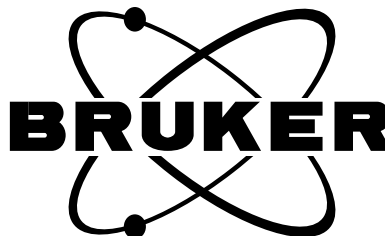
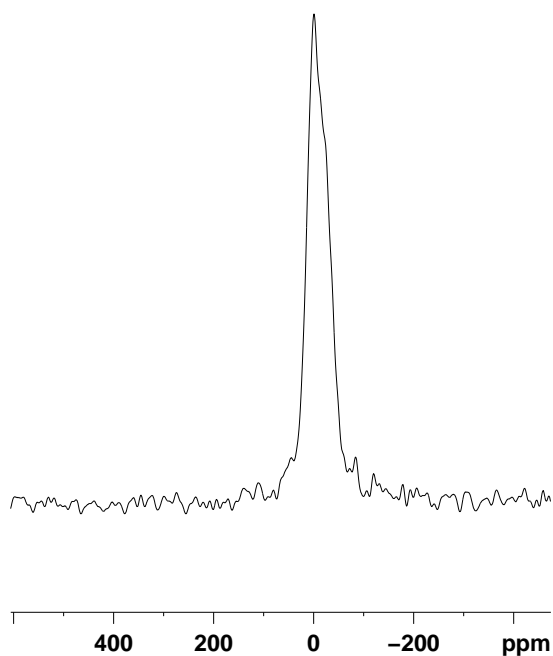

Figure 4.8. N-14 in NH4Cl



NH4Cl, N-14 wideline test, 5 mm coil, low Q, 4s recycle
DSX 300

Current Data Parameters

NAME nh4cl
EXPNO 1
PROCNO 1

F2 - Acquisition Parameters

Date_ 950612
Time 11.51
INSTRUM spect
PULPROG zgadc.rel
TD 1024
SOLVENT Aceton
NS 8
DS 0
SWH 125000.000 Hz
FIDRES 122.070312 Hz
AQ 0.0041460 sec
RG 1024
DW 4.000 usec
DE 5.71 usec
TE 300.0 K
PL1 10.00 dB
D1 5.00000000 sec
SFO1 21.6617270 MHz
NUC1 14N
P1 5.00 usec
D3 0.00000500 sec

F2 - Processing parameters

SI 4096
SF 21.6621288 MHz
WDW EM
SSB 0
LB 100.00 Hz
GB 0
PC 0.10

1D NMR plot parameters

CX 20.00 cm
F1P 2866.669 ppm
F1 62098.15 Hz
F2P -2903.771 ppm
F2 -62901.85 Hz
PPMCM 288.52197 ppm/cm
HZCM 6250.00000 Hz/cm

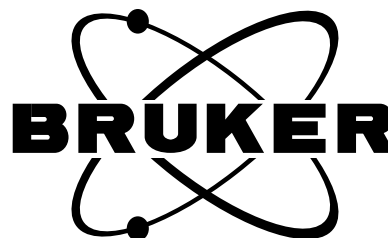
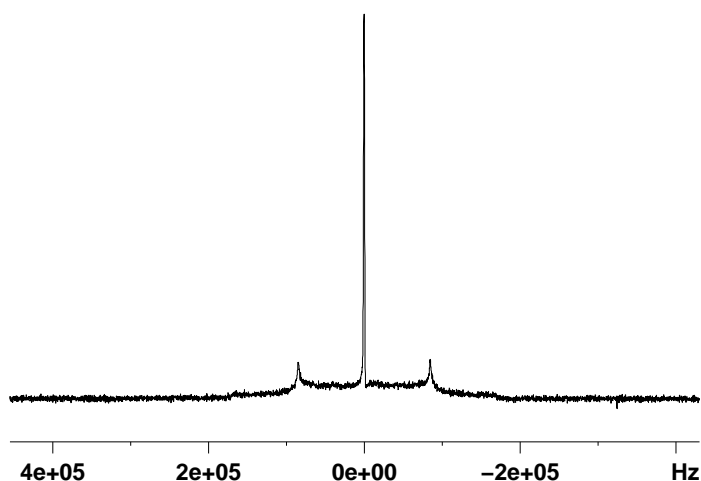
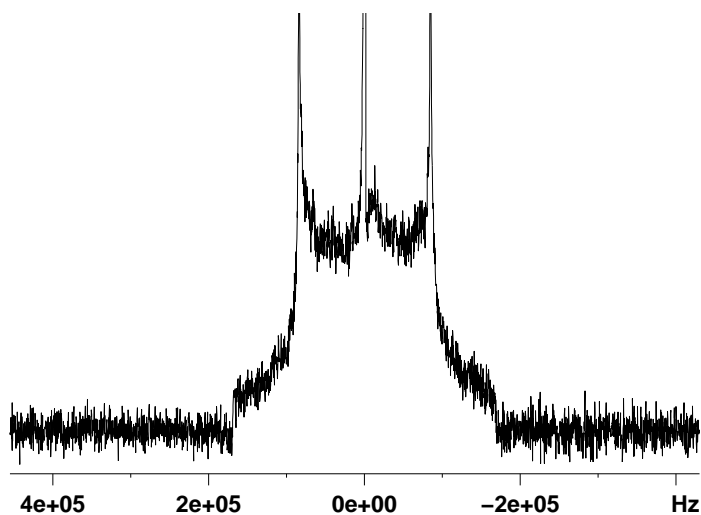

Figure 4.9. Na-23 in NaNO3



Current Data Parameters
 NAME nano3
 EXPNO 5
 PROCNO 1

F2 - Acquisition Parameters
 Date_ 960306
 Time 9.20
 INSTRUM spect
 PROBHD MAS 4 mm
 PULPROG solidecho.rel
 TD 16384
 SOLVENT CDCI3
 NS 15
 DS 0
 SWH 1000000.000 Hz
 FIDRES 61.035156 Hz
 AQ 0.0082420 sec
 RG 512
 DW 0.500 usec
 DE 4.50 usec
 TE 300.0 K
 PL1 10.00 dB
 D1 20.00000000 sec
 P1 2.30 usec
 SFO1 79.3242557 MHz
 NUC1 23Na
 D6 0.00001500 sec
 D7 0.00000300 sec

F2 - Processing parameters
 SI 16384
 SF 79.3241946 MHz
 WDW no
 SSB 0
 LB 0.00 Hz
 GB 0
 PC 1.00

Na-23 wideline spectrum, quadecho sequence
 pulse width optimized for satellite transition

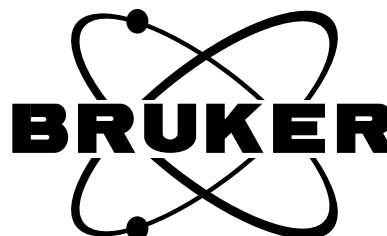
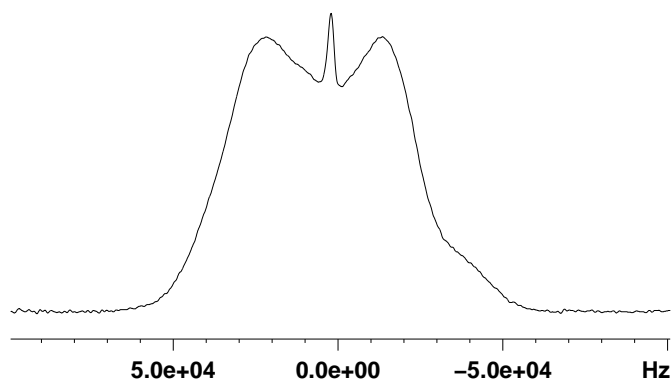

Figure 4.10. H-1 in gypsum powder



Current Data Parameters

NAME gips
EXPNO 1
PROCNO 1

F2 - Acquisition Parameters

Date_ 930426
Time 16.37
INSTRUM asx500
PROBHD 09
PULPROG echocycl.ste
TD 4096
SOLVENT field0
NS 1
DS 0
SWH 1000000.000 Hz
FIDRES 244.140625 Hz
AQ 0.0175730 sec
RG 1024
DW 0.500 usec
DE 4.50 usec
TE 300.0 K

F2 - Processing parameters

SI 4096
SF 500.1281940 MHz
WDW no
SSB 0
LB 0.00 Hz
GB 0
PC 1.40

gypsum powder, 1H wideline spectrum
quadecho sequence
sharp peak is adsorbed water, broad
line is crystal water
asymmetry comes from chemical shift
difference between 2 water protons

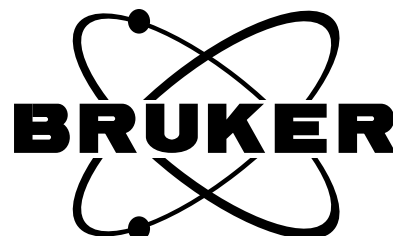

CRAMPS

Experiments on

DMX/DSX

Instruments

5

Necessary equipment

5.1

Hardware:

5.1.1

- CRAMPS probe 4 mm or 7 mm with CRAMPS spinners
- 1H HP transmitter
- 1 dB attenuator MSL style
- 1H/19F/3H HP- HP preamplifier
- spherical sample cell, WILMAD GLASS Co. No. 529A
- TCU with 4k RAM, H5811
- FCU EC level 6 or higher

Software:

5.1.2

- above hardware can only be driven with xwin- nmr versions (95 release).

Test samples:

5.1.3

- distilled water
- finely powdered glycine
- finely powdered adamantane
- (not essential) finely powdered malonic acid, citric acid or adipic acid
- finely powdered barium chlorate monohydrate
- take care, do not mix with organic substances, the mixture may possibly explode

It is recommended to store every setup step as a separate data set on disk with HPCU settings retrieved with gethpcu.

Refer to the different sections for recommended names.

- a. Prepare a spinner cap such that the neck of the spherical sample cell will fit through the hole. Shorten the neck of the sample tube so it will stick out less than 2 mm through cap as shown in picture (7mm spinners only).

- b. Use a syringe with needle diameter < 0.5 mm to fill the spherical part of the cell with water. Make sure there is no air bubble inside. A little bit of water in the neck is no problem. It is difficult to avoid air bubbles once the neck is wet inside, so remove air in the syringe and dry needle before slowly pressing the water in. Prepare CRAMPS spinner as shown (7mm spinners).

Figure 5.1. 7mm spinner preparation

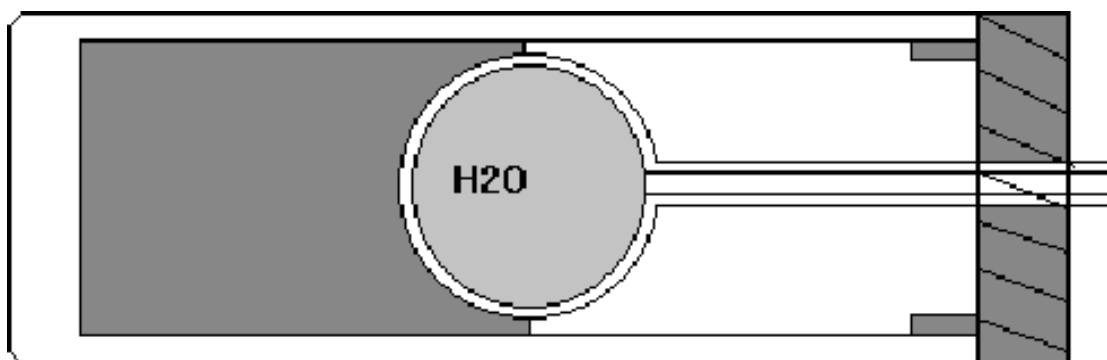
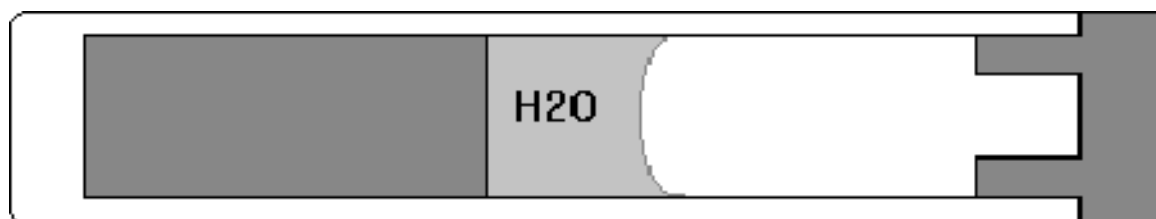

Figure 5.2. 4mm spinner preparation



For 4mm CRAMPS probes, a CRAMPS spinner with lower spacer should be prepared in the following way: Use syringe to introduce just a drop of water to provide a 3mm high water cylinder in the center. Do not fill too high. Keep spinner upright. The preparation will not last for long. After sample eject there will most probably be a bubble inside, so it is wise to have a second sphere handy.

- a. Load pulse program txtest, setup for HP proton observation. Pulse into 50 Ohm load, tune for highest power first, optimize drive power level pl1. With 2 usec pulses, 2usec d3 pulse optimize transmitter pulse shape with transmitter input and output tuning until a good pulse shape as close as possible to the picture below is obtained.

Figure 5.3. Good Pulse Shape

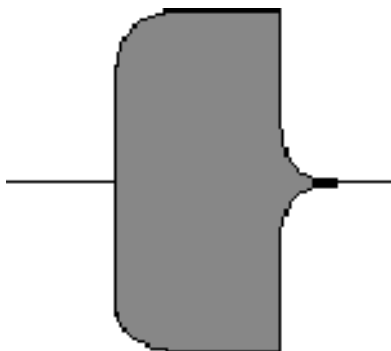

This pulse shape should be easily achieved with 200 or 300 MHz transmitters. With cavity transmitters, a small overshoot in the rising edge is normally observed.

- b. For CRAMPS type experiments, the edscon parameters for channel 2 must be modified. Try what value for BLKTR is necessary. Pulse rise time should be ok with 0.7- 1 usec. Set PHASPR to 0.25- 0.35 for 4- PM phase shifts. Set BLKPR to 1usec. If DDS phase shifts are used, set PHASPR to 1 usec. Connect transmitter output to HP preamplifier through a 1 dB attenuator.
- c. For CP probes, tune magic angle on KBr, for CRAMPS probes, insert spinner with barium chlorate, observe proton FID with 1 usec pulses, optimize sideband pattern like for KBr, spinning at 5 kHz (see fig. 5.4 for reference). Store as baclo3 1 1.
- d. Insert the prepared water sample into probe and tune. Load pulse program ax, set td=4k, swh=125e3, digtyp SADC or HADC, digmod=analog, fw=6e6, p1=1usec, d1=4s, l0=1. Pulse in gs mode and shim for monoexponential decay. A trapezoidal shape should be obtained with a decay of about 50% under these conditions. If decay is multiexponential and shimming looks difficult, check sample for air bubbles. Shimming is generally easy. With O1=0, use BSMS field adjustment to move FID precisely into resonance. Store as shimcramps 1 1.
- e. Set power to give a 1.6- 1.8 usec 90 degree pulse on CRAMPS probes, 2usec on CP 4 mm probes and 2.2 usec on CP 7 mm probes. With 4- phase- modulator pulse program, hgain4 level is used for transmitter gain. Set d1=1s, l0=32 and optimize transmitter gain with FH amplitude x=2048 to get perfect ampli-

tude tune pattern. Preferably use dot display in unshuffled mode. Set the receiver phase to have all signal in one audio channel (requires well adjusted quadrature). See fig. [5.5](#) for perfect pattern. Try to get the center traces aligned into 1 line. A small „belly“ is legal, but the center lines should merge in the center towards the end.

Then reduce transmitter gains until the center traces split noticeably apart. Retune probe match and tune until the perfect pattern is achieved. Repeat until no more improvement is obtained.

The probe should be optimized for glitch now. The tuning may be very different for low Q CRAMPS probes, for high Q CP probes there will be little difference. Check the tuning with wobb and remember the position of the dip. It should be to higher frequency, and substantially off match. Adjust the 4- phase modulator amplitudes for all phases, leaving the transmitter gain the same. Pulse programs are amx, ay, amy. The pattern must be the same for all 4 pulse phases except for the phase. Then adjust the phases with pulse programs pmx, py, pmy. In every case, the signal should be parallel lines with no signal in one audio channel (see figs. [5.5](#) for perfect patterns). With pulse program pxmx, check for the glitch. Ideally, two parallel straight lines should be obtained. In practice, no more than the first quarter of a sine should be seen. If not, try to straighten the lines by probe tuning and matching (see figs. [5.6](#), [5.7](#), [5.8](#)).

For setup with DDS phase shifter, axdds should be used. Only the amplitude must be set using the transmitter gain or pl1 with cavity transmitters (400/500/600 MHz). The glitch test pulse program is then pxmxdds. (See fig. [5.8](#) for perfect pattern). Separate data files should be stored as ax 1 1. amx 1 1 and so on.

f. Load pulse program mrev8 (mrev8dds), set d3=3.5 usec for CRAMPS probes, 4.5 usec for CP probes, td=1k, digmod=analog, digtyp=SADC or HADC, aqmod=qsim, dw=6*d3/2.1, reset fw to 6e6, p0=1u, and run 4 scans (d1=4s). The signal should be off center by no more than 500 Hz (CRAMPS probe) or 1000 Hz (CP probe). Store as mrevh2o 1 1

g. The offset measures the residual asymmetric phase glitch that results in a frequency offset. If a larger offset is obtained, try to improve transmitter and probe tuning with pulse program pxmx or pxmxdds. If the FID shows a fast initial decay for about 100- 200 data points, then a slow decay, replace preamp multiplexer diodes.

This operation must be done by an authorized BRUKER service engineer. The desired pattern is shown in fig. [5.9](#). With the water sample still acquire two FIDs with the offset o1 varying from 0 to +/- 4000Hz with 1000 Hz steps. Do 4 scans each, start acquisition with go on offset 1000- 4000 Hz (see fig. [5.10](#)). The tallest line shows the best offset frequency to use, the line separation allows you to recalculate swH to give 1000 Hz peak separation. Reset swH by typing 2s swH <new value>, then ft to check. Set swH to the found value and reset fw to 6e6. Store as mrevoffset 1 1

h. Make up new data set and repeat calibration with ppg br24. In this case, the dw should be set to $18 \cdot d3/2.5$. For quad detected br24, quadimage suppression and center spike suppression need to be optimized. Set $p4=p1 \cdot 55/90$ (magic angle pulse). Pulse in gs mode and optimize p4 and phcor4 curvature of FIDs in unshuffled mode unfid on resonance decay is minimum. Phcor4 should be such that the total phase shift on phase 4 is 220- 240 degrees. Store as br24h2o 1 1. Adjust swh to give 1000 Hz peak separation. Store as br24offset 1 1 (fig. [5.10](#)). Refer to next para if signal does not look sensible (dead time too long).

i. Check probe tuning with wobb, remember dip position. Replace spinner with CRAMPS spinner containing powdered glycine. Spin 1800- 2200 Hz. Check probe tuning with wobb. CRAMPS probes should be very close to previous setting. CP probes will be off. Use tune knob only to retune to previous dip position. Check for spinner wobble visible as modulations on wobble signal (slight wobble is tolerable).

With mrev8 data set and suitable offset O1 do 4 scans. The high field peak should be noticeably split. Use dot display in un- shuffled mode to observe the 2 audio signals. Every FID will have two signals offset vertically. This offset represents deadtime that is sampled. If this offset cancels after 4 scans and if it is small compared to the real signal, this is ok. Else the delay d3 must be lengthened at the cost of resolution, or the probe Q must be reduced. If this offset is large and remains even when the probe is replaced by a 50 Ohm load, the receiver pathway reducer introduces deadtime. Check whether the audio filter is fully open (fw=6e6).

Store as mrevgly 1 1 (see fig. [5.11](#) for comparison).

j. Load br24 data set and check resolution. The baseline between the peaks should be lower and the splitting of the high field peak should be better. Optimize offset, transmitter gain, p1 for best resolution. Carefully retune probe pulsing in gs mode for best resolution. Reoptimize p4 and phcor4 for minimum center spike after 4 scans. Store as br24gly 1 1 (see fig. [5.12](#), [5.13](#), [5.14](#), [5.15](#))

k. Insert CRAMPS spinner with adamantane, pulse in gs mode (d1=4s, td 1k) and shim on the FID (gradients z, z2, z3,x y). Store as br24adam 1 1. Save shims. Then repeat glycine test (j). Refer to the spec sheet to check performance. Calibrate position between alpha protons to 3.5 ppm. The low field line should be around 6.5- 7 ppm. If necessary, repeat swh calibration with water.

l. To apply digital filtering, just set digmod=digital. Then td must be reduced to the required minimum to avoid overly long pulse trains. Reset fw to 6e6. The shift calibration will be off and has to be readjusted with 2s swh prior to fourier transformation. With digital filtering and a given decimation factor, it is not possible to preset SWH to an appropriate value. (See fig. [5.16](#))

Figure 5.4. MAS spectrum of BaClO₃*H₂O, 5 kHz rotation

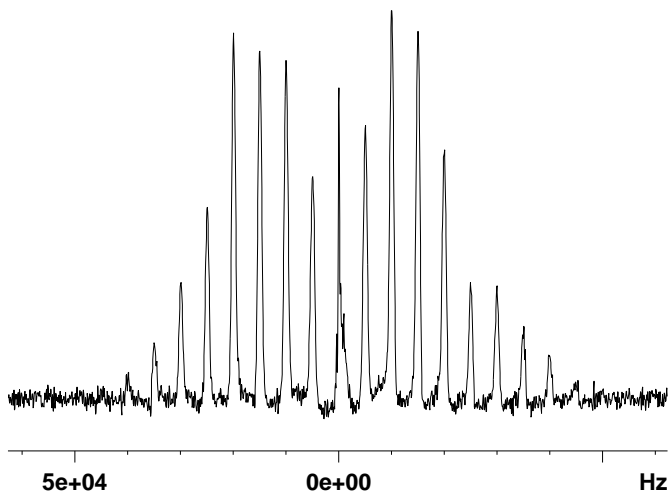

```

Current Data Parameters
NAME      baclo3
EXPNO     1
PROCNO    1

F2 - Acquisition Parameters
Date_     951010
Time      11.19
INSTRUM   spect
PROBHD    5 mm Dual 13
PULPROG   zgadc.rel
TD         1024
SOLVENT   CDCl3
NS         4
DS         0
SWH       125000.000 Hz
FIDRES    122.070312 Hz
AQ         0.0041460 sec
RG         32
DW         4.000 usec
DE         5.71 usec
TE         300.0 K
PL1        1.15 dB
D1         4.00000000 sec
SFO1      299.8700000 MHz
NUC1       1H
P1         1.75 usec
D3         0.00001000 sec

F2 - Processing parameters
SI         2048
SF         300.1299897 MHz
WDW        no
SSB        0
LB         0.00 Hz
GB         0
PC         1.00
    
```

1H--MAS spectrum of BaClO₃,
 proton background removed by linear backward prediction
 spin rate 5 kHz
 DSX 300

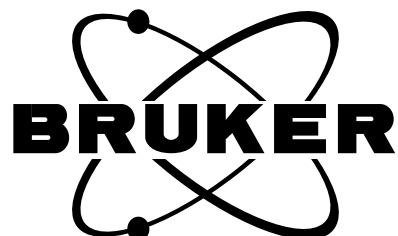
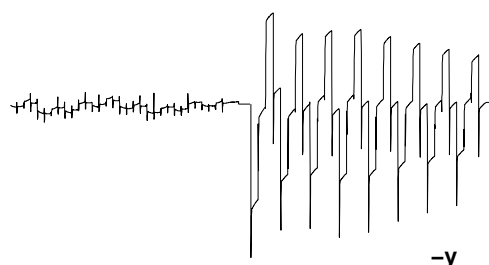
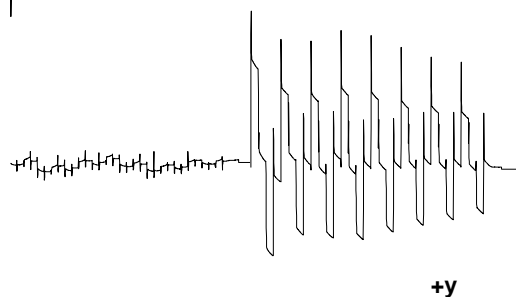
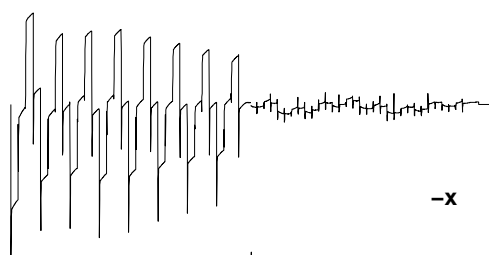
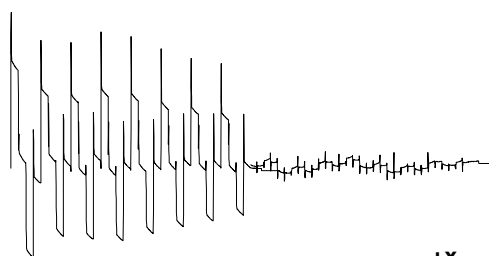

Figure 5.5. Amplitude tune pattern



Current Data Parameters

```
NAME      amx
EXPNO     1
PROCNO    1
```

F2 - Acquisition Parameters

```
Date_     960716
Time      9.42
INSTRUM   spect
PROBHD    MAS 4 mm
PULPROG   amx.rel
TD        4096
SOLVENT   CDCl3
NS        1
DS        8
SWH       125000.000 Hz
FIDRES    30.517578 Hz
AQ        0.0164340 sec
RG        32
DW        4.000 usec
DE        5.71 usec
TE        300.0 K
L0        32
obs       0.0004823 sec
PL1       5.15 dB
D1        2.00000000 sec
SFO1      400.1300000 MHz
NUC1      1H
P1        1.80 usec
```

F2 - Processing parameters

```
SI        4096
SF        300.1299897 MHz
WDW       no
SSB       0
LB        0.00 Hz
GB        0
PC        1.00
```

Amplitude tune patterns,
from top:
+x, -x, +y, -y
with $i0=32$
with receiver phase set
for zero signal in one
audio channel

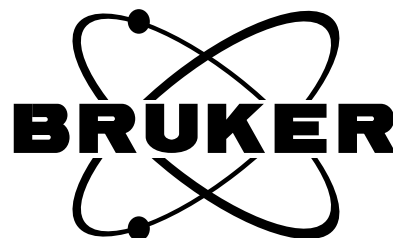
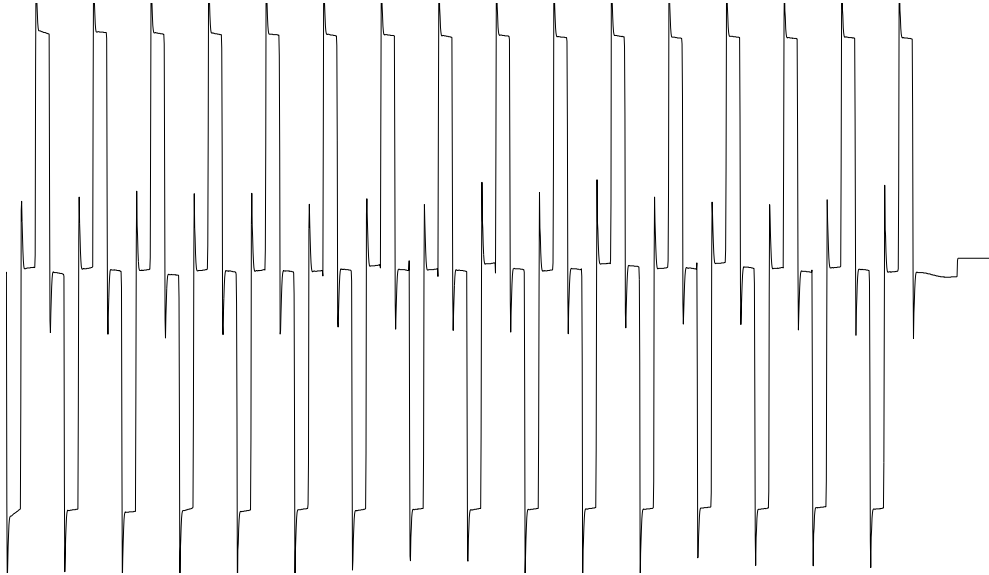

Figure 5.6. Tune pattern for -x phase



Tuneup sequence for -X phase
second audion cahnnel not shown
I0=32

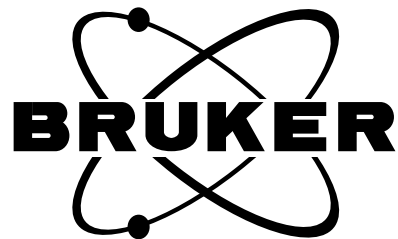
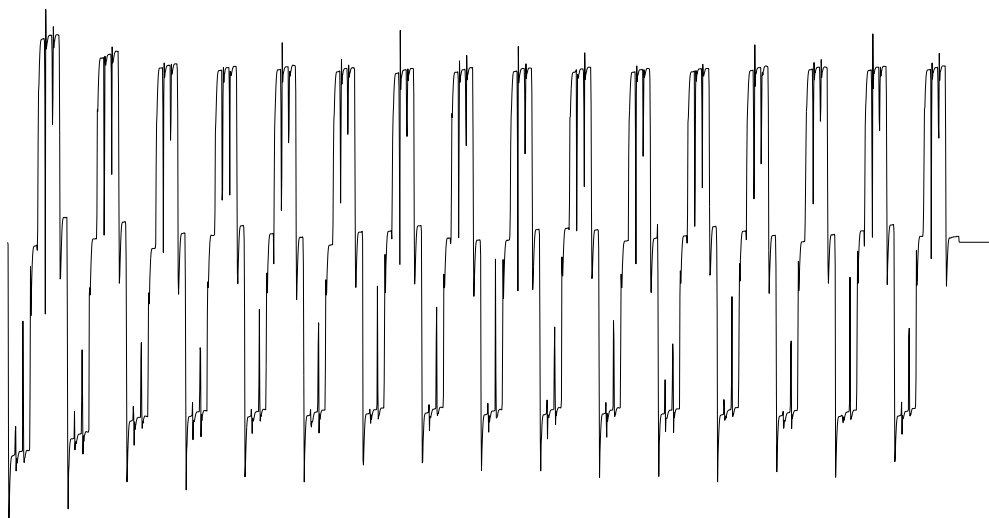

Figure 5.7. Tune pattern for +y, -y phase



Tune pattern for +y or -y phase
10=32

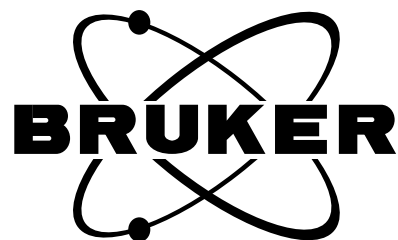
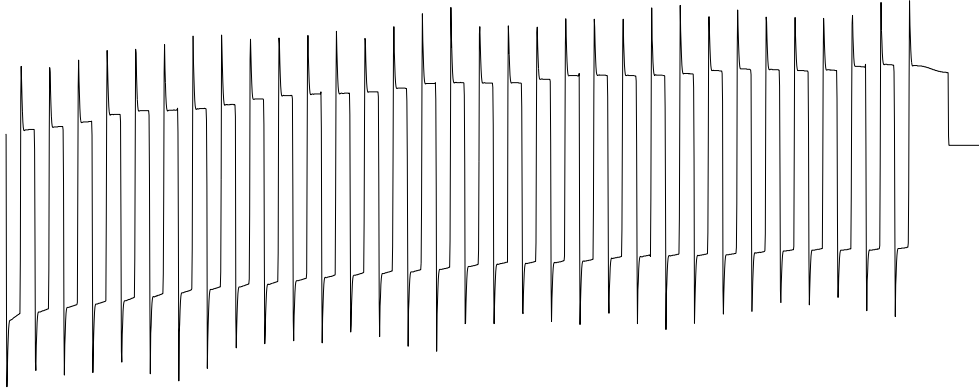

Figure 5.8. Tune pattern for +x - x sequence (glitch test)



Glitch test pattern for the +x -x
sequence:
pattern should show no more
curvature than in this example;
a visible sinewave indicates a problem

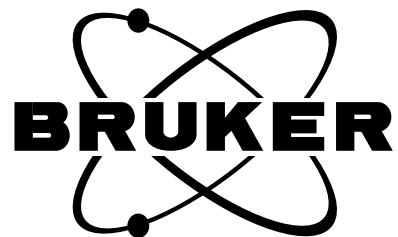
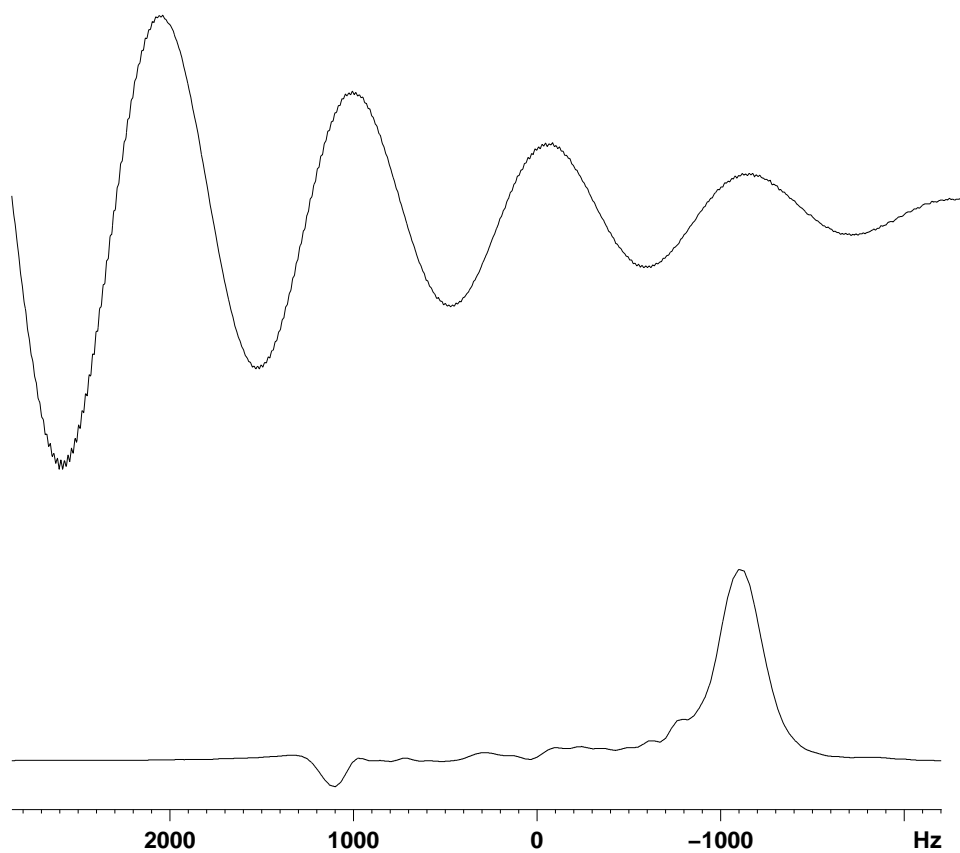

Figure 5.9. MREV- 8 or BR- 24 on water, residual glitch measurement



br24 on water:
the observe offset O1 is set exactly at water
resonance. With br-24, an offset from resonance
is observed. It should be less than 1000 Hz
(prior calibration of SWH is required)

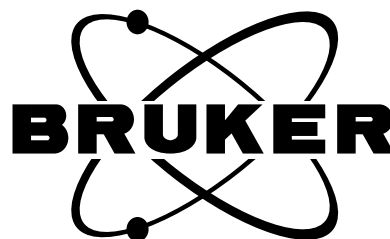
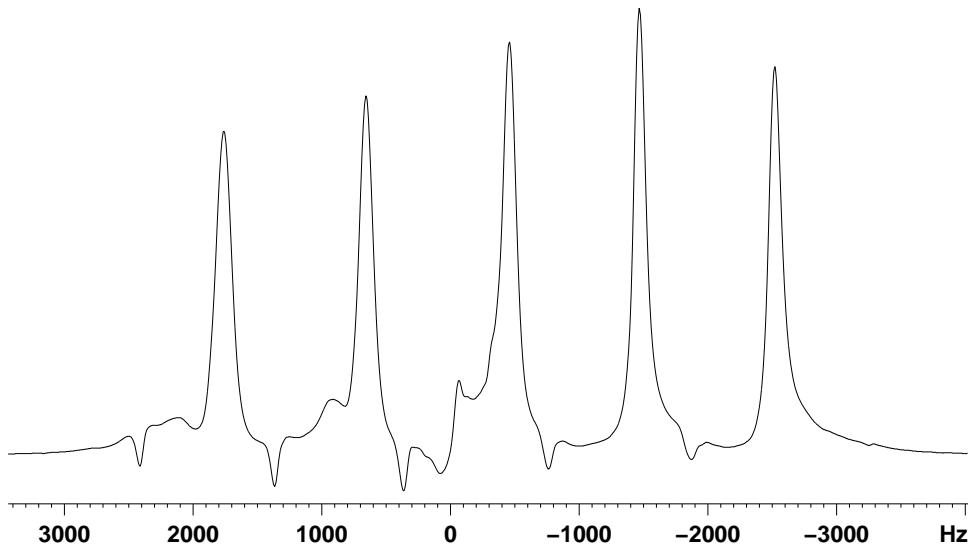

Figure 5.10. Offset optimization and calibration with MREV- 8 or BR- 24



**Offset variation with br-24 on water:
this serves to find the best offset
(visible by the peak intensity)
and a calibration of the actual sweep width.
Offsets range from 2000 to -2000
in 1000 Hz steps. Best offset is found
at +2000 Hz**

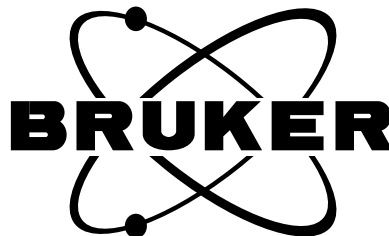
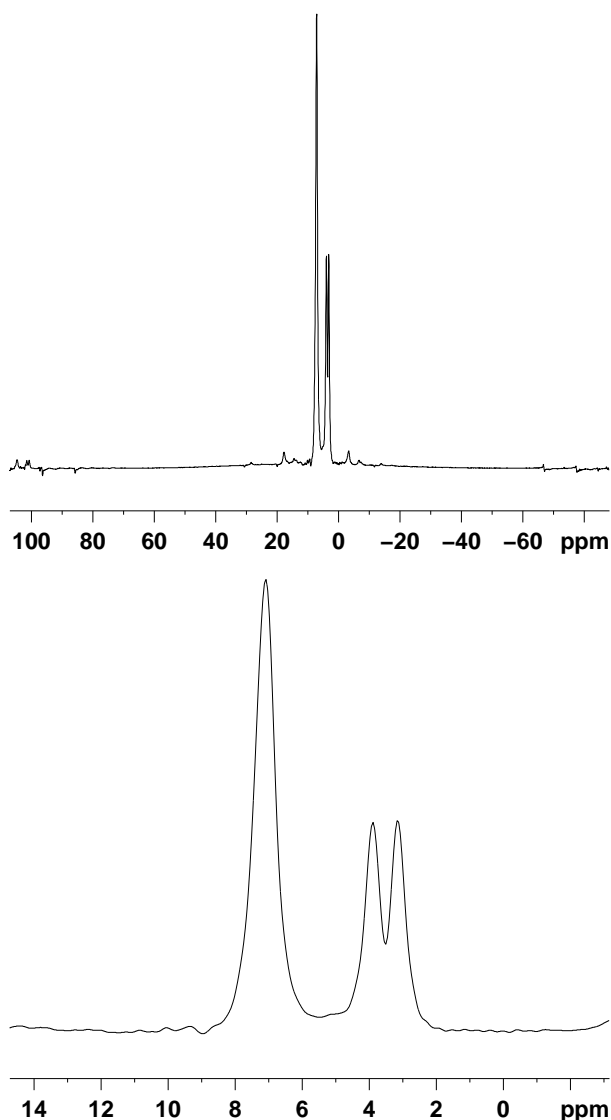

Figure 5.11. MREV-8 on glycine powder, CRAMPS probe



Current Data Parameters

NAME glymrev
EXPNO 2
PROCNO 1

F2 - Acquisition Parameters

Date_ 960716
Time 16.24
INSTRUM spect
PROBHD MAS 4 mm
PULPROG mrev8.rel
TD 1024
SOLVENT CDCl3
NS 4
DS 0
SWH 125000.000 Hz
FIDRES 122.070312 Hz
AQ 0.0041460 sec
RG 32
DW 4.000 usec
DE 5.71 usec
TE 300.0 K
P1 1.80 usec
D3 0.0000310 sec
small 0.0000013 sec
P0 0.40 usec
acq 0.0000040 sec
large 0.0000044 sec
phalf 0.9 usec
TD 1024
I0 255
D1 4.00000000 sec
PL1 3.95 dB
SFO1 400.132000 MHz
NUC1 1H

F2 - Processing parameters

SI 4096
SF 400.1286882 MHz
WDW no
SSB 0
LB 0.00 Hz
GB 0
PC 1.00

Glycine powder, MREV-8 1H CRAMPS spectrum,
quad detected.
top: full plot, note large SW due to shorter
cycle time compared to br-24
bottom: expansion
note lower baseline resolution and
peak resolution compared to BR-24

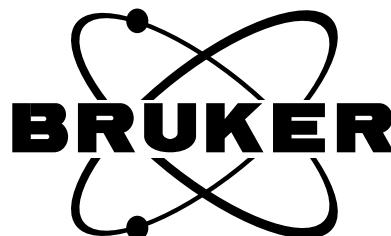

CRAMPS Experiments on DMX/DSX Instruments

Figure 5.12. BR- 24 on glycine powder, CRAMPS probe

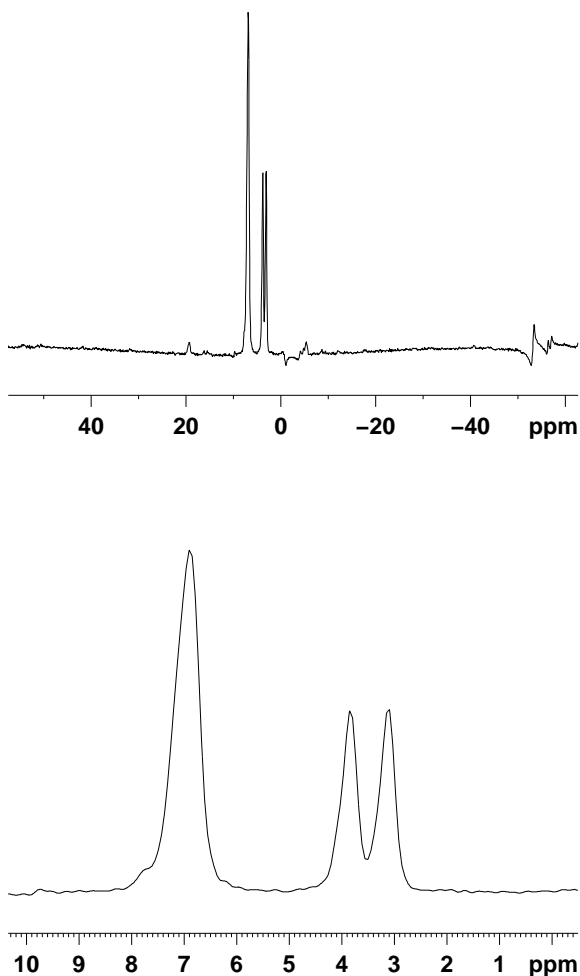

```

Current Data Parameters
NAME      glybr24
EXPNO     4
PROCNO    1

F2 - Acquisition Parameters
Date_     960212
Time      15.03
INSTRUM   spect
PROBHD    MAS 4 mm
PULPROG   br24.rel
TD         1024
SOLVENT   CDCl3
NS         4
DS         0
SWH       36036.035 Hz
FIDRES    35.191441 Hz
AQ        0.0142580 sec
RG         32
DW        13.875 usec
DE        19.82 usec
TE        300.0 K
P1        1.80 usec
D3        0.00000280 sec
small     0.0000010 sec
P0        0.30 usec
acq       0.0000035 sec
large     0.0000038 sec
TD        1024
count     256
PL1       -3.00 dB
D1        5.00000000 sec
SFO1     299.8700000 MHz
NUC1      1H
P4        1.10 usec

F2 - Processing parameters
SI        2048
SF        299.8707804 MHz
WDW       no
SSB       0
LB        0.00 Hz
GB        0
PC        1.00
    
```

Glycine, 1H CRAMPS, BR-24 quad detected CRAMPS probe. Advantage over CP probe is shorter window (usually <3.2 usec vs. 3.2-4 usec in CP probe, depending on probe type and frequency) and higher sensitivity. Note better peak separation. Peak resolution requires shimming on adamantane in a CRAMPS spinner with BR-24 decoupling.

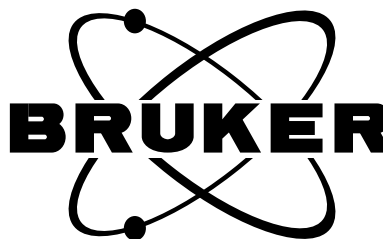
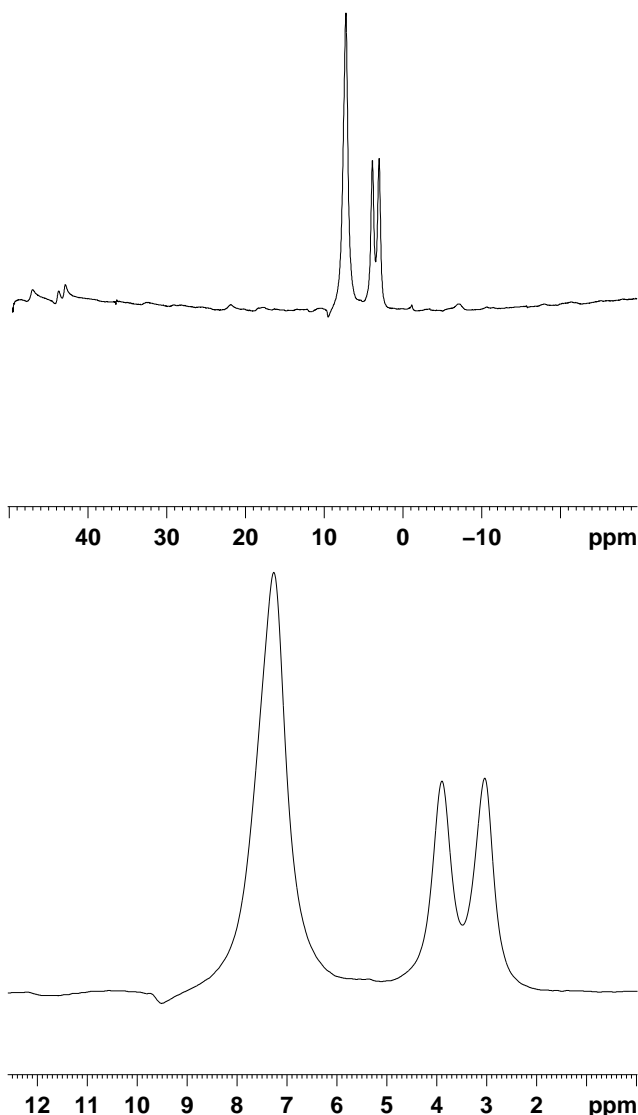

Figure 5.13. BR-24 on glycine powder, CP probe



```

Current Data Parameters
NAME      glybr24
EXPNO     3
PROCNO    1

F2 - Acquisition Parameters
Date_     960716
Time      16.32
INSTRUM   spect
PROBHD    MAS 4 mm
PULPROG   br24.rel
TD         1024
SOLVENT   CDCl3
NS         4
DS         0
SWH        32000.000 Hz
FIDRES     31.250000 Hz
AQ         0.0160500 sec
RG         32
DW         15.625 usec
DE         22.32 usec
TE         300.0 K
P1         1.80 usec
D3         0.00000350 sec
small     0.0000017 sec
P0         0.40 usec
acq       0.0000048 sec
large     0.0000052 sec
TD         1024
count     256
PL1       3.70 dB
D1         4.00000000 sec
SFO1      400.1320000 MHz
NUC1      1H
P4         0.95 usec

F2 - Processing parameters
SI         4096
SF         400.1281542 MHz
WDW        no
SSB        0
LB         0.00 Hz
GB         0
PC         1.00

```

Glycine 1H CRAMPS, BR-24 quad detected,
CP probe proton channel. Longer cycle
time and optimization of probe for
X-observation mean lower resolution
and less signal to noise.

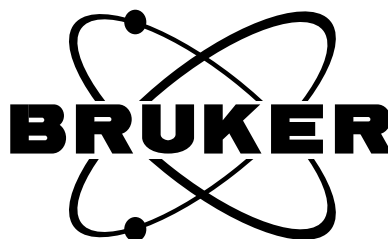

CRAMPS Experiments on DMX/DSX Instruments

Figure 5.14. BR- 24 on glycine, phcor4 misadjusted

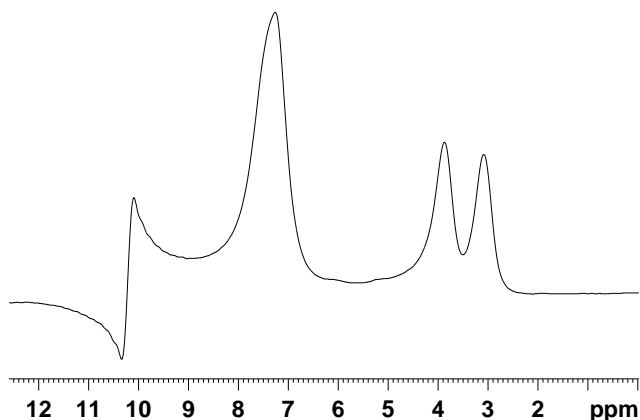
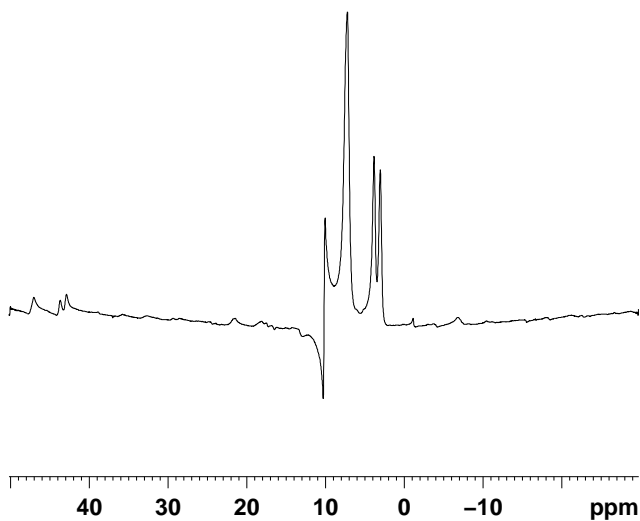

```

Current Data Parameters
NAME      glybr24
EXPNO     7
PROCNO    1

F2 - Acquisition Parameters
Date_     960716
Time      17.05
INSTRUM   spect
PROBHD    MAS 4 mm
PULPROG   br24.rel
TD         1024
SOLVENT   CDCl3
NS         4
DS         0
SWH        32000.000 Hz
FIDRES     31.250000 Hz
AQ         0.0160500 sec
RG         32
DW         15.625 usec
DE         22.32 usec
TE         300.0 K
P1         1.80 usec
D3         0.00000350 sec
small     0.0000017 sec
P0        0.40 usec
acq       0.0000048 sec
large     0.0000052 sec
TD         1024
count     256
PL1       3.70 dB
D1         4.00000000 sec
SFO1      400.1320000 MHz
NUC1      1H
P4         0.95 usec

F2 - Processing parameters
SI         4096
SF         400.1279121 MHz
WDW        no
SSB        0
LB         0.00 Hz
GB         0
PC         1.00
    
```

Glycine CRAMPS, BR-24 quad detected phcor4 misadjusted. The pulse program has a 230 degree preset for phase 4, so only a few degrees adjustment are necessary for phcor4.

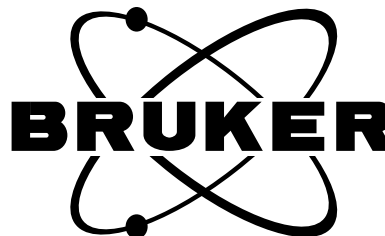
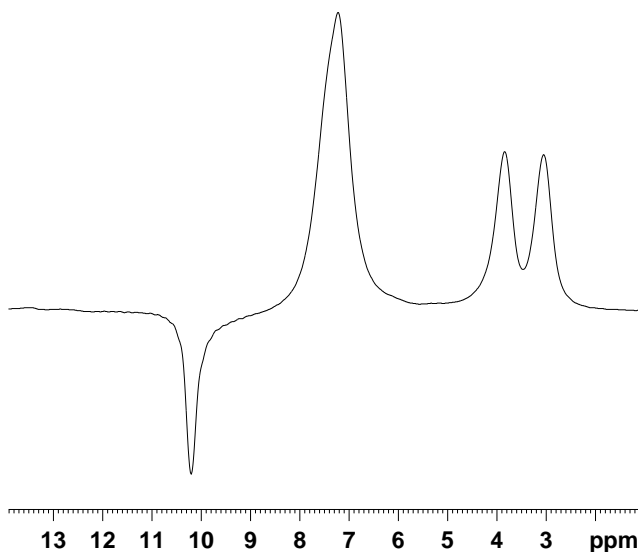
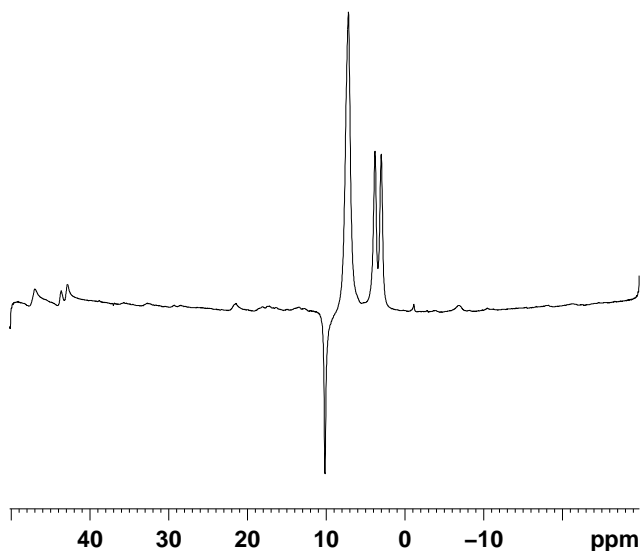

Figure 5.15. BR-24 on glycine, p4 misadjusted



Current Data Parameters

NAME glybr24
EXPNO 6
PROCNO 1

F2 - Acquisition Parameters

Date_ 960716
Time 17.03
INSTRUM spect
PROBHD MAS 4 mm
PULPROG br24.rel
TD 1024
SOLVENT CDCI3
NS 4
DS 0
SWH 32000.000 Hz
FIDRES 31.250000 Hz
AQ 0.0160500 sec
RG 32
DW 15.625 usec
DE 22.32 usec
TE 300.0 K
P1 1.80 usec
D3 0.00000350 sec
small 0.0000017 sec
P0 0.40 usec
acq 0.0000048 sec
large 0.0000052 sec
TD 1024
count 256
PL1 3.70 dB
D1 4.00000000 sec
SFO1 400.1320000 MHz
NUC1 1H
P4 1.30 usec

F2 - Processing parameters

SI 4096
SF 400.1279121 MHz
WDW no
SSB 0
LB 0.00 Hz
GB 0
PC 1.00

BR-24 quad detected, p4 magic pulse
misadjusted, note size and phase
of center spike compared to phcor4
misadjustment and correct spectrum

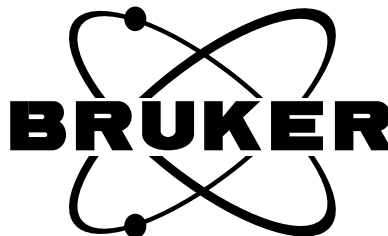

CRAMPS Experiments on DMX/DSX Instruments

Figure 5.16. BR- 24, digitally filtered, on glycine powder

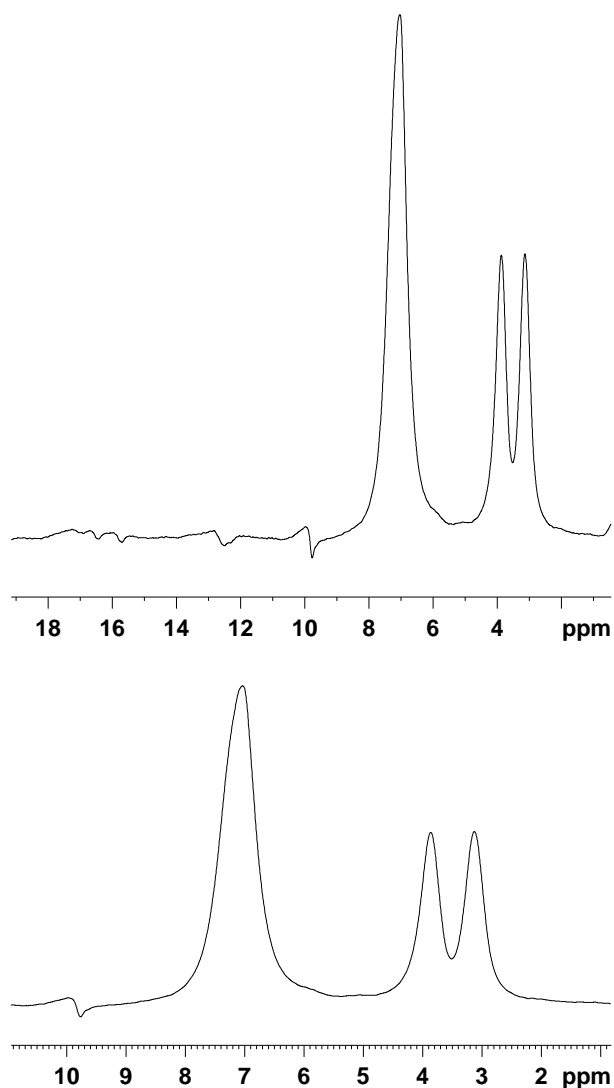

```

Current Data Parameters
NAME      glybr24
EXPNO     8
PROCNO    1

F2 - Acquisition Parameters
Date_     960716
Time      17.08
INSTRUM   spect
PROBHD    MAS 4 mm
PULPROG   br24.rel
TD         512
SOLVENT   CDCl3
NS         4
DS         0
SWH       7485.030 Hz
FIDRES    14.619199 Hz
AQ         0.0342516 sec
RG         32
DW         66.800 usec
DE         22.32 usec
TE         300.0 K
P1         1.80 usec
D3         0.00000350 sec
small     0.0000017 sec
P0         0.40 usec
acq       0.0000048 sec
large     0.0000052 sec
TD         512
count     2048
PL1       3.70 dB
D1         4.00000000 sec
SFO1      400.1320000 MHz
NUC1      1H
P4         0.95 usec

F2 - Processing parameters
SI         4096
SF         400.1280796 MHz
WDW        no
SSB        0
LB         0.00 Hz
GB         0
PC         1.00
    
```

Glycine powder, 1H CRAMPS, br-24 with 4fold
oversampling and digital filter
top: full plot
bottom: expansion
Due to the 4-fold oversampling, td should be decreased by
at least a factor of 2 to avoid probe overheating
due to very long cycles.
Correct spectrum calibration must be set by
adjusting 2s sw and subsequent ft.

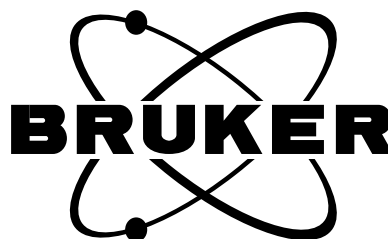

Usually, one starts to look for problems if

- There is no signal or the signal is too weak
- The signal to noise is much lower than usually
- The signal is distorted.
- The spectrum contains unwanted signals
- The experimental result is not the expected one.

In the latter case, the instrument performance should be checked with the simplest derivative of the executed sequence, say with a simple one pulse acquisition with or without decoupling, or a simple basic CP experiment. If performance is correct there, the problem is almost always either incorrect experiment setup, or errors in pulse programming, or use of inadequate samples or hardware.

If a complex experiment does not work to perfection, check the basic experiment first before dismantling the hardware. If an unknown sample does not give a perfect result, check known samples first. If signal to noise looks bad, rerun the specified signal to noise test.

In any case, assume first a trivial problem before you take the spectrometer apart. Never assume that all trivialities are properly done, always make sure that they are done.

1. Check whether the sample is properly inserted.
2. Check whether it spins.
3. Check the probe tuning on all channels.
4. Check all probe connections, check preamp selection, check HPHPPR matching box frequency range.
5. Check the data set: power levels, spectrometer frequencies, pulse program.
6. Do „ased“ and check all parameters used.
7. View the pulse program with edcpul and look for HP transmitter gain settings used.
8. Check tune and gain settings on HPCU keypad.
9. Check HP transmitter configuration in edasp and type rackpow to switch router relays, check the voltage supervision LEDs at the high voltage power supply, check whether the HV voltage LED is on at the HPCU keypad (green) and at the high voltage power supply, below the high voltage cables (red). Check tube transmitter matching box frequency range. Check transmitter cables to preamp or probe.

10. Check pulse outputs on BSMS keypad, HPCU keypad (use fine button if necessary), open cabinet door and check whether the driver transmitter show pulse output on LED display, check if mismatch LED comes on.
11. Check filters inserted in probe RF connections.
12. Check shims and field setting on BSMS keypad.
13. Check whether the magnet is still on field.

This is how far a non privileged user may proceed

⇒ **Warning: Inexperienced operators should not try to execute any tests described in the following chapter but call the system administrator.**

Test procedures described in this chapter require profound knowledge of the system as a whole!

⇒ **Only do what you have been trained to do and understand all consequences!**

Establishing ethernet communication to the CCU

6.2

The local ethernet is established upon system installation or with the „installnet“ shellsript. Please do not fudge with the IRIX network manager or with any file related to networking.

Upon configuration, do not change the instrument name unless you are aware of the consequences.

Assuming that the network is properly configured, communication to the CCU may have to be re-established if in UXNMR, a communication problem is reported. This will produce the error message „remote connect: connection refused“, usually after ll, gs or zg. If this problem persists, try a remote login to the spectrometer. In a UNIX window, type rlogin or telnet <spectrometer name>. If the spectrometer prompt does not appear, there is a communication problem. In such a case, turn off the acquisition rack, and start reviveccu in /u/prog/<uxnmr.version>. This will remove some files and reboot the host computer. After that, the AQX rack can be switched on again to reestablish communication.

⇒ **If for hardware service, the aqx rack must be switched off, first shut down the CCU by loggin in on the spectrometer and typing init 5.**

If this is not done before the rack is switched off, it may be necessary to do reviveccu before the communication can be established.

Test software for TCU, FCU and RCU

6.3

The test software for TCU, FCU and RCU must be started on the spectrometer. Log in on the spectrometer and go to /u/systest. There are sub-directories TCU, FCU and RCU. Go to the appropriate sub-directory and start the test software with /fcutest, tcutest or rcutest. In all test programs, there is an „auto“ test that will run though all test procedures.

Test software for RS232 and RS485 controlled units**6.4**

Peripheral units controlled via RS 232 are tested or reconfigured using different test programs. They can be called in a UNIX window by typing their names.

rstest contains submenus for the following units:

- BSMS shim power supply
- BACS high resolution sample changer
- VTU, variable temperature unit
- HPCU high power control unit
- MAS, MAS pneumatic unit
- ACB, transmitter control board

With „?“ a command list can be generated.

Additional stand-alone test programs are:

- BSMS for the shim control unit
- ACB for the transmitter control board
- RXC or RX22 for the receiver control board
- HPPR for the preamplifier unit.

In most cases, these tests are only used to test the communication to the units. This is of course only possible if all units have been properly configured in „cf“ spectrometer configuration or with separate configuration routines as outlined in I.8. Please remember, that units connected to the HPCU can only be addressed or tested if they are recognized by the HPCU. This is only possible if these units were on when the HPCU was turned on.

If the MAS pneumatic unit and the 4-phase modulator are controlled by the HPCU, the AQR rack must be on and the MAS unit must be on and in the „remote mode“ to be recognized when the HPCU is turned on.

To debug software communication problems between peripheral RS 232 or 485 devices and CCU, there is a debug module available. Within X-WinNMR (vers. 1.2 or later) call the module by debugmod (xwish debugmod in older versions) and establish a directory for a debug file which can be transferred to our software department for help. The peripheral unit under test is selected by choosing a debug file name for it.

RF hardware troubleshooting.**6.5**

This section assumes that the spectrometer has been functioning and was properly set up and configured. Refer to previous sections if an acquisition does not start up properly. Most problems can be localized without additional tools (oscilloscope, high power attenuator, directional coupler). However, searching is much easier if at least a high power attenuator and a scope are present because then RF pulses can be quantified in terms of voltage and frequency. Make sure that this equipment is properly used and the measurements are properly validated.

For all test experiments, make sure that:

- No RF pp voltage higher than 0.5 V is fed into the receiver

- No RF pp Voltage higher than 20 V is fed into an oscilloscope
- Always use appropriate attenuation!
- No high power pulses are fed into a HP probe that exceed the normal range used in experiments
- Never set transmitter gains or drive power levels higher than used during an experiment!
- No drive RF pulse power exceeding the normal level is fed into a transmitter input

It is very helpful for later problem searches, if the following routines are executed once when the spectrometer works properly and all measured values are noted for comparison with the corresponding measurements in the case of failure.

The signal is too weak or there is no signal

6.5.1

In any case, assume first a trivial problem before you take the spectrometer apart. Never assume that all trivialities are properly done, always make sure that they are done.

1. Check whether the sample is properly inserted
2. Check whether it spins
3. Check the probe tuning on all channels
4. Check all probe connections, check preamp selection, check HPHPPR matching box frequency range
5. Check the data set: power levels, spectrometer frequencies, pulse program
6. Do „ased“ and check all used parameters
7. View the pulse program with edcpul and look for HP transmitter gain settings used
8. Check tune and gain settings on HPCU keypad
9. Check HP transmitter configuration in edasp and type rackpow to switch router relais, check the voltage supervision LED's at the high voltage power supply, check whether the HV voltage LED is on at the HPCU keypad (green) and at the high voltage power supply, below the high voltage cables (red). Check tube transmitter matching box frequency range. Check transmitter cables to preamp or probe.
10. Check pulse outputs on BSMS keypad, HPCU keypad (use fine button if necessary), open cabinet door and check whether the driver transmitter show pulse output on LED display, check if mismatch LED comes on.
11. Check filters inserted in probe RF connections
12. Check shims and field setting on BSMS keypad.
13. Check whether the magnet is still on field

Refer to the section on WOBB if WOBB does not function as expected.

Refer to the section of probe troubleshooting if probe does not tune.

Refer to the section of transmitter troubleshooting if pulse power is incorrect.

Refer to the section of receiver troubleshooting if there is no or very little signal and very small noise.

If no obvious problem is detected, set the experiment up again on the setup sample for this experiment.

If the setup sample does not give the desired result, try to re-optimize.

Problem persists

It makes no sense to look further for problems if the sample is not known. First insert a setup sample for which a reference data set exists and a strong signal on few scans with decent recycle delay is to be expected, using a simple one pulse program, preferably a liquid sample. For double resonance experiments, the liquid sample should contain both nuclei to be observed in ample concentration to simplify the test. If a nucleus to be observed has very low NMR sensitivity, switch to another nucleus with higher sensitivity which is close in frequency so transmitters need not be grossly detuned.

1. Tune all probe channels with WOBB.
2. Run simple one pulse accumulation on both nuclei, check the signal to noise.
3. If signals look normal, re-check pulse lengths and power levels.
4. If pulses look abnormally long, go to transmitter section.
5. If signal looks too noisy, go to receiver section.
6. If signals and power levels look ok, check shims and field setting, then go back to the desired experiment and run it on a sample where it has worked before. Set the experiment up again on that sample.
7. If no signal is detected, open up the spectral window and search for the signal.
8. If the signal is found at a very different position, check the field on a water sample, looking at the proton signal in a probe with proton channel. With SFO1 set to the nominal spectrometer frequency, the proton signal should be between +/- 10 kHz.
9. If the signal is detected further away, make sure it is not folded and note the resonance frequency.
10. Check the homogeneity, try to shim if necessary. If shimming is not possible or signal not where it should be even after BSMS field adjustment, check helium level and nitrogen level, check last filling dates, check magnet log book, ask around whether accidents have happened, check magnet dewar for icing on towers or for dents, then call magnet service and report.
11. No signal can be found anywhere, check the noise at $RG \geq 4k$. If noise looks abnormally small, refer to the receiver section.

The transmitter section

In case that no pulses have been detected at all on any of the frequency channels, check the frequency generation first. If pulses are there, but too weak, work your way back from the preamp to probe cable as described under 2)

1. Frequency generation

An oscilloscope is required, a frequency counter is nice but usually not required, since in general, the frequencies, if wrong, are totally wrong so the scope will show the problem. Find the PTS 620 synthesizer or any other synthesizer which generates the frequency where the problem occurs.

- Check the 10 MHz output, >1Vpp of 10 MHz must be present.
- Set the frequency channel where the problem exists to the desired frequency in edasp, type II.
- Check the F1, F2, or F3 output BNC. If the frequency channel is configured via a SE-451 T-FH or T-FX board, the frequency must be [440 MHz-SFO1,2,3]. If the configuration is unclear, go to a unix shell window, change directory to /u/conf/instr/<spectrometer name> and type jot uxnmr.info. F1 and F2 always go via the SE-451 so the above formula is correct. F3 may be via a T-FX board or direct. If direct, the synthesizer output must be = SFO3 or SFO4. The output levels must be > 1Vpp. Usually, the frequencies there are either correct or totally wrong, mostly however, the level is too small if there is any problem.
- If the frequency is totally wrong or the level too low, check the input frequency into the synthesizer from the FCU. The frequency must be between 3 and 4 MHz with a level of > 1Vpp. Do not worry if this frequency looks „dirty“. If the frequency is off or too low in voltage, execute an FCU test. If problems are detected, report to the BRUKER service station.
- If The synthesizer output looks ok, check whether the same level of RF is detected at the SE-451 frequency input or at the ASU input for „direct“ frequency channels. This checks whether there is a cable problem.
- If O.k. there, go to 2)

2. Transmitter checkup



Warning: THE FOLLOWING OPERATIONS MAY LEAD TO HARDWARE DAMAGE IF EXECUTED IMPROPERLY

a) Tube transmitter

- Connect the cable from preamp to probe of the non-functional channel to a 50 Ohm attenuator that can handle pulse powers of up to 1 kW, replacing the probe. Connect the output from the attenuator to the scope. Connect the scope trigger input to the power router trigger output labelled NMR5-13, set the scope to external trigger source. If a dummy load attenuator is not available (min. 30 dB total), use the probe as load with a suitable directional coupler inserted before the probe, connect scope to the forward power connector and make sure the transmitter output is set to a legal level. If a directional coupler is also not available, set the transmitter power level to a legal value and pulse into a double resonance probe channel tuned to that frequency, connect the scope to the other probe channel. The cross talk between probe channels will allow to monitor the pulses with about 20-30 dB attenuation (CP/MAS probe or triple resonance CP/MAS probe). Make sure that the pulse power cannot exceed a level which is routinely used.
- Set up for pulsing on this channel. For F1, set the nucleus on channel 1 in edasp, route into the appropriate high power amplifier and preamp, type rackpow to activate the routing. Set drive power level as normally used. Load pulse program txttest with p1=100 usec, d3=20 usec, d1=100msec. For F2, change the routing in edasp to use the F2 channel (proton channel). For F3 generated via the 3rd SE-451 channel, set up as for F1 and click switch F1/F3 in edasp to change to the F3 channel. Connect F3 transmitter output to the attenuator, directional coupler or probe channel. For F3 channels with direct frequency generation, the pulse program must be rewritten for F3 pulses and edasp be set up for the F3 channel. Pulse and observe pulses on the scope. For tunable amplifiers, check transmitter tuning, try to optimize pulse shape and pulse pp-voltage by tun-

ing the amplifier. Estimate transmitter pulse power. N.B. when pulsing into a probe, the pulse shape may not look perfect. If the pulse power looks far too low or if there is no pulse, check the drive transmitter output at the drive transmitter N type output socket. If the output looks o.k there, check at the high power transmitter input cable. If no input pulse there, check the high power router relay. If the drive transmitter pulses are insufficient, check the drive transmitter

b) Drive transmitter or linear solid state high power amplifier (AMT)

- Check whether an RF pulse goes in that roughly corresponds to a 1 Vpp pulse attenuated by the pl1 or pl3 value used (pl values in dB), for pl1 of 10, the pulse pp voltage should be around 200-300 mVpp

- Check whether the unblanking DC pulse goes in (-4.5 V)

- Check the supervision LED's while pulsing

- Note that the B-LAH 1H/19F linear amplifier has 3 RF and gate inputs. The high inputs are used for all high power experiments. If the drive transmitter receives a sufficient input RF pulse and an unblanking DC pulse starting 1-3 usec before the RF pulse (check edskon parameter blanktr for this value), and the pulse output seems inadequate, call the service station for further advice. If either input is inadequate or missing, proceed with 3).

3. If a linear drive amplifier or high power amplifier receives no input RF or gate pulse, check at the low power router (AVANCE router, in the acquisition rack AQR) output for this frequency channel. There are 8 SMD connectors. From the top, the connectors are 1H in, X in, Y in, Y out, X out and 1H high out. Check the output at SMD4 for F3, at SMD 5 for F1 (X-range), at SMD 6 for F1 (1H) or F2 (1H). Depending on the drive power level pl(n), there should be more than 1 Vpp for a value of -6. From there, follow the chain back to the SE-451 checking the input to the router at SMD 1-3, the ASU output, and the ASU input for the appropriate channel. If there is not input RF pulse into a high power linear amplifier (AMT), but the router output is there, check the low power switch in the high power router. If any gate pulses are missing, check at the corresponding FCU. There is a SMB miniclick connector between FCU1 and FCU2 labelled TGPF1 (for F1) and TGPF2 (for F2).

The gate pulse for F3 is labelled TGPF1 at the connector between FCU2 and FCU3, for F4 it is labelled TGPF2 on the same connector board.

The receiver section

If the RF pulses are found to be o.k. or not exceedingly off, if the frequency generation produces the correct frequencies at correct voltages, the problem must be on the signal detection side. Usually, if there is a hardware problem in the signal detection, WOBB will not work with the error message „signal too weak“. Refer to the WOBB chapter for problems with WOBB.

Usually, if the receiver section does not perform properly, the signal is down and the noise is also down. If the signal is ok, but the noise appears unusually big, the receiver section works but there is additional noise picked up; refer to the next para in that case. If the receiver has a problem, the problem will exist independently of the observe channel or preamplifier. If the receiver reference is not selected properly according to the path selection in edasp, the problem will not show equally on any observe channel. If a preamplifier has a problem, observation on a different preamplifier will work correctly. So if the signal and the noise are too small on one channel, try observation on any other available channel first.

A quick check on the receiving pathway uses the noise as a signal:

Load a single pulse acquisition data set for that desired nucleus. Set the pulse drive power level (usually pl1) to 120 (dB), so there is no pulse executed and therefore there is no signal. Set SWH to 125 kHz, digmod to analogue, aq to 50 msec, d1 to 100 ms, fw =6e6,digtyp SADC or HADC. Start with gs. Set rg=16k. The noise band should cover 2 units of the grid vertically. Expand the vertical display until the noise fills half the screen. If the noise is clipped by the digitizer, the signal amplification is o.k. If not, set rg= 8k and watch whether the noise changes accordingly. Set hpprgn to plus (or to normal if it was plus), halt gs and start gs again, watch the change in noise at the same vertical expansion. The noise amplitude should change by a factor of 2 by a rg change of a factor of 2. If there is little change, the receiver or the receiver gain setting does not work. The hpprgn high/low change should change the noise by more than a factor of 2. If the noise band with rg=16k is substantially less than 1 grid unit, the preamplifier and/or receiver are blanked during the observation. In that case, the individual digitizer bits can be recognized as sharply defined bands above and below the noise center after vertical expansion to fill the screen. Check the pulse sequence for a:e blanking entry after the adc acquisition trigger. If there is no:e, the blanking circuit is not working properly. Call for advice. If the noise level at rg 16k is clipped by the digitizer, reduce rg until the noise is not clipped and fills half the display. Disconnect the cable from the observe preamp to the probe or connect it if it was disconnected. With the probe connected, the noise should be bigger. If this makes no change at all, the preamplifier is not properly selected. Check the preamp cover display what preamp is selected. If the selection is correctly indicated, find the SMD connector of the selected preamplifier that carries the signal up to the signal router underneath the preamp housing cover. It is at the preamplifier left side underneath a grey plastic cover. Connect the signal output directly to the orange labelled thick RF cable at the cover module back (SMD to BNC adapter required) that carries the signal to the SE-451 receiver. Check the noise amplitude without and with probe (or dummy load) connected. If the behaviour is now normal, the cabling or the router box in the preamp assembly has a problem.

The test procedure can be executed in a more quantitative way preferable over the noise test which may be hard to value with little experience. However, internal re-cabling is required and care must be taken.

⇒ ***Do this test only if you understand what it is doing***

Modify the tx4c pulse program such that the adc command is given prior to the RF pulse on F1, moving the line 1u adc ph31 behind the line trigg. Set pl1 =pl2 =pl3 =pl4 to 120. Pulsing rapidly on the frequency channel under test will generate 4 very low power RF pulses which can be taken as signal. This signal is available at the AVANCE router in the AQR rack SMD connectors 4 (F3), 5(F1) or 6 (F2) or at the appropriate drive transmitter RF input (cable with BNC or SMD connector).

⇒ ***Never use a transmitter pulse output for this test***

Note that the same pulse program can be used to test F1 or F2 (also F3 with a 3 channel SE-451) signal observation, depending on the edasp setup. Use SADC or HADC, swh=125e3, rg=1-1k., p1=100 usec, d3= 50 usec, aq=2msec, d1=100 msec, pl1-4=40. Feed the low voltage pulse signal into the SE-451 RF in signal input and search for the 4 pulses as squares using the unshuffled display. If a 4-phase modulator is present, the square signals will have different phases, if no 4-phase modulator is present, the squares will have the same phase in audio channel a, a different phase in audio channel b. Now change the receiver gain and check whether the amplitude changes correspond to the change in rg. It should be possible to cause adc clipping increasing the receiver gain at pl1-4 =80. Do this test on all SE-451 channels.

Reset pl1-4 to 120, and repeat the test with the signal cable from the preamplifier cover module (thick orange labelled cable) reconnected to the SE-451 RF in BNC connector and feeding the very weak RF pulses into the selected preamplifier to probe cable. Change the edasp setup from using an X frequency to proton frequency with the weak pulses taken from the appropriate AQR router output. If the signal is not observable, check at the preamplifier RF output either with a scope or with the RF in signal input of the SE-451 connected there.

Call the service if a problem is found. The preamplifier should amplify the voltage of the pulse signals about 20fold with hprgn set to normal, and about 100fold with hprgn set to plus.

The signal to noise is much lower than usually, but the spectrum looks otherwise correct

6.5.2

In such a case, always verify that there is indeed a loss in signal to noise by running a known sample, preferably the signal to noise test sample after a careful experiment setup. Never assume a loss in signal to noise if a new and complicated experiment is tried or a an unknown sample is run.

The signal to noise is usually determined by the probe performance, and the preamplifier performance.

However, there is many ways to reduce the signal to noise.

If there is a preamplifier problem, it will show in much smaller signal amplitudes than normal since it will amplify less.

If the problem is in the probe, it means usually that the probe tuning is not correct, or the probe arcs.

Other phenomena that may cause signal to noise loss are:

- Heteronuclear decoupling during the acquisition generates additional noise
- Stray frequencies are picked up
- Bad cables are used to connect probe and preamplifier, or connections have bad contact
- The sample is not inside the coil
- Scan accumulation does not work properly
- The audio filter setting is not correct
- Pulse powers and pulse lengths are not properly set
- Pulse shapes are distorted (see chapter on pulse imperfections)
- Phase shifts are not correct

Locating the reason for loss in signal to noise

As mentioned before, it makes no sense at all to judge signal to noise on any non standard experiment or sample. If you suspect a loss in signal to noise, verify this first by running a sensitivity test on a standard sample, using a standard pulse program.

If signal to noise proves to be bad, check:

- Is the relaxation delay long enough, check whether the FID initial amplitude doubles with the second scan
- Are the shims and the BSMS field setting correct?
- Are drive power levels, pulse widths, delays set correctly?
- Are all HPCU settings correct (tune and gain values)
- Is the audio filter correct (watch: if digmod=analog, there is no audio filter even for small swh with HADC or SADC)
- Are the 90 degree pulse widths still correct (tubes age!)
- Is the probe tuned correctly on all channels?
- Is the sample in the coil center (nonspinning probes)
- Is the sample what you expect it to be?
- Is the spinner full of sample?
- Is the magic angle properly set?
- Are all necessary filters inserted?
- Are you comparing results with different processing procedures (different LB)?
- Is the field sweep active without using the field-frequency lock?
- Is cross polarization used with spinning speed high compared to the X-H dipolar coupling? („high“ means > 4 kHz for samples like adamantane, > 8kHz for samples like glycine)

If you are convinced that there is a problem since on the same sample, the same experiment, the signal to noise was noticeably better before:

a) Reduce the complication of the experiment and check again:

From 2D experiments, go back to the basic 1D experiment and check sensitivity. If sensitivity is adequate, check: setup of 2D parameters, are excessively long pulses generated during the 2D evolution, does the probe warm up or arc in that case?

b) Sensitivity is still not adequate: reduce the number of frequency channels involved:

From a triple resonance experiment, go back to the basic double resonance experiment and check sensitivity. If sensitivity is o.k. now, check pulses on frequency channel 3, check power levels, check if all necessary filters are used (usually X-pass, Y-reject and Y-pass, X-reject filters are necessary). Check if the F3 transmitter goes on mismatch during the experiment, check for arcing on the F3 channel (use a directional coupler, monitoring reflected power with a scope, or just check with reduced power)

c) Sensitivity is still not adequate

Run the double resonance experiment in gs mode, watching the noise level on the FID. Set the drive power level for the decoupler to 120 dB, remove decoupler transmitter cable from probe, watch if noise level decreases. If it does, the probe may be arcing or noise from the decoupler may leak into the observe channel. Reconnect the decoupler transmitter to the probe, set the power level back to the original setting + 5 dB, then increase decoupler power in 1 dB steps. If the noise remains unchanged, and grows suddenly with a 1dB drive power level increase, the probe is arcing in the decoupler

channel. If the problem is noise leaking into the observe channel, the noise level on the FID will grow steadily with increasing decoupler drive power. Refer to the probe troubleshooting section if the probe arcs. If the problem is noise crosstalk from the decoupler to observe channel, external filtering is required. Usually, a bandbase for the decoupler frequency and a low pass or bandpass for the observe frequency will do.

d) The noise level is not influenced by the presence of decoupling pulses during the observe period. Reestablish the original parameters and check for arcs in the observe channel. This usually shows up as statistical variations in the observed FID amplitude during gs. Alternatively, the reflected RF power on the observe channel may be monitored with a directional coupler and oscilloscope. Refer to the probe troubleshooting section if the probe arcs on the observe channel.

e) If the FID remains stable in amplitude within many gs transients, or arcing cannot be observed as reflected RF, several other possible problem sources are possible.

- Stray frequencies are picked up: in that case the „noise“ on the FID will show regular patterns when inspected with horizontal expansion, the „noise“ in the fourier transformed spectrum will show discrete lines with linewidths of the digital resolution. Refer to the „spike hunting“ section.

- Accumulation does not work properly. In that case, compare the signal to noise after 1, 2, 4, 8, and 16 scans and check whether the signal grows as expected. For big signals, watch the FID build up on consecutive scans and check whether the initial FID amplitude grows by the same amount for every scan. If this is not the case (except, of course, for an experiment where signal cancellation is desired; such a sequence should not be used for that test), check the pulse program pulse phase list(s) and the receiver list (ph31). Check whether the spectrum appears normal or reversed (upfield peaks appear downfield from carrier offset). Check the size of the quadimages. If the spectrum appears reversed, change the receiver routing by replacing phases 1 with 3 and phases 3 with 1. Check if accumulation works and notify service. If the quadimages are substantially larger than 1%, notify service. The size of the quadimages in percent accounts for the same percentage in signal loss, if receiver phase cycling is used to suppress quadimages. If neither problem is detected but accumulation does not result in an appropriate growth of the FID, the pulse phases may be incorrect. This is hardly imaginable when DDS phase shifts are used, but when the 4-phase modulator phase shifting is used, it is possible. In that case, simplify the phase cycle of the sequence to only 1 excitation pulse phase and signal routing phase (ph31). Check whether the signal now grows as expected.

Accumulate sufficient signal to noise (100:1), ft and phase correct. Read the required 0 order phase correction. Now rewrite the pulse sequence for a 90 degree phase shifted excitation pulse (+y instead of +x) (ph31 unchanged!), repeat and verify that the 0 order phase correction has changed by 90 degrees, repeat for -x and -y excitation pulses, check the change in 0 order phase correction (should be 180 and 270 degrees different to the reference experiment). If one of the experiments requires the same 0 order phase correction as any of the other experiments, check the ph1 and ph2 SMB cables from the FCU that was used. Perhaps one of the pules does not arrive at the 4-phase modulator board. If the cables are interchanged, the phase change does not correspond to the pulse phases. (y pulse gives 90 degree phase correction change). To visualize the problem, the test described under 6.4.1 receiver section with the drive transmitter RF input pulses fed into the receiver can be used.

- The observe preamplifier has a problem. In that case, the signal amplitude will usually be much smaller than usual. Compare signal to noise to the high resolution preamplifier, make sure that preamplifier is not killed by long pulses or high power levels.

The signal looks distorted

6.5.3

Distortions may result from illegal conditions during the acquisition or from illegal processing conditions. For the sake of completeness, also trivial ones will be mentioned.

Processing problems:

- The lines show truncation wiggles even though the FID has been sampled with ample digital resolution, set `tdeff=0` or `=td`
- The center spike is unacceptable, set `bcmod` to `quad` to execute baseline correction before `ft`
- Despite baseline correction, the center spike is still substantial (`digmod=digital`), set `bcmod=qfil` with `bzfw=0.1`. Make sure that FID has decoupled to noise level within `ag`.
- The spectrum looks like a modulated FID close to resonance, but can be phased with extremely large 1st order phase correction (`digmod=digital`): Set `pknl` to `true` to enable automatic calculation of 1st order phase correction
- The spectrum cannot be properly phased with normal phase correction values: Check whether linear backward prediction is enabled in `memod`

Acquisition problems:

- The baseline has irregular roll which is not deadtime: The FID was clipped by the `adc` due to too high receiver gain `rg`. Take care, with digital filtering this clipping is frequently not recognized due to the data reduction. If uncertain, take 1 scan with `digmod=analog`.
- The baseline has deadtime roll (usually with $(\sin(x))/x$ appearance) even though the deadtime should cancel every other scan (`cp`, `quadecho` acquisition and `digmod=digital`). With this acquisition mode, it is not easily possible to do left shifts to shift out the deadtime. If this is done, `pknl` should be set to `false` before `ft`. It is better to adjust the deadtime delay before signal sampling appropriately such that deadtime is not acquired at all since the data reduction cannot handle the somewhat variable deadtime signal properly, so cancellation is incomplete.
- There is baseline roll due to deadtime or ringing (`digmod=analog`) on acquisitions with wide spectral widths. If deadtime cancellation is not possible with anti-ringing sequences, and left shifting distorts the baseline as well, refer to the section III, Quadrupolar Nuclei, about linear backward prediction to remove deadtime problems.
- The line shape shows asymmetric distortions where Lorentzian/Gaussian lines are expected: Check whether the field sweep is on, check the shim file (MAS experiments), try to improve the shims. If MAS spectra in the line width range of less than 10 Hz are expected, shimming becomes increasingly difficult.
 - In fields higher than 300 MHz
 - In small spinners (4mm)

c) When observing inhomogeneous samples

d) When proton lines are observed in highly mobile liquid like samples. For better line shape, order a coil made from magnetic susceptibility compensated wire, use CRAMPS spinners to prepare the sample, and make sure the sample volume is full without air bubbles.

Asymmetric distortions are also observed when the magic angle is not properly adjusted, or when the observed spin has a spin 1 neighbor (N-14).

- In MAS experiments with narrow lines, small modulations near the peaks indicate coil vibrations or spinner wobble. Refer to the probe troubleshooting section.

- In wideline experiments, there are baseline distortions or additional peaks, usually out of phase. The signals appear also with an empty probe, but reduce to zero amplitude without frequency change when the probe is gradually pulled out of the magnet (usually at frequencies below 50 MHz). These peaks usually come from acoustic ringing. Refer to the probe troubleshooting part and the section I.7, High Power Probes.

Hunting spikes

6.5.4

Spikes are incoherent RF frequencies that are generated by the instrument itself (mixing frequencies, lock, digital bus communication, CPU or microprocessor master clocks) or are present in the environment, or incoherent modulations of RF frequencies used in signal detection. They are picked up somewhere in the detection circuit. Most internally generated stray frequencies do not show up because they are low in amplitude and amplification in the receiver is not high. Since the cabinet provides efficient shielding of the modules inside the console, and all modules are also RF shielded, these stray frequencies hardly are dissipated to the outside if all doors and covers are closed. This also excludes detection of external RF in the SE-451 receiver. When spikes are detected, it should first be tried to get rid of them. If this is not possible, try to find the frequency of the stray frequency to get an indication from where it originates. There are different types of spikes:

- Spikes distributed around the carrier frequency at 50 or 100 Hz distance (60, 120 Hz in the US) are from the AC supply directly (50 or 60 Hz) or after rectification in a DC power supply. If such spikes are present, they are usually independent of the measured NMR frequency, but their size may depend on the rg that is used. Report such spikes to your BRUKER service.

- Spikes that show up in arbitrary places in the spectrum. These spikes result from pick-up of RF frequencies. In such a case, try the following tricks:

- Open up the spectral window as wide as possible, using the FADC if available, start a simple one pulse acquisition with drive power level p1=120 (no pulse) with gs, set rg and the display to observe the stray frequency.

- When the stray frequency can be conveniently observed, change the preamplifier amplification, setting hpprgn to plus. If the signal increases at the same scale as the noise, the stray frequency is picked up before the preamplifier. If it does not increase (the noise grows relative to the signal), it is picked up after the preamp or internally generated in the main rack.

If it is picked up before the preamplifier:

a) Disconnect all transmitter cables to the probe except the observe cable, if the signal remains:

- b) Disconnect heater and thermocouple, if the signal remains:
- c) Disconnect the probe, if the signal remains:
- d) Check for bad contact at the preamplifier matching box, try different preamplifier for the same frequency range, try different matching box with closest frequency range, use fixing screws for preamp matching box to improve ground connection.

If the signal disappears after a), replace all cables consecutively to find the source, then disconnect this cable at the other end, if the signal remains, replace the cable.

If the signal disappears after b), there is probably a bad shielding on a connector or cable

If the signal disappears after c), remove the probe from the magnet and check again.

If the signal is picked up after the preamplifier, disconnect the SE-451 RF in cable. If it remains, call the service. If it goes, reconnect and disconnect the signal out cable at the preamp cover module rear side.

In either case, notify your BRUKER service and report the findings.

Problems with WOBB

6.5.5

Problems with WOBB will occur if:

- a) The output signal for tuning is not strong enough or not there
- b) The reflected signal is not amplified and detected
- c) There is a strong DC offset on the two audio channels.

In case a and b, there will be an error message that the signal amplitude is too weak at $rg=16k$.

With an oscilloscope, check the tune output at the SE-451. There should be a swept frequency (sweep range= $wbsw$)= at a 10-20 mVpp level. If this is correct, case b) is causing the problem. Check whether a strong signal can be observed on the frequency channel using FCU1. Check the tune cable connection to the preamplifier cover module. Check the preamplifier selection. Connect the preamplifier signal out directly to the signal cable into the SE-451 (preamp cover module rear side, thick orange labelled cable).

Other possible problems: WOBB signal detected, but unusually noisy: Most likely the preamplifier was damaged by long high power pulses.

In either case, notify your BRUKER service and report the findings.

SE-451 adjustments

6.6

Adjustments of the SE-451 have been executed upon system installation. Readjustments are only required if new modules are added or replace outdated or defective parts.

The DC adjustment serves to set the DC-offset of both audio channels as close to zero as possible to minimize the center spike and maximize signal dynamic range. It may vary within a tolerable range when the observe frequency or the reference phase on the HPCU keypad are changed. The adjustment procedure is:

set $swh = 125$ kHz, $digtyp = SADC$ or $HADC$. $pulprog = zgadc$, nucleus 1H, $pl1 = 120$, $rg = 128$, $d1 = 100ms$, $td = 4k$, pulse with gs. Set FID display, unshuffled mode, increase vertical display scale until the noise band is observed.

Then adjust channel A and B DC offsets such that the noiseband is in the center of the screen. Increase rg and readjust if necessary. Then, if a FADC is available, set $digtyp$ to FADC, $swh 1e6$ and adjust DC on the FADC board. Since there is no front panel access for these adjustments on the FADC, blind covers of the AQX rack must be removed to the right of the FADC module to get access.

For quadrature adjustment, set up for signal observation on a strong signal with short T1 (protons in pure water). Do 1 scan, at $swh = 125$ kHz, apply 100 Hz line-broadening and ft. Set o1 and the vertical display scale so that the quadimage can easily be observed. Adjust the amplitude and phase balance such that the quadimage is well below 1% of the signal amplitude. Then the quadrature for the FADC is adjusted on the FADC board.

!!! Do the FADC adjustment only if you are confident in doing it, else call the service!!!

Pulse output adjustments

6.6.2

The SE-451 transmitter boards usually put out 1.5Vpp-2.2Vpp RF pulses. This level may be high enough to drive the following stage of the SEU into saturation. In that case, pulse shapes will not be properly amplified.

Feed the ASU output of the frequency channel to adjust into the SE-451 receiver and pulse on the channel using the pulse program viewshape, with a triangular pulse selected. Attenuate the input into the SEU until the shape monitored after phase sensitive detection on the screen (unshuffled mode, receiver phase set for maximum signal in one channel) is truly triangular. In most cases, 3-5 dB attenuation is required.

4-phase modulator adjustments

6.6.3

Please refer to section IV and V for adjustment of the 4-phase modulator on a suitable NMR sample. This adjustment must only be repeated if a new SE-451 or 4-phase modulator board is fitted.

Adding or changing transmitter boards.

6.6.4

If a transmitter board is added into an available slot of the SE-451 (adding a 3rd channel to a 2 channel unit) or if a T-FH board is to be replaced by a T-FX board, the BBIS information prom on the SE-451 must be reconfigured. In `/u/prog/<version>`, start the RXC service tool by typing `/rxc`. Choose submenu 4, SE-451 configuration, and submenu 4, transmitter configuration and specify modifications.

The easiest way of checking whether a pulse program will execute the desired sequence is the pulsdisp routine.

Figure 6.1. The Pulsdisp Routine

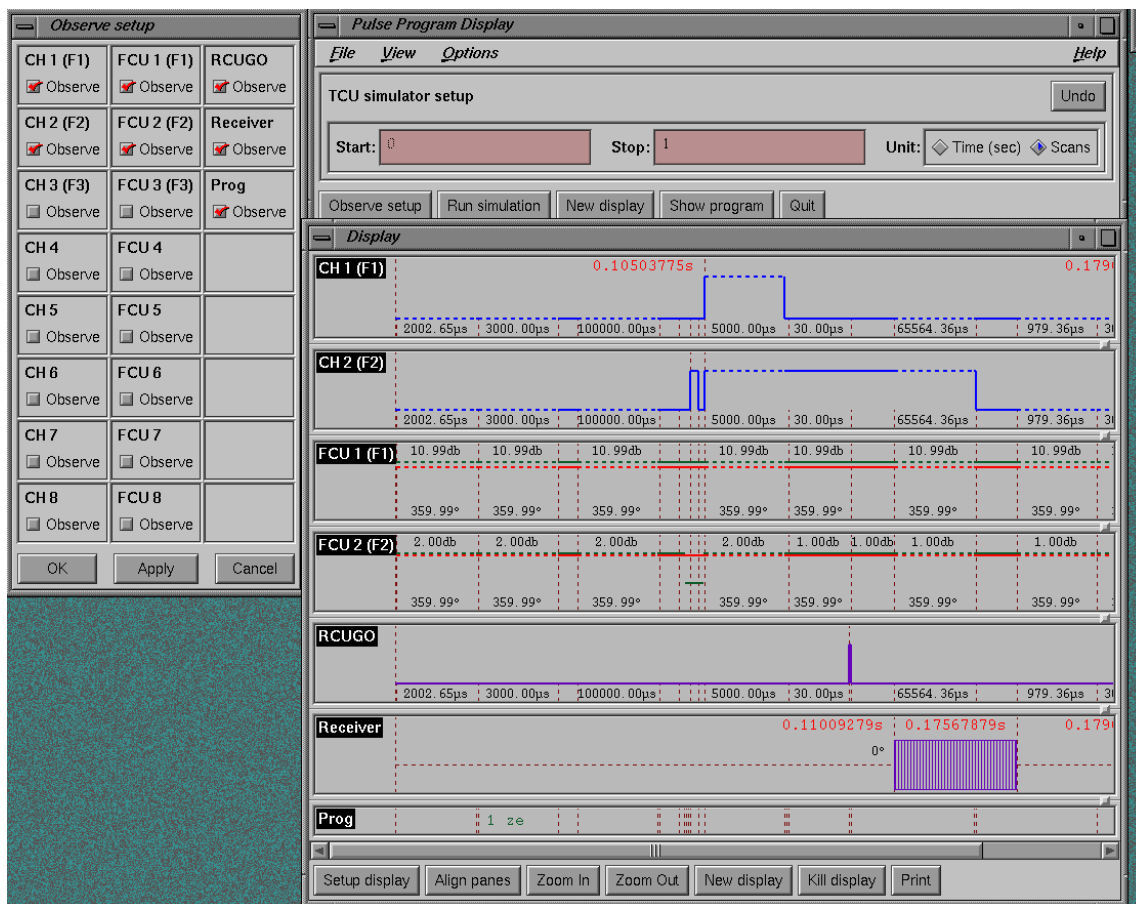

Typing pulsdisp in UXNMR will open up a display window. First one should configure the observe setup in order to specify the number of frequency channels to be tested. Then one should select whether the indication of the pulse sequence should include a certain time or a certain number of scans. Usually, it is sufficient to simulate 1 scan from execution time 0 on. The simulation of a cross polarization sequence is shown in the following picture. It must be remembered that pulsdisp will indicate phases and timings as they are loaded to the TCU and FCU which may deviate in some respects from what is seen in the pulse program. For instance, phase shifts are executed prior to the actual pulse by a time specified in the PHASPR submenu of edskon to allow for propagation times in the synthesizer. This phase preset time will usually be split into several „subdurations“ to blend with proceeding pulse program steps. Phase shifts on frequencies that are subsequently doubled in the synthesizer will show half the programmed phase shift (since the phase doubles with frequency doubling).

Please refer also to the probe operating manual for additional probe specific troubleshooting. Here some general hints will be given.

Probe trouble usually means:

- a) The probe does not tune
- b) The probe arcs
- c) The probe deadtime is too long
- d) The probe shows acoustic ringing

The probe does not tune**6.8.1**

The tuning range of a WB probe is usually given by labels at the protection bar at the probe bottom. The tuning range is factory checked with a reference sample inserted. If very lossy samples (samples with high conductivity, wet samples, samples containing salty solutions) are inserted, the high end tuning frequency may not be achieved any more, or the impedance matching range may be insufficient. In any case, check the tuning of the empty probe first, then, if possible, gradually insert the sample while observing the probe response in WOBB using a large wobble width wbsw. Try to retune as the sample is inserted. In cases where tuning becomes impossible due to the dielectric properties of the sample, reduce the amount of sample either with spacers or by dilution with inert material.

If the probe does not tune even when empty:

- Check whether the WOBB curve shows the preamplifier response (somewhat wavy curve in the upper part of the screen) with wbsw=50.
- Check whether connecting a 50 Ohm impedance instead of the probe brings the line down to the bottom of the screen.
- Check the preamplifier matching box for tight fit
- If the probe was grossly detuned during previous attempts to tune it with sample. Set wbsw to 50 MHz and search for the probe response, changing the center frequency. When found, adjust the matching and tune gradually to the desired frequency. There may be no probe response visible when the matching is turned all the way to one end. In that case, turn the matching to a middle position and search again.
- The probe does not show a response at all:

Check on any other frequency channel if the probe is multiply tuned to check for eventual breaks in the RF circuit. If there is also no response, open up the probe and check the circuitry. If there is a response, try wobbling with another preamplifier on the faulty channel. If no response is found, open the probe and check the circuit. Breaks in the circuit are usually at the coil fixture points, or, in X-wideline probes, at the insert lower contact.

- Check whether the correct coil is mounted in the probe, and whether the plug in selected is correct (X-wideline probe).

Probe arcing is in the most cases caused by dirt in hot spots of the probe.

- Check the compressed gas supply (dryer) for proper function (humidity indicator)
- Open the probe and search for dirt, clean the probe with alcohol and Q-tip or tissue, especially around the coil ends. If the coil is black on one side, check near by surrounding material for black spots as well, try to scrape off the black matter with tissue. Do not bend the coil.

The probe deadtime seems too long**6.8.3**

First try to measure the deadtime signal precisely. Use zgdead to pulse into the empty probe with smallest possible dwell time, digmod=analog, 1 scan. Count the number of bad points at the beginning of the FID and subtract the dwell times accounted for by the pulse and previous delays. Look up the probe Q in the probe test sheet, and calculate the expected deadtime (see chapter I.7). Remember that the deadtime will accumulate like a signal. If the deadtime calculation is far off, check for ringing by repeating the test with the probe outside the magnet (likely for frequencies below 50 MHz). Refer to the following chapter if the deadtime is now in the correct range. If the deadtime looks correct for 1 scan, accumulate 100 scans and measure the deadtime. Then decide whether the probe is suitable for the desired measurement. If the signal amplitude is fairly high, anti-ringing pulse sequences are useful (puls program anti-ring). Otherwise, echo sequences will help because part of the deadtime cancels on consecutive scans.

If the deadtime is prohibitively long for the desired purpose, call the BRUKER applications office for advice.

Acoustic ringing**6.8.4**

If acoustic ringing is encountered, the first easy checks must be whether the ringing comes from the sample or the sample container. First, the electronic deadtime must be measured with the empty probe outside the magnet, then the empty probe in the magnet must be compared with the probe containing the sample and sample container and the probe containing the sample tube only. If there is a difference in ringing (piezoelectric properties of the sample or quartz in the glass tube), a different tube material (plastic) should be used and the sample finely powdered.

If the acoustic ringing comes from the probe, call the BRUKER applications office for advice.

Figures

1	Hardware Description of High Power Components	7
Figure 1.1.	DMX/DSX HP Cabinet 100-400MHz	12
Figure 1.2.	DMX/DSX HP Cabinet AMT 500-600 MHz	13
Figure 1.3.	DMX/DSX HPC 100-400	14
Figure 1.4.	HPCU Keyboard	16
Figure 1.5.	Possible pulse errors	20
Figure 1.6.	Linear Amplification	21
2	Standard Setup Procedures	49
Figure 2.1.	DMX RF Wiring	50
Figure 2.2.	DMX 200, 300, 360, 400 High Power	51
Figure 2.3.	DMX 500, 600 High Power	51
Figure 2.4.	DSX RF Wiring	52
Figure 2.5.	DSX 100, 200, 300, 360, 400 High Power	53
Figure 2.6.	DSX 500 High Power	53
Figure 2.7.	X-observation	54
Figure 2.8.	EDASP menu for a 2H wideline experiment with a DMX 300	55
Figure 2.9.	1H/19F wideline experiments	55
Figure 2.10.	EDASP setup menu for a DMX 300 observing protons	56
Figure 2.11.	EDASP setup menu for a DMX 300 observing fluorine	56
Figure 2.12.	double resonance experiments X-H or X-F	57
Figure 2.13.	EDASP setup menu for a DMX 300 observing C-13 with proton decoupling	57
Figure 2.14.	EDASP setup menu for C-13 observation and proton decoupling	58
Figure 2.15.	EDASP setup menu for a DMX 300 observing C-13 with fluorine decoupling	58
Figure 2.16.	triple resonance experiments X-Y-H	59
Figure 2.17.	EDASP setup menus for a DMX 300 observing C-13	60
Figure 2.18.	EDASP setup menus for a DMX 300 observing N-15	60
Figure 2.19.	B-VT 2000 connections and configuration	62
Figure 2.20.	Pneumatic unit connections	63
Figure 2.21.	Old type with variable loop length	64
Figure 2.22.	New type with variable flow through the exchanger loop	65
Figure 2.23.	New type with variable flow through the exchanger loop	65
Figure 2.24.	New type with variable flow through the exchanger loop	66
Figure 2.25.	Vt Connections For Non-Spinning Probes	67
Figure 2.26.	VT and Pneumatic Connections for Spinning Probes - VTN Design	68
Figure 2.27.	VT and Pneumatic Connections of Spinning Probes - WVT Design	69
Figure 2.28.	VT and Pneumatic Connections for VTN Probes	69
Figure 2.29.	VT and Pneumatic Connections for MAS HT Probes	70

Figure 2.30. MAS Pneumatic Unit Control	72
Figure 2.31. WOBB display of a detuned probe	77
Figure 2.32. WOBB display of a properly tuned probe	77
Figure 2.33. WOBB display of a low Q probe, tuned with a setup sequence 78	
Figure 2.34. Reflected RF Envelope	79
Figure 2.35. Dummy Load Attenuator	81
Figure 2.36. Directional Coupler	81

3 CP-MAS Experiments with WB Probes 83

Figure 3.1. KBr MAS off angle	100
Figure 3.2. KBr MAS on angle	101
Figure 3.3. Adamantane resolution test	102
Figure 3.4. Glycine angle and sensitivity test	103
Figure 3.5. TOSS on glycine	104
Figure 3.6. SELTICS on glycine	105
Figure 3.7. NQS on glycine	106
Figure 3.8. CP/MAS of doubly labeled ammonium nitrate, NH ₄ NO ₃ ...	107
Figure 3.9. N-15 CP/MAS of natl. abundance glycine sensitivity test ...	108
Figure 3.10. Si-29 resolution and sensitivity test of Q8M8	109
Figure 3.11. Si-29 sensitivity test of DSS	110
Figure 3.12. P-31 sensitivity test of ammonium dihydrogen phosphate, ADP, NH ₄ H ₂ PO ₄ 111	
Figure 3.13. Comparison of pulse determination in a solid sample of YAG and in an aqueous solution of Al(ClO ₄) ₃ 112	
Figure 3.14. Processing parameter display (edp) showing the parameters to set up backward linear prediction 113	
Figure 3.15. Comparison of fid's and spectra with and without treatment by backward linear prediction 114	

4 Wideline Experiments on DMX/DSX Instruments 117

Figure 4.1. Pulse Shape	118
Figure 4.2. Preparing a Sample of D ₂ O in a Spherical Sample Cell	119
Figure 4.3. Preparing a Sample of Powdered D-plexiglass	120
Figure 4.4. FID of deuterated plexiglass, quadecho experiment, sampled before echo top 123	
Figure 4.5. Spectrum of deuterated plexiglass, left shifted appropriately ... 124	
Figure 4.6. K-39 in KCl	125
Figure 4.7. P-31 in AlPO ₄	126
Figure 4.8. N-14 in NH ₄ Cl	127
Figure 4.9. Na-23 in NaNO ₃	128
Figure 4.10. H-1 in gypsum powder	129

5 CRAMPS Experiments on DMX/DSX Instruments 131

Figure 5.1. 7mm spinner preparation	132
Figure 5.2. 4mm spinner preparation	132
Figure 5.3. Good Pulse Shape	133
Figure 5.4. MAS spectrum of BaClO ₃ *H ₂ O, 5 kHz rotation	136
Figure 5.5. Amplitude tune pattern	137

Figure 5.6. Tune pattern for - x phase	138
Figure 5.7. Tune pattern for +y, - y phase	139
Figure 5.8. Tune pattern for +x - x sequence (glitch test)	140
Figure 5.9. MREV- 8 or BR- 24 on water, residual glitch measurement	141
Figure 5.10. Offset optimization and calibration with MREV- 8 or BR- 24	142
Figure 5.11. MREV- 8 on glycine powder, CRAMPS probe	143
Figure 5.12. BR- 24 on glycine powder, CRAMPS probe	144
Figure 5.13. BR- 24 on glycine powder, CP probe	145
Figure 5.14. BR- 24 on glycine, phcor4 misadjusted	146
Figure 5.15. BR- 24 on glycine, p4 misadjusted	147
Figure 5.16. BR- 24, digitally filtered, on glycine powder	148

6 Troubleshooting **149**

Figure 6.1. The Pulsdisp Routine	164
--	-----

Tables

1	Hardware Description of High Power Components	7
Table 1.1.	Commonly Used Abbreviations	7
Table 1.2.	Probe Parameters for Quality Factor Q	32
2	Standard Setup Procedures	49
Table 2.1.	PH MAS200-400SB BL4	74
Table 2.2.	PH MAS200-400SB BL7	74
3	CP-MAS Experiments with WB Probes	83
Table 3.1.	Setup samples and conditions for uncommonly observed nuclei 90	
4	Wideline Experiments on DMX/DSX Instruments	117
5	CRAMPS Experiments on DMX/DSX Instruments	131
6	Troubleshooting	149

